

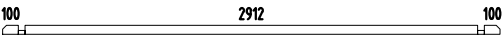

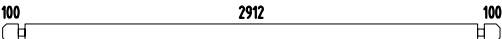

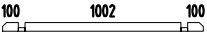

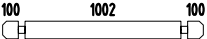

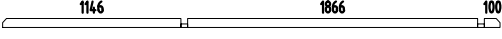

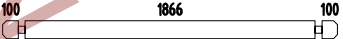
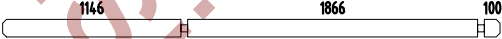
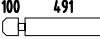



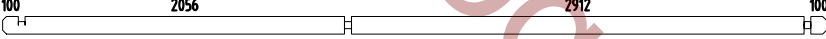

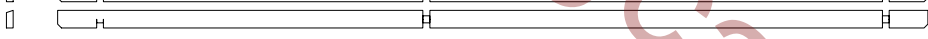

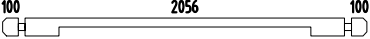
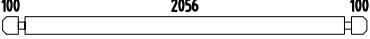
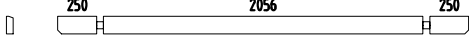
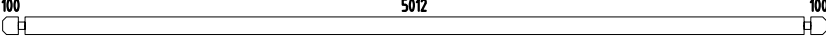
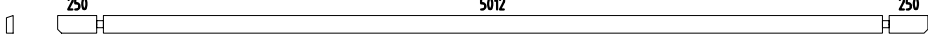
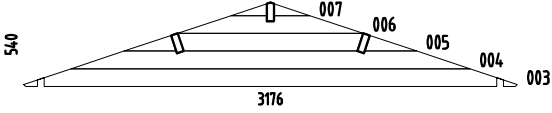
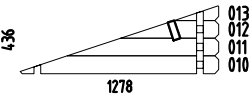
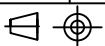
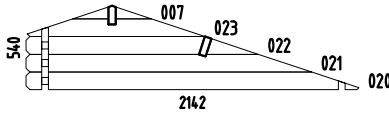
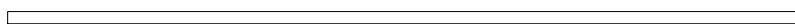

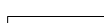
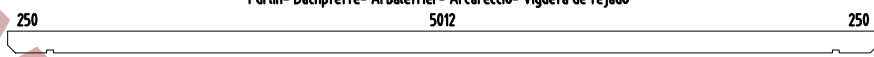
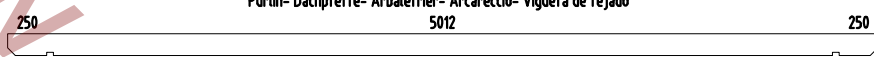
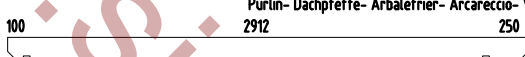



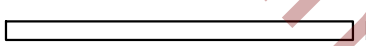

[www.simonskabins.co.uk](http://www.simonskabins.co.uk)

# Gudrum Brunswick Parts and Plans

Pos	SPECIFICATION-STÜCKLISTE-NOMENCLATURE-ELEMENTI-ESPECIFICACIÓN "FRR44-5332-1"	Pcs	Profile (mm)	Length (mm)
001		1	44x57	3200
002		24	44x114	3200
008		1	44x57	1290
009		17	44x114	1290
014		1	44x57	3200
015		6	44x114	265
016		4	44x114	2154
017		3	44x114	3200
018		18	44x114	635
019		1	44x114	3200
024		18	44x114	475
025		9	44x114	475
026		1	44x114	5300
027a		1	44x114	5600
027b		1	44x114	5600
028		34	44x114	362
029		1	44x114	2344
030		2	44x114	2344
031		1	44x114	2644
032		17	44x114	5300
033		1	44x114	5600
W1-1		1		
W2-1		1		

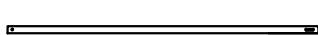
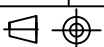

Pos	SPECIFICATION-STÜCKLISTE-NOMENCLATURE-ELEMENTI-ESPECIFICACIÓN "FRR44-5332-1"	Pcs	Profile (mm)	Length (mm)
W3-1		1		
AR1	Foundation- Fundament- Fondazione- Vigas de cimentación 	2	60x80	5090
AR3	Foundation- Fundament- Fondazione- Vigas de cimentación 	10	60x80	2870
AR2	Foundation- Fundament- Fondazione- Vigas de cimentación 	3	60x80	626
PR2	Purlin- Dachpfette- Arbalétrier- Arcareccio- Vigueta de tejado 250 5012 250 	1	44x140	5600
PR3	Purlin- Dachpfette- Arbalétrier- Arcareccio- Vigueta de tejado 250 5012 250 	1	44x140	5600
PR1	Purlin- Dachpfette- Arbalétrier- Arcareccio- Vigueta de tejado 100 2912 250 	1	44x140	3350
060	Floor board- Fussbodenbrett- Madrier du plancher - Tavola pavimento- Tabla de suelo 	21	89x19	5005
061	Floor board- Fussbodenbrett- Madrier du plancher - Tavola pavimento- Tabla de suelo 	12	89x19	2905
062	Terrace board- Terrassenbrett- Madrier de terrace- Tavola terrazzo- Tabla de terraza 	11	95x19	2050
070	Roof board- Dachbrett- Madrier du toit- Tavola tetto- Tabla de tejado 	126	89x19	1900
120	Diamond- Deckbrett- Madrier- Tavola di copertura- Rombo 	2	19x140	300
090	Eave edging- Dachrandbrett- Madrier en bordure du toit- Tavola bordo tetto- Tabla de valadizo 	4	16x95	2800
100	Facia board- Giebelblende- Écran frontal- Schermo frontone- Tabla de facia 	4	16x120	1940
130	Floor beading- Fussbodenleiste- Baguette du plancher- Listello pavimento- Listón de suelo 19x45 	6	19x45	2912
160	Post- Pfosten- Poteau- Montante- Poste 70x70 	1	70x70	1990
080	Roof edge reinforcement- Dachrandleiste- Baguette en bordure du toit- Rinforzo bordo tetto- Refuerzo borde tejado 	2	32x40	2650
081	Roof edge reinforcement- Dachrandleiste- Baguette en bordure du toit- Rinforzo bordo tetto- Refuerzo borde tejado 	2	32x40	2950
Sis1	Side slat- Randleiste- Baguette en bordure- Listón de borde- Listello bordo 	6	19x70	846
Sis2	Side slat- Randleiste- Baguette en bordure- Listón de borde- Listello bordo 	12	19x70	1018
Sis3	Side slat- Randleiste- Baguette en bordure- Listón de borde- Listello bordo 	6	19x95	986
156	Slat- Leiste- Baguette- Listello- Listón 	1	19x45	1620
140	Storm brace- Sturmleiste- Protection contre le vent- Antivento- Protector contra tormentas 	4	25x45	2000
	Object name "FRR44-5332-1"	Page 2/4		

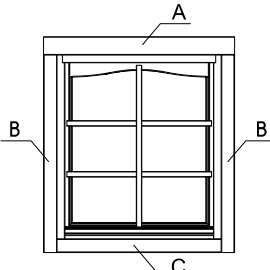
Pos	SPECIFICATION-STÜCKLISTE-NOMENCLATURE-ELEMENTI-ESPECIFICACIÓN "FRR44-5332-1"	Pcs																															
Fim	-Fixing kit- Befestigungsset- Moyens de fixation- Materiale di fissaggio- Kit de fijación	1	USE																														
QPUP 08x80	Bolt -Schloss-schraube -Boulon- Bullone- Perno- M8x80mm PUP0	8	140																														
QULSy damik 30/35	Cylinder- Zylinderschloss- Serrure a mortaiser- Serratura a cilindro- Bombin- 30.35	1	TU44-7R																														
QULKaf eHOBEk	Door fittings- Türbeschlag- Ferrure- Ferramenta porta- Manilla puerta- QULKateHOBEk	1	TU44-7R																														
QULli nkHOBE	Door fittings- Türbeschlag- Ferrure- Ferramenta porta- Manilla puerta- QULlinkHOBE	1	TU44-7R																														
QServa riiviv astus160	Keeper- Schliessblech- Tole- Lamiera- Aldaba de candado	1	TU44-7R																														
QNU35 35130	L-iron- Winkel- Angle -Angolo- Angulo 35x35x130 EM VN353590	3	160																														
QNA1 4x40M	Nail- Nagel- Clou- Chiodo- Clavo- 1.4x40mm	40	130																														
QNA2 2x50Zn	Nail- Nagel- Clou- Chiodo- Clavo- 2.5x50mm	700	060; 061; 062; 070																														
QNA4x 120ZN	Nail- Nagel- Clou- Chiodo- Clavo- 4x120mm	26	ARx																														
QMU8	Nut- Schraubenmutter- Écrou- Dado- Tuerca- M8mm	8																															
QKR3 x16kZN	Screw- Schraube- Vis- Vite- Tornillo- 3x16mm	2																															
QKR3 5x40ZN	Screw- Schraube- Vis- Vite- Tornillo- 3.5x40mm	120	080; 090; 100; ...																														
QKR3 x20ZN	Screw- Schraube- Vis- Vite- Tornillo- 3x20mm	30	TU44-7R; A44-6x																														
QKR4 5x50ZN	Screw- Schraube- Vis- Vite- Tornillo- 4.5x50mm	100	SiSx																														
QKR4 5x70ZN	Screw- Schraube- Vis- Vite- Tornillo- 4.5x70mm	25	001; 008; 014; 027; 031; 033; PRx; ...																														
QKR5 x90ZN	Screw- Schraube- Vis- Vite- Tornillo- 5x90mm	6	TU44-7R; 160																														
QSE8x22	Washer- Dichtscheibe- Joint- Rondella- Arandela- 8x22mm	8																															
QALLi nkHOBE	Window fittings- Fenstergriff- Poigne de la fenêtre- Maniglia finestra- Manilla (ventana)	3	A44-6x																														
A44-6L	Window - Fenster - Fenetre - Finestra-Ventana 882x990   <table border="1" data-bbox="638 1803 1053 2027"> <thead> <tr> <th colspan="6">Side slat- Randleiste- Baguette en bordure- Listón de borde- Listello bordo</th> </tr> <tr> <th>Pos</th> <th></th> <th>(mm)</th> <th>(mm)</th> <th>(mm)</th> <th>(pcs)</th> </tr> </thead> <tbody> <tr> <td>Sis ...</td> <td>A</td> <td>19</td> <td>95</td> <td>986</td> <td>2</td> </tr> <tr> <td>Sis ...</td> <td>B</td> <td>19</td> <td>70</td> <td>1018</td> <td>4</td> </tr> <tr> <td>Sis ...</td> <td>C</td> <td>19</td> <td>70</td> <td>846</td> <td>2</td> </tr> </tbody> </table>	Side slat- Randleiste- Baguette en bordure- Listón de borde- Listello bordo						Pos		(mm)	(mm)	(mm)	(pcs)	Sis ...	A	19	95	986	2	Sis ...	B	19	70	1018	4	Sis ...	C	19	70	846	2	2	
Side slat- Randleiste- Baguette en bordure- Listón de borde- Listello bordo																																	
Pos		(mm)	(mm)	(mm)	(pcs)																												
Sis ...	A	19	95	986	2																												
Sis ...	B	19	70	1018	4																												
Sis ...	C	19	70	846	2																												

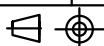

SPECIFICATION-STÜCKLISTE-NOMENCLATURE-ELEMENTI-ESPECIFICACIÓN  
"FRR44-5332-1"

Pcs

A44-6R

Window - Fenster - Fenetre - Finestra-Ventana 882x990

1

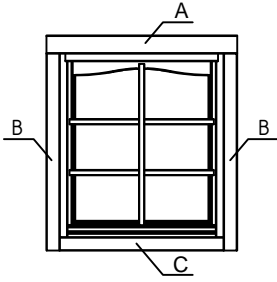

Side slat- Randleiste- Baguette en bordure-  
Listón de borde- Listello bordo

	Pos	(mm)	(mm)	(mm)	(pcs)
Sis ...	A	19	95	986	2
Sis ...	B	19	70	1018	4
Sis ...	C	19	70	846	2

TU4  
4-7R

Door - Tür - Porte - Porta-Puerta 1610x1936

1

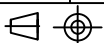
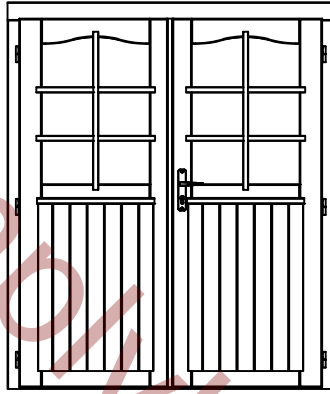

www.Simplylogcabins.co.uk

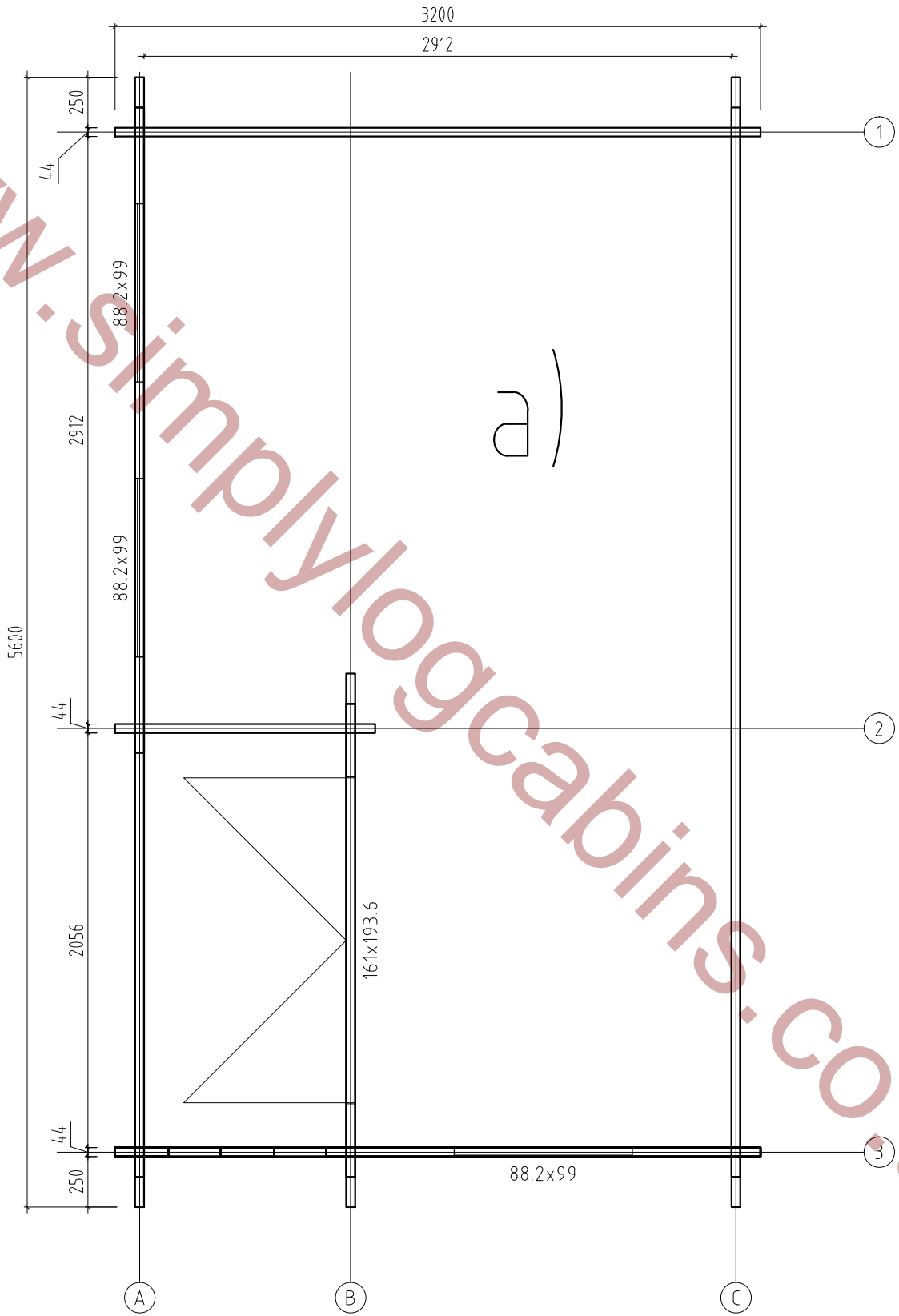

www.Simplylogcabins.com

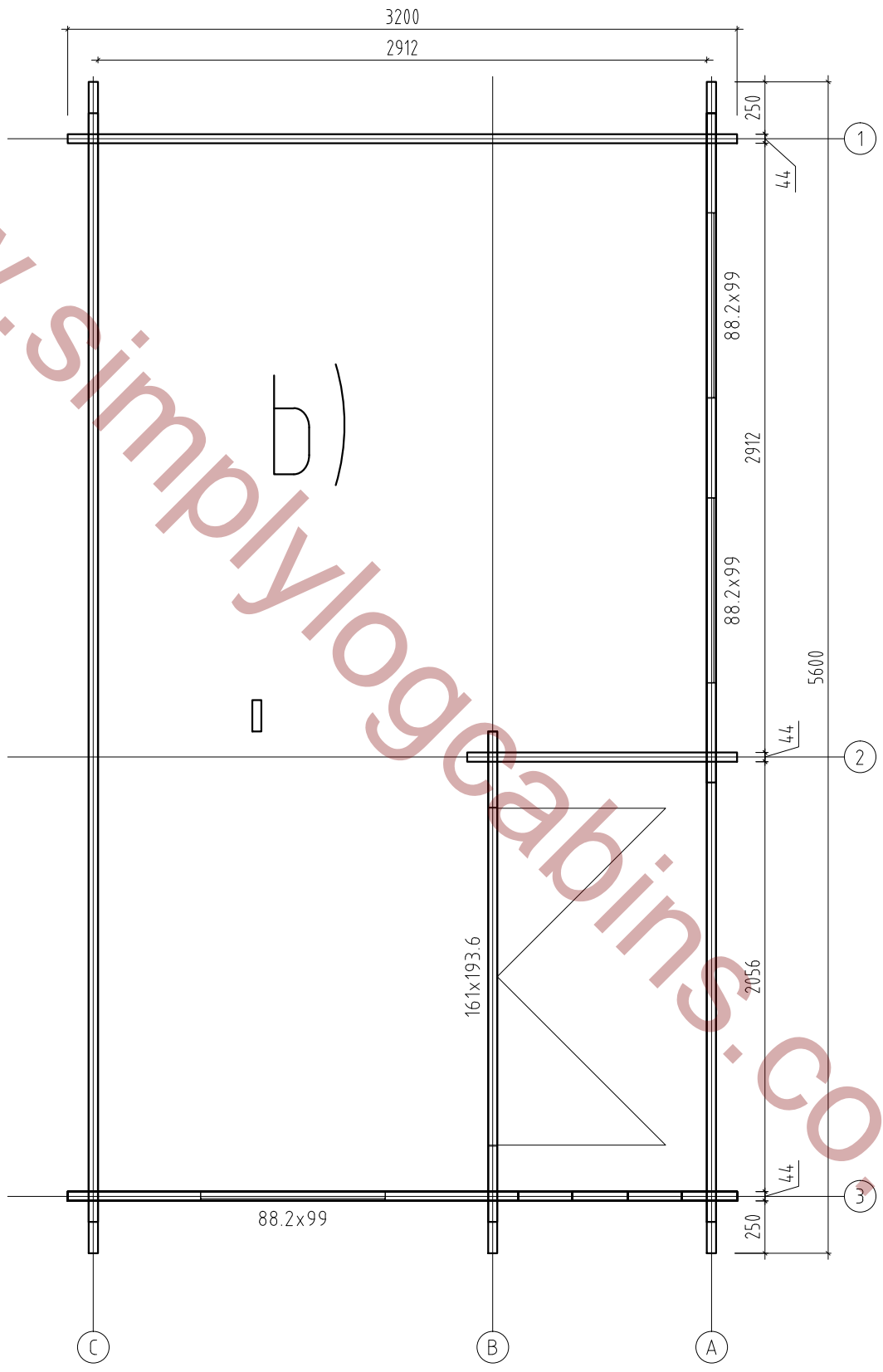

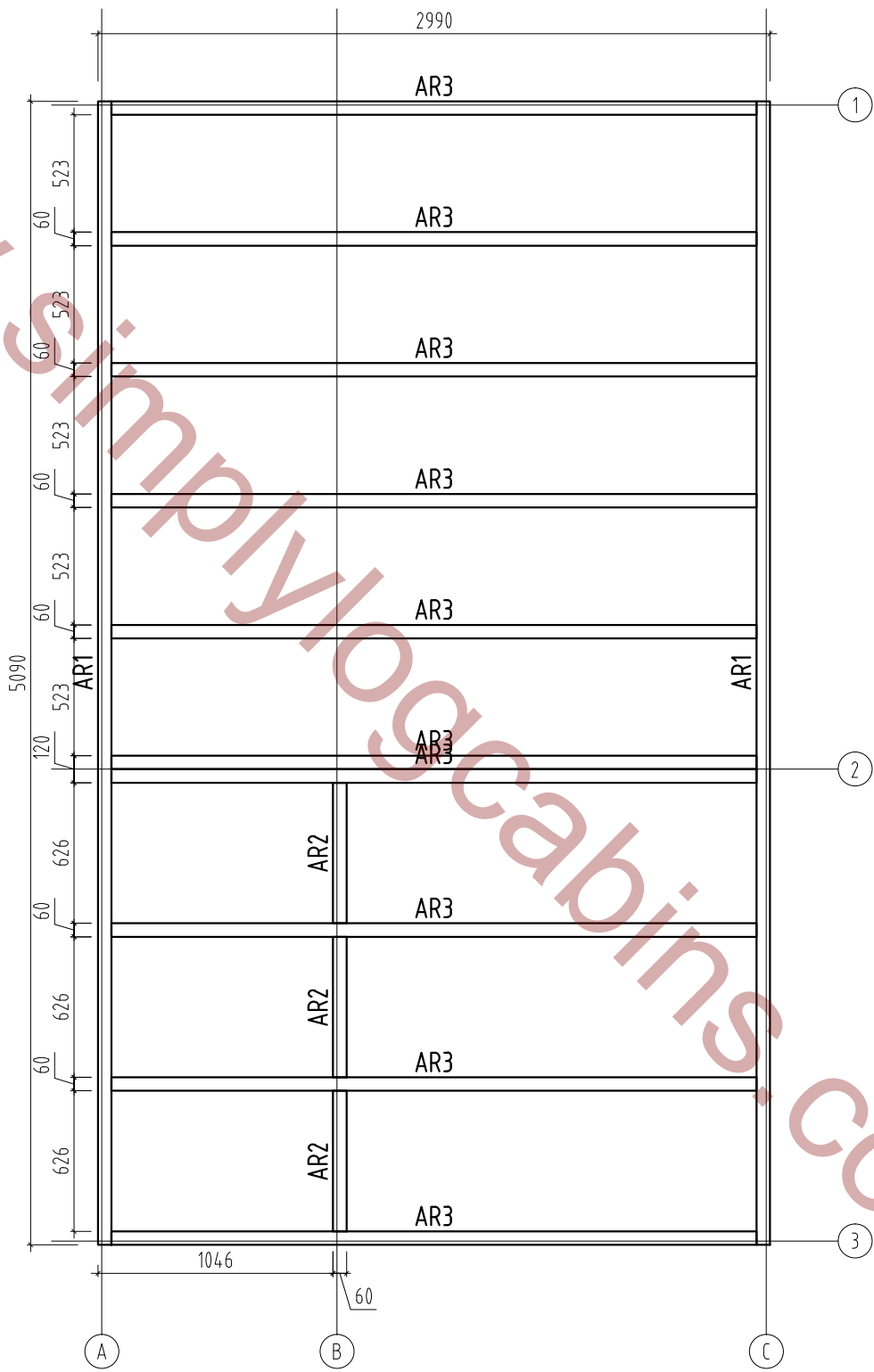

[www.SimplyLocCabins.co.uk](http://www.SimplyLocCabins.co.uk)



[www.simplyscapings.co.uk](http://www.simplyscapings.co.uk)

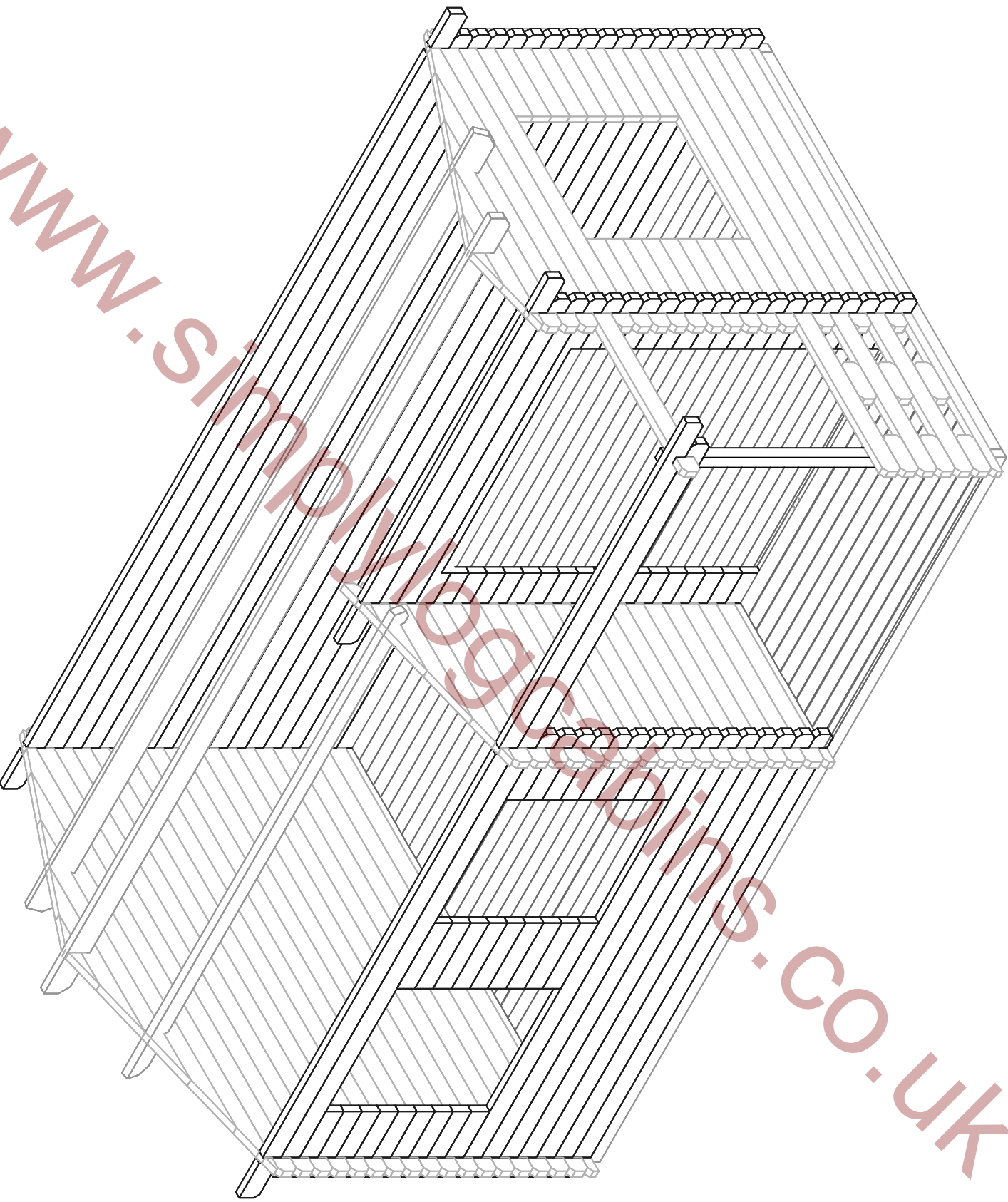

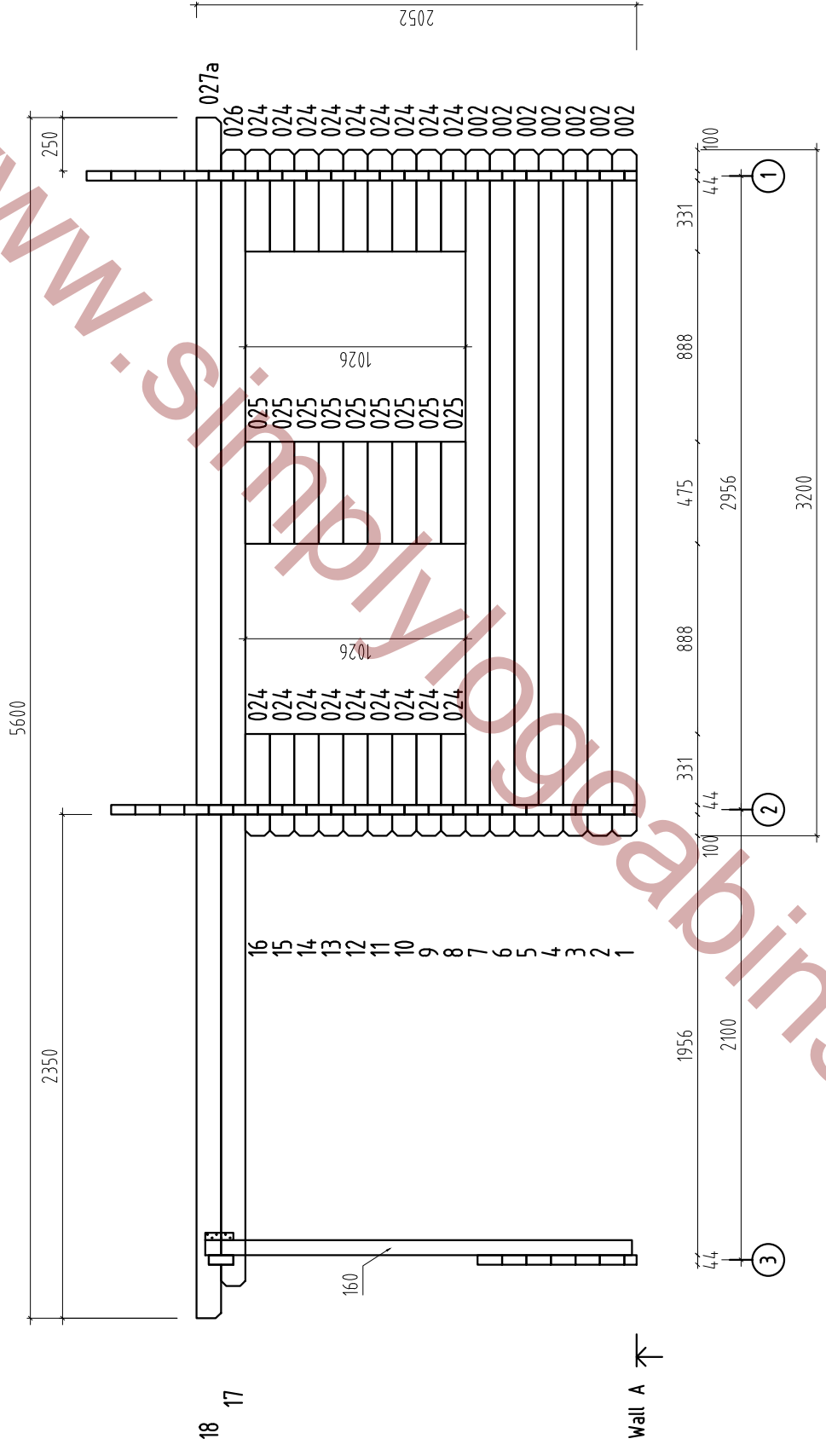

www.simplesupplies.com.uk

www.simply101.com

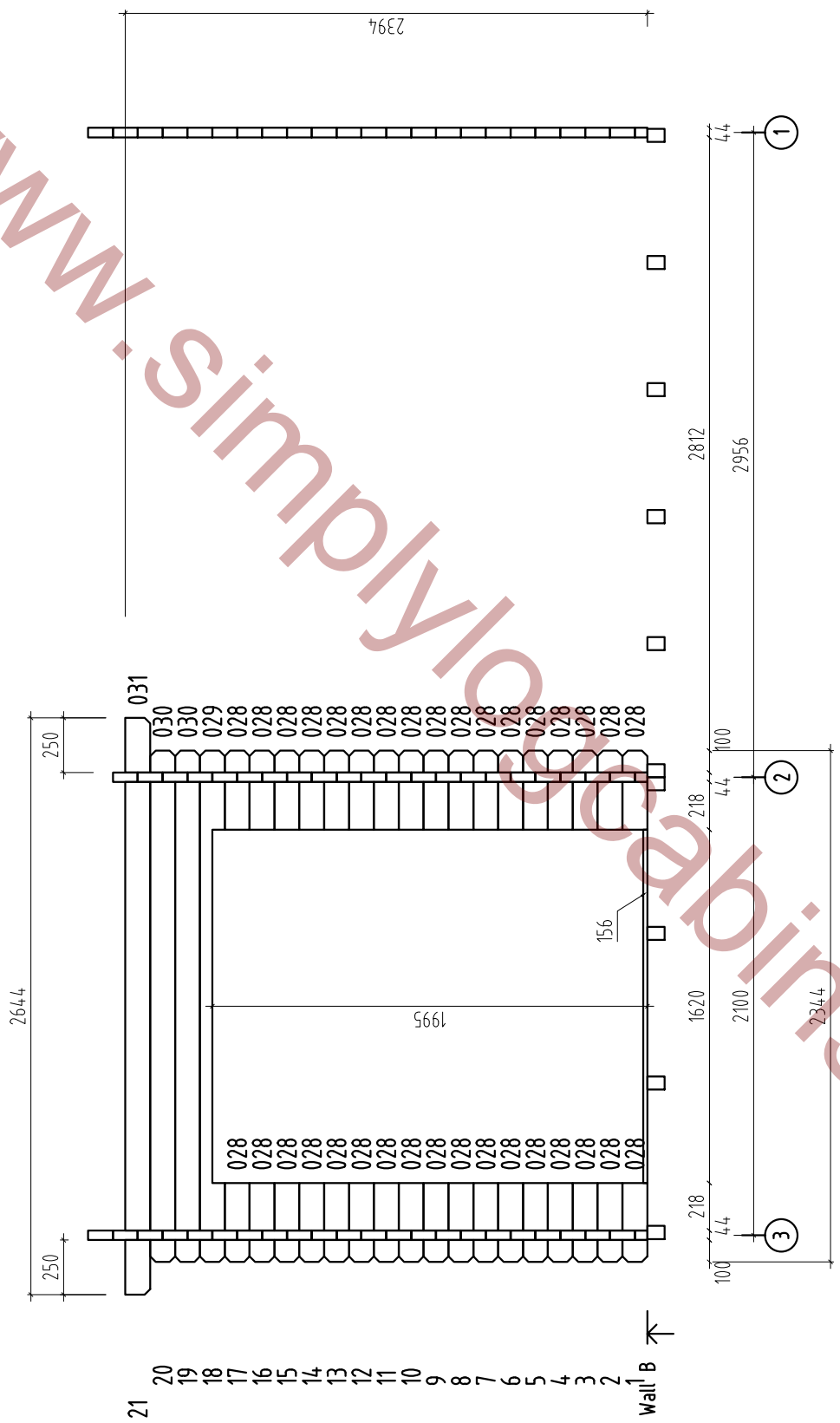

- 21
- 20
- 19
- 18
- 17
- 16
- 15
- 14
- 13
- 12
- 11
- 10
- 9
- 8
- 7
- 6
- 5
- 4
- 3
- 2
- 1

Wall B →

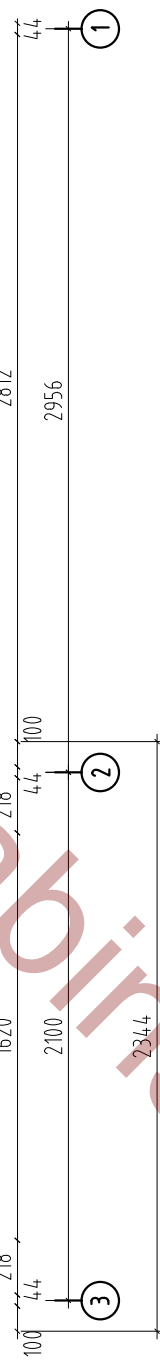

www.simplicitycabinets.com

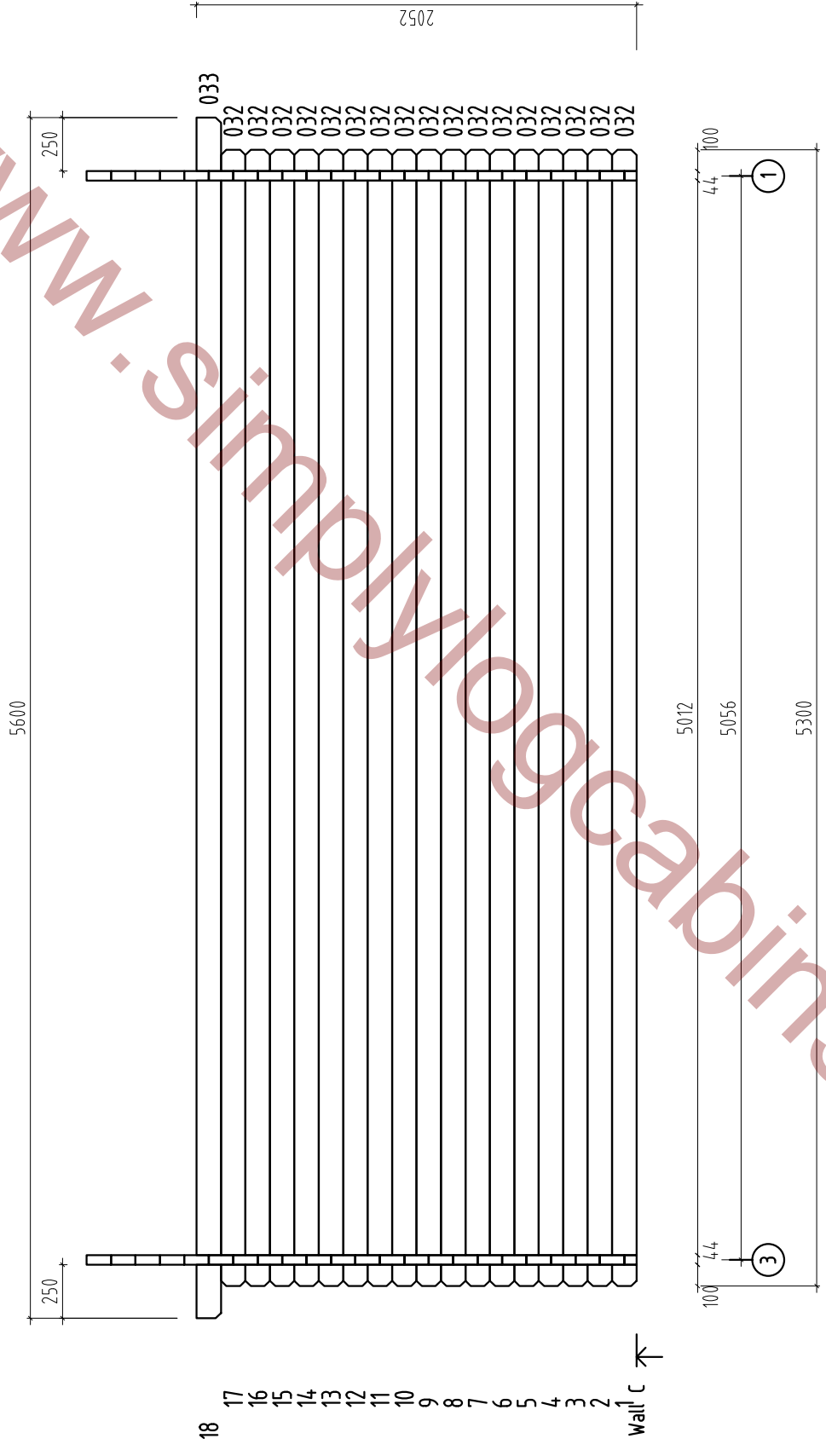

5600

250

18

17

16

15

14

13

12

11

10

9

8

7

6

5

4

3

2

Wall C ↗

033

032

032

032

032

032

032

032

032

032

032

032

032

032

032

032

032

032

5012

5056

5300

100

44

③

44

100

①

2052

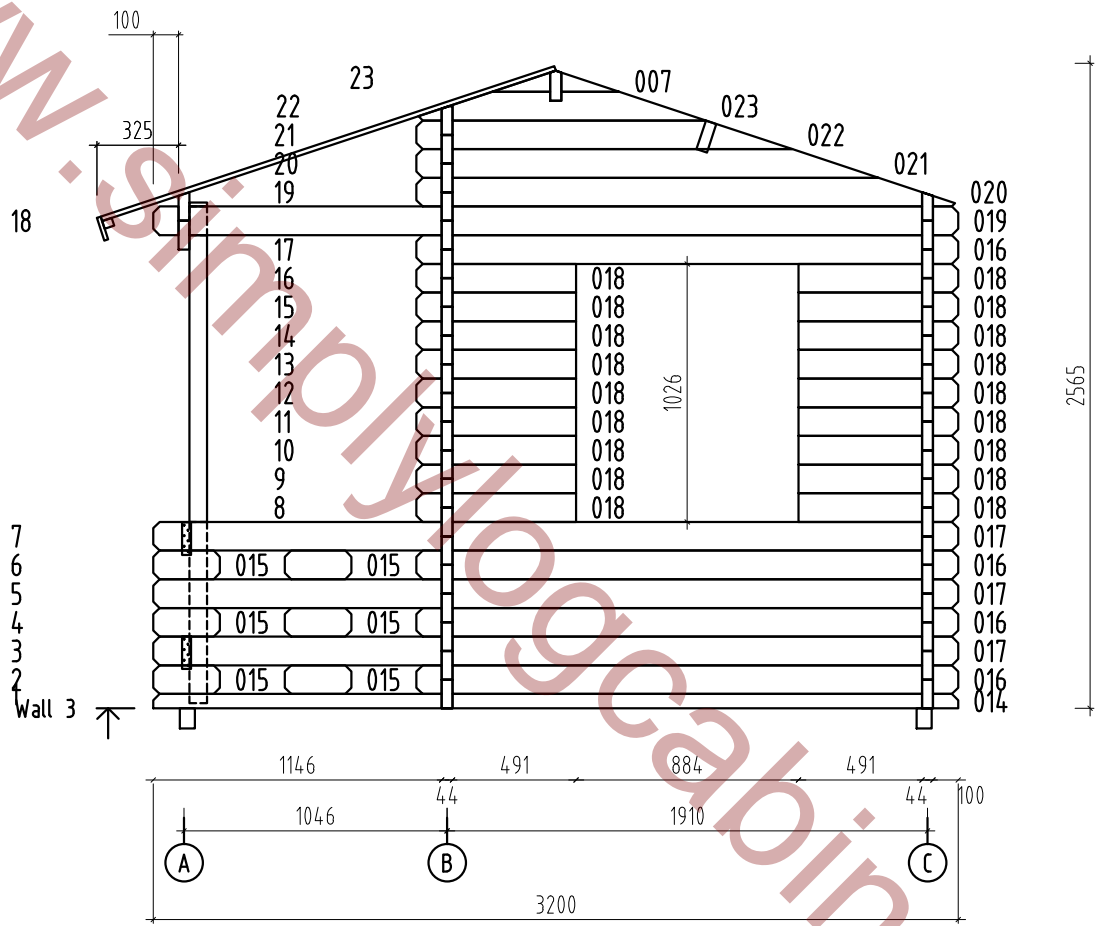

www.knablogcabins.co.uk

www.SimpleCabinets.co.uk

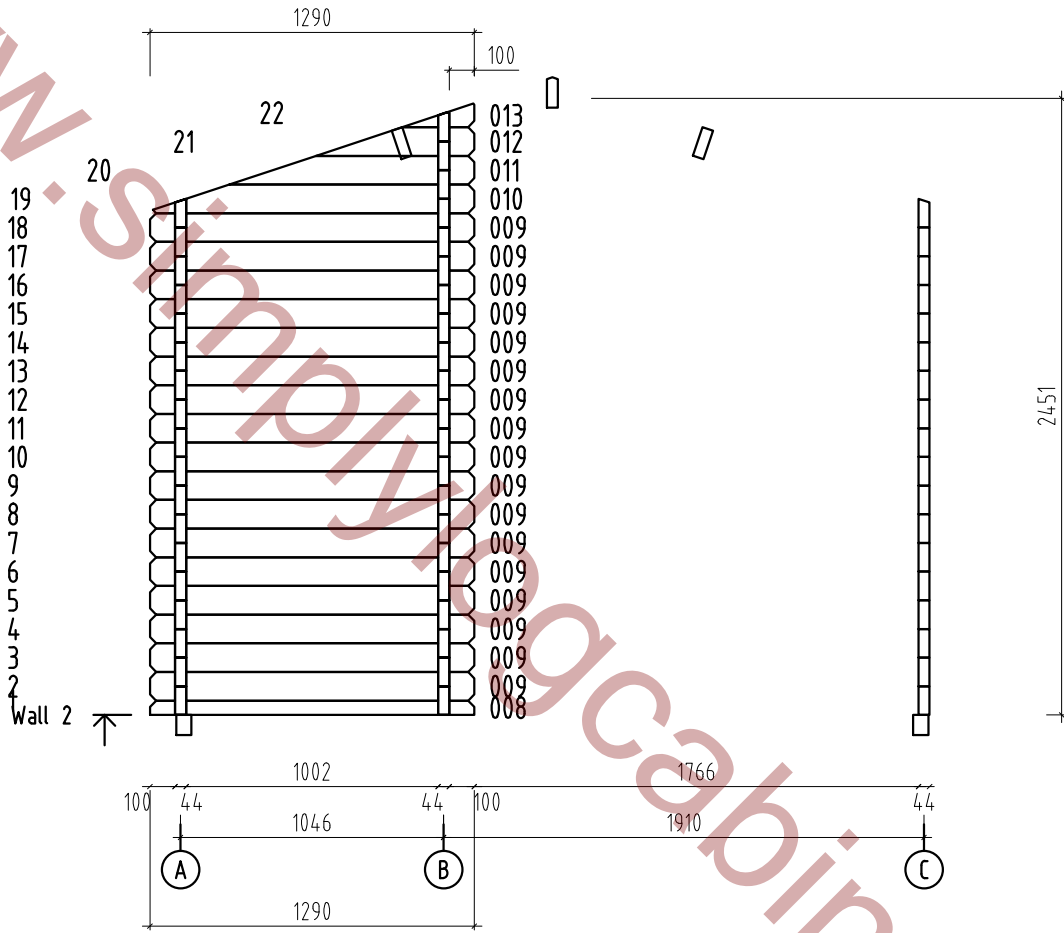

www.SimpleLogCabins.co.uk

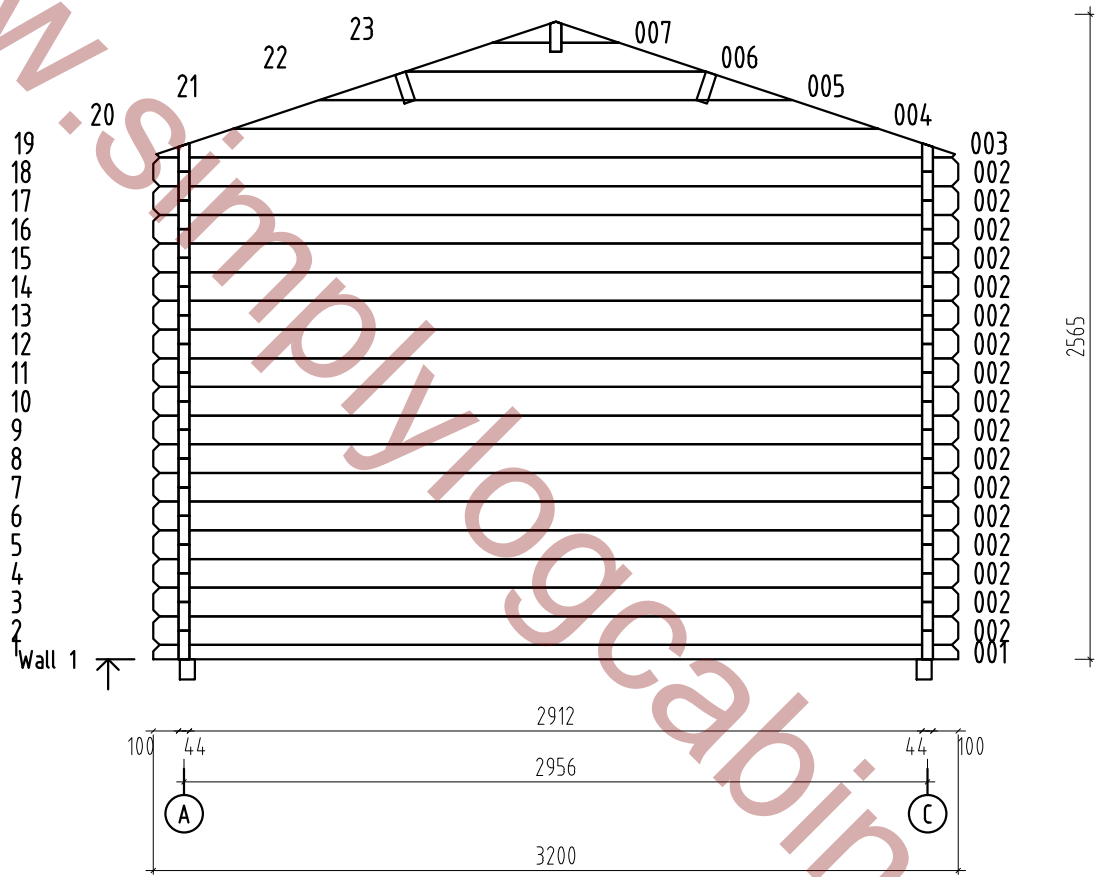

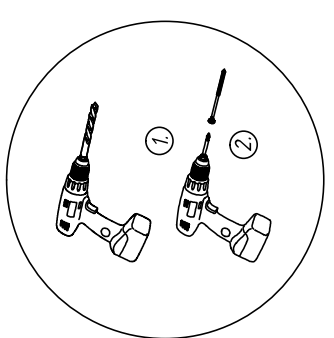
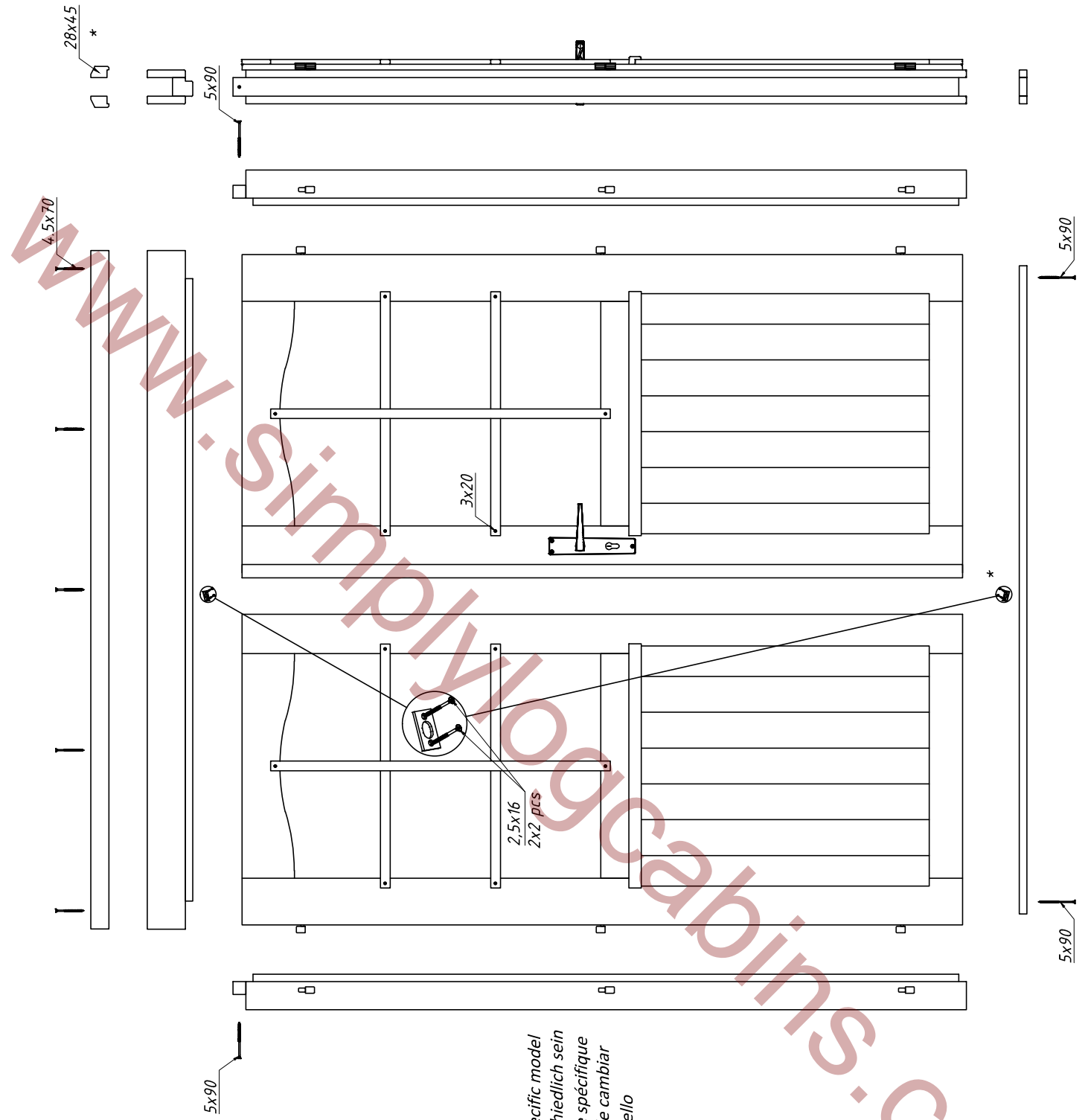

\* The specification may vary depending on the specific model  
 \* Die Spezifikation können je nach Modell unterschiedlich sein  
 \* Les spécifications peuvent varier selon le modèle spécifique  
 \* Dependiendo del modelo, la especificación puede cambiar  
 \* Le specifiche possono variare a seconda del modello

www.simplifly.com