

# SHIRE

BUILT AROUND OUR REPUTATION

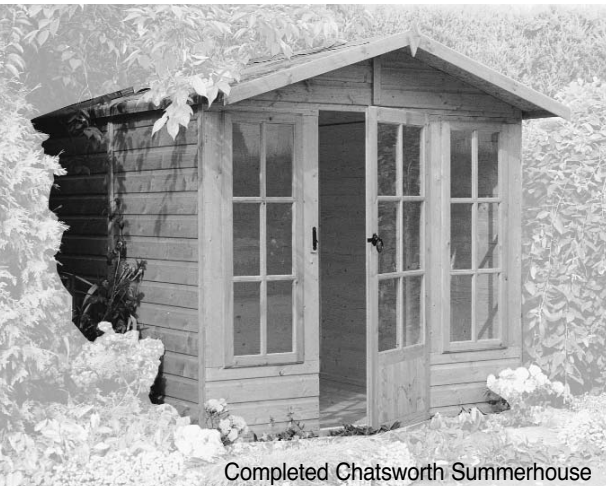

Completed Chatsworth Summerhouse

## Assembly of Chatsworth Summerhouse®

Thank you and congratulations on the purchase of your Shire Garden Building. We believe that this product will give you many years of excellent service. This is a natural product manufactured to a high standard therefore if you have any queries or experience any difficulties then please contact our customer service hotline on **01945 465295**.

### Preparation of Base

We recommend that the base onto which your building will stand should be at least 75mm larger in each direction than the total floor size of the building.

Actual floor area of the building: 1980 x 2050mm

Total height clearance: 2140mm

The chosen position in your garden for the siting of the building should be excavated to a depth of 75mm to allow a base of sand, on to which paving slabs can be evenly laid - **THEY MUST BE LEVEL AND FIRM.**

### Treatment/Care of your Garden Building

Treat with a suitable decorative wood finish immediately. We recommend that all timber pieces be treated again prior to assembly and again within 3 months of assembly. We further recommend that all pieces are treated again at least annually or as frequently as the instructions on the product used recommends.

We would suggest that all wall panels be treated in an upside-down position to allow the finish/treatment to ingress into the tongue and groove jointing.

We would also remind you that you would rarely (if ever) be able to re-treat the underside of the floor following assembly. We strongly recommend that the underside of the floor is treated an absolute minimum of twice (not including pre-treatment).

### Tools Required

- Posidrive screwdriver (electric is best)
- Drill, 6mm drill bit and 8mm drill bit
- Hammer
- Sandpaper (to smooth any rough edges)
- Cutting knife
- Tape measure
- Step ladder
- Ruler
- Pencil
- Saw

### IMPORTANT!

#### PLEASE READ PRIOR TO ASSEMBLY OF THE BUILDING

EVERY PRECAUTION IS TAKEN TO ENSURE THAT YOUR BUILDING HAS NO ELEMENT INCORRECTLY PLACED OR POSSIBLY HAZARDOUS, HOWEVER PRIOR TO USE PLEASE CHECK ALL SURFACES FOR THE FOLLOWING:

- 1 RAISED GRAIN, SPLINTERS: sand down timber to smooth finish
- 2 NAIL/SCREW/PIN HEADS PROUD: tap home to be flush with surface of timber
- 3 DAMAGED SCREW HEADS RESULTING IN SHARP SPLINTERS OF METAL: replace
- 4 SHARP ENDS OF NAILS/ SCREWS/ PINS PROTRUDING THROUGH THE PANEL: remove and reposition.
- 5 ENSURE ALL PARTS ARE SECURED AGAINST REASONABLE FORCE: remove and refit
- 6 ENSURE THERE ARE NO LOOSE PARTS: remove and refit/discard

**WE RECOMMEND THAT PROTECTIVE GLOVES BE WORN THROUGHOUT**

### PLEASE NOTE

Wood is a natural product and is therefore prone to changes in appearance, including some warping, movement and splitting, particularly during unusual climatic conditions (long hot or wet spells of weather). As a natural occurrence this is not covered by a guarantee.

### Parts List

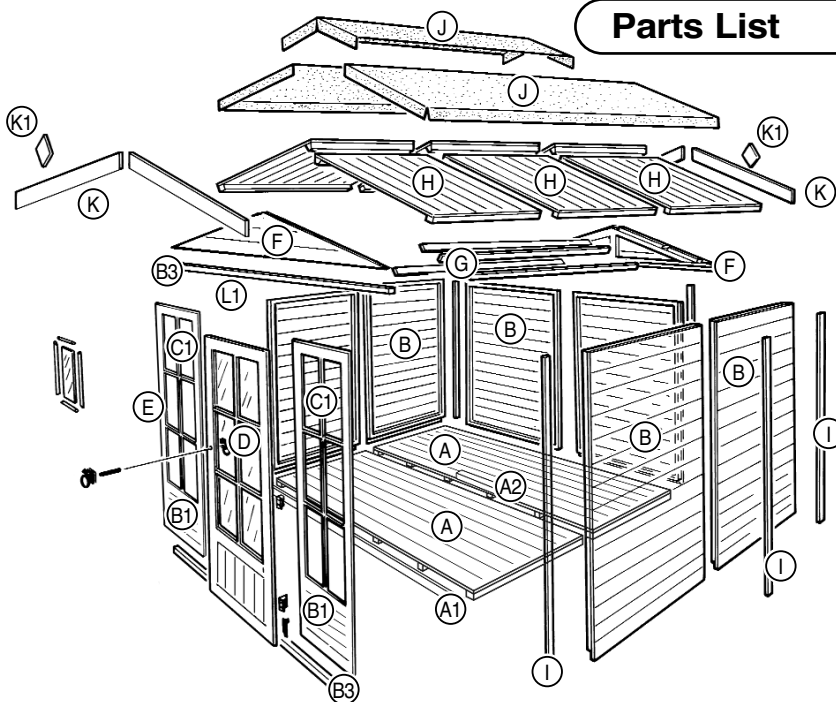

PLEASE LAY OUT PARTS AND CHECK OFF AGAINST CHECK LIST BELOW:

#### QTY DESCRIPTION

2	Floor panels	A
2	Framework 34x46x 1980 mm (floor edge)	A1
5	Framework 34x46x 345 mm (between floor joists)	A2
6	Plain Side Panels	B
2	6 Pane Window Panels (wings)	B1
2	Framework 44x44x 1980 mm	B3
1	Window frame insert	C1
1	RH Door	D
2	Gable sections	F
4	Roof bearers 34x34x 2070 mm	G
6	Roof panels	H
1	Roof overhang coverstrip	H4
7	Coverstrips	I
1	Roll felt 5 mtr long x 1 mtr wide	J
1	Roll felt 2.5 mtr long x 0.5 mtr wide	J
4	Plain fascia	K
2	Diamonds	K1
6	Panes door glazing material - 268 x 373 mm	L
12	Beading 270 mm long approx	M
12	Beading 377 mm long approx	M
12	Panes window glazing - 375 x 175 mm	
24	Beading 177 mm long approx	
24	Beading 377 mm long approx	

#### QTY DESCRIPTION

7	Window/door hinges
2	Casement stays
4	Casement stay pins
1	Gate latch set
83	25mm screws
68	60mm screws
2	80mm screws
129	40mm nails
8	10mm screws
10	25mm black screws
4	50mm nails
130	Felt nails
144	Panel pins

**A - Floor Assembly**

1. Take one floor panel 'A' and a piece of framework 34x46x1980 mm approx 'A1'. Place the framework on the edge of the floor so that the framework is flush and level with the boarding and joists. Mark where the floor joist meet the framework and mark. Drill at these marks. Secure to floor using 6x 60 mm screws.



2. Repeat item 1 with one more floor section.

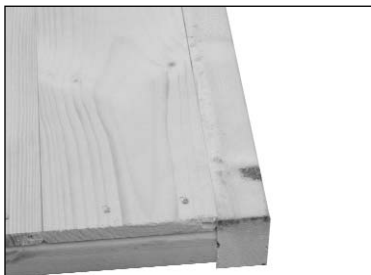

3. Place floors on your firm level base, board side up. Take 5 pieces framework 'A2', 34x46x345 'A2' and place between each floor joist. Nail half of the widest part to the floor using 3x 40 mm nails per piece.



4. Once all frameworks are fitted between floor joists slide another floor on top of the framework and secure again using 3x 40 mm nails per floor joist.



**B - Fit Window Insert C1 (from top)**

1 Place one hinge on the inner rebate part of the top of the window. The rounded part of the hinge should sit above the outer edge of the window. Screw the inner piece into position using the pre drilled holes in the hinge and 2x 25mm screws. Repeat.



2 Place the window into the aperture. Secure the window to the panel using 3x 25mm screws per hinge, again through the predrilled holes in the hinge. Repeat.



3 Open the window and fit a further 2x 25mm screws per hinge next to the one already fitted in Step 1. Repeat.

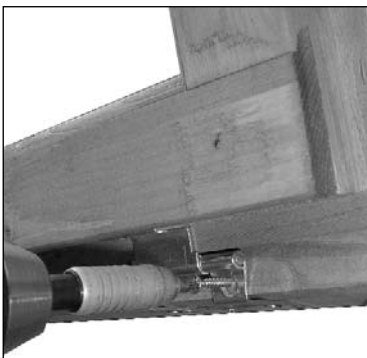

4 **Fitting the Casement Stay.** Place the casement stay centrally on the inside of the window. Place the 2 pins under the casement stay. Position so that it is not resting on the framework of the panel and not so high that the pins are of no use.

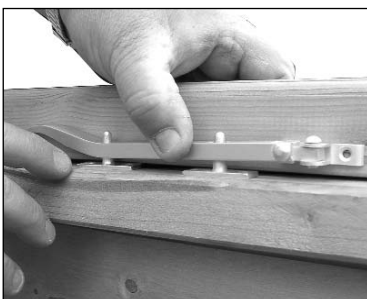

5 Fit the Casement Stay on the window using 2x 25mm screws.



6 Mark where the 'pins' will be placed.



7 Secure into position using 4x 25mm screws - 2 in each pin.



**C - Front Assembly**

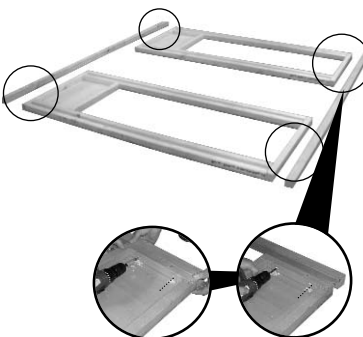

1 Lay wing panels 'B1' on a flat, clean surface with framework facing upwards.

2 Take two lengths of framework 'B3' 44x44 x 1980 mm. Place one at each end of wing panels 'B1', to run flush with both outer edges of parts 'B1'.

3 The horizontal gap where the doors are to go should measure approx. 676 mm.

4 Drill/screw parts 'B3' and 'B1' at both ends using a total of 8x 60 mm screws.

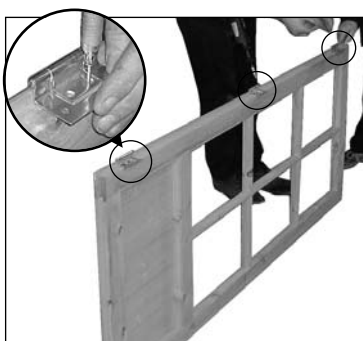

5 Three hinges need to be spaced along the door – one centrally, one towards the top and one toward the bottom. Place one hinge on the inner rebated part of the edge of the door. Screw the inner piece of one into position using the pre drilled holes in the hinge and 2x 25 mm screws. Repeat for other two hinges on door.



6 Place the door 'D' on a flat, level surface with the inside facing upwards. Place wing panel assembly on top of the doors so that the doors fit inside the aperture.

7 Secure the doors to the panel using 1x 25 mm screw per hinge through the predrilled centre holes of each hinge. Repeat for all hinges.

8 Open the door fully and fit a further 3x 25mm screws per hinge.

**D - Wall Assembly**

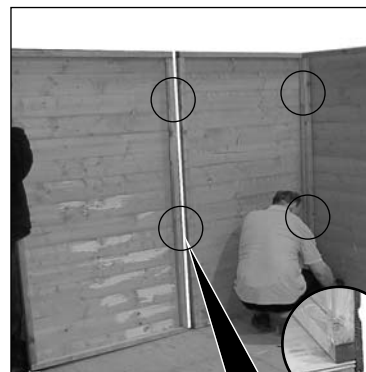

1. Decide where the window panel is to go. Place one side panel 'B' on the floor at the right hand corner. Place a further panel 'B' inside the panel already in place. THE PANELS ALONG THE BACK WALL SHOULD EXTEND FROM FLOOR EDGE TO FLOOR EDGE. The panels to go at the side screw TO and fit INSIDE the panels to go at the back.

2. Drill 2 holes, one to the top and one to the bottom. Do not drill into adjacent panels. Secure the panels together using 2x 60 mm screws.

3. Repeat for all plain side panels and also complete front assembly.

### E - Gable Assembly

1. Place one gable section 'F' on top of the back walls. Drill 4 times along the length and secure using 4x 60 mm screws.

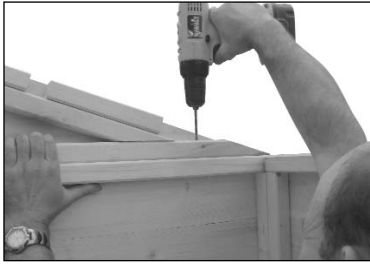

2. Repeat at front.

### F - Fit Roof Bearers

1. Take 4 roof bearers 34x34x 2070 mm 'G'.
2. Place in opposite guide holes of both gables.
3. Drill and screw bearer to gable using 1x 60mm screw. **IMPORTANT ENSURE GABLE IS AT 90°.** Repeat for all roof bearers.



4. Drill/screw roof bearers at ridge together using 4x 60 mm screws.



### G - Fit Roof Panels

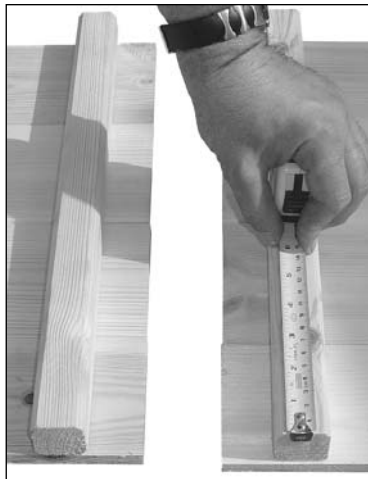

- 1 If applicable, place small roof panels at the back of the building. Place roof sections 'H' in pairs. The side where the boarding extends past the framework is to go at the ridge. Take 2 roof panels. On the framework to go at the ridge measure and mark at 46 mm of both panels from ONE end the mark is therefore mirrored.

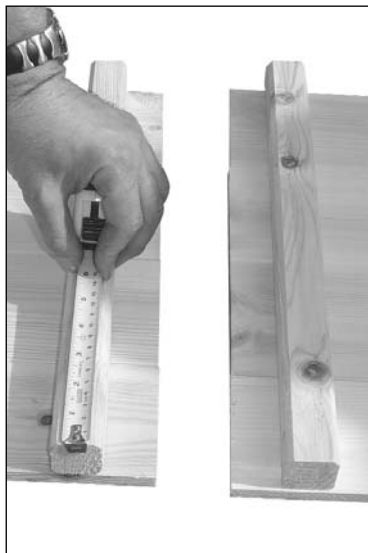

- 2 Cut out the framework at this measurement of both panels. Remove the nails.

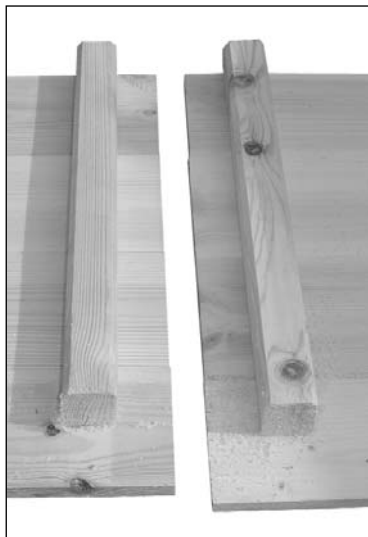

- 3 Place both panels on the walls at the back, flush and even with the back wall - the cutout at the back.



- 4 Secure to the back gable using 3x 40 mm nails into each gable.
- 5 Inside, drill/screw at ridge through frame of roof panel into roof bearer. Secure using 2x 60 mm screw for each roof panel.



- 6 Nail from outside into the roof bearers using 3x 40 mm nails for each roof panel/bearer.



- 7 Nail through roof boarding into side wall using 3x 40 mm nails per roof panel.

- 8 Repeat for all roof panels, except front ones.



- 9 Place both front roof panels in position. Mark where the roof frame meets the gable on the inside and outside.



- 10 Cut the framework at this measurement and remove. Repeat. Remove any nails.



- 11 Between the framework of the roof at the ridge, fit centre board using 4x 50 mm screws, 2 in each side.

- 12 Screw the front roof panels to the front wall using 3x 25 mm screws in each side. Nail roof panels to centre roof beam and side wall using 3x 40 mm nail in each position.

## H - Fit Hardware to Doors

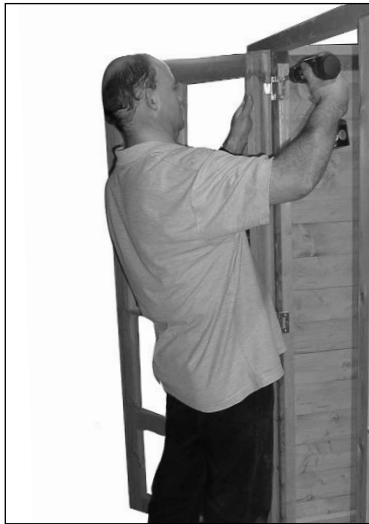

1 Open doors and secure hinges using remaining 4 x 25mm screws on each hinge.

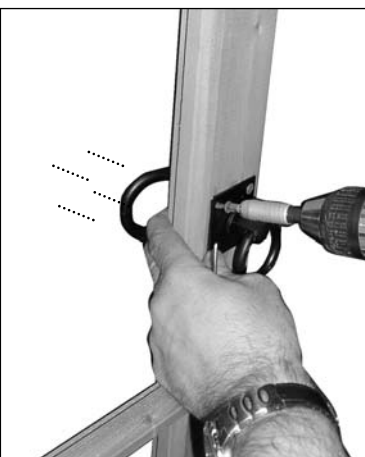

2 Position the handle with the gate latch against the door from the outside of the building. Check that the handle is located centrally, mark and drill a hole. Push the metal bar through the hole. Attach the gate latch handle on the outside and the ring handle on the inside. Secure both in position using 4 x 25mm black screws per handle.



3 Place the lever rest on door 'G2' in position – the gate latch should be horizontal. Screw into position using 2 x 25mm black screws.

## I - Felt Roof



1 Two rolls of felt 'J' have been supplied. Lay out the largest roll and cut in half length ways..

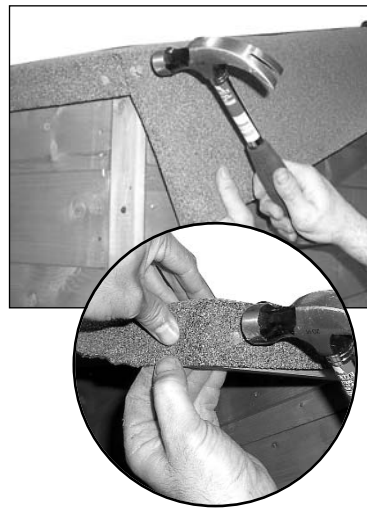

2 Starting at the lower edge (the eaves) place one 1 mtr wide piece from the front to the back of the building. An overhang of approximately 45mm should be allowed on each of the 3 sides although the felt will overhang at the back by more than this. Secure the felt using felt nails spaced at 100mm intervals. Repeat, but do not nail along the centre of the building until the piece of felt covering the ridge is in place.

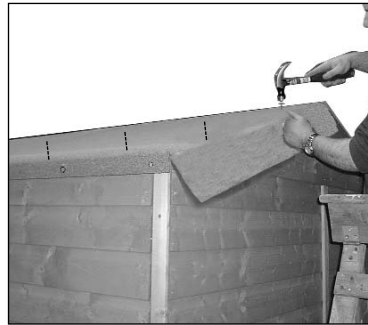

3 Place the smallest piece of felt at the peak (ridge) of the building. This piece will overlap both of the other pieces of felt. Nail into position along both edges of this piece and at both ends.

## J - Secure Walls to Floor



1 Screw all side panels to the floor on the inside of the building using 1x 60mm screw per separate panel and 1x 80mm screws into each of the two panels 'B1' either side of the doors.

## K - Fit Coverstrips

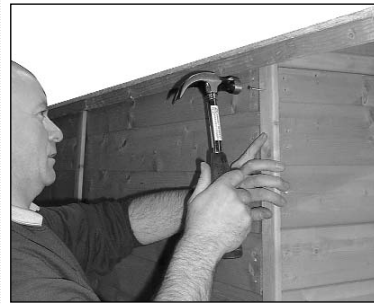

1 Cover strips 'I' are nailed over the joints between all side panels and at each corner. Secure in place using 4x 40mm nails per strip.

## L - Fascias & Diamond Assembly

1 Fit 2 plain fascia boards 'K' to the front of either side of the roof. Fit 2 more fascias at the back. Secure using 3x 40mm nails per piece.



2 Carefully trim off excess felt with cutting knife against the edge of the fascia board.



3 Nail diamonds 'K1' on top of and in the centre of the fascia board using 2x 40mm nails per diamond.

## M - Fit Glazing Material

1 Place glazing material 'L' into the aperture of each window.  
2 Hold into position with four pieces of beading 'L1'. The beading may need to be swapped around to get the best fit. When satisfied secure into position using 2x 15mm panel pins per piece of beading. Repeat for all window and door apertures.



## Assembly Completion Checklist

1 Check and ensure that no raised grain or splinters are evident on timber components. Sand down any raised grain or splinters using fine grade sandpaper.

2 Check that all screw, nail and pin heads are properly tapped home and are not proud of the timber surface.

3 Check and ensure that no screws, nails or pins protrude through any panel.

4 Check and ensure that all parts are properly secured against reasonable force.

5 Do not apply decorative wood finish/treatments to wet or damp timber. Please observe the instructions of the wood finish/treatment manufacturer.