

*Aviemore*  
*Art.No. 7013202*

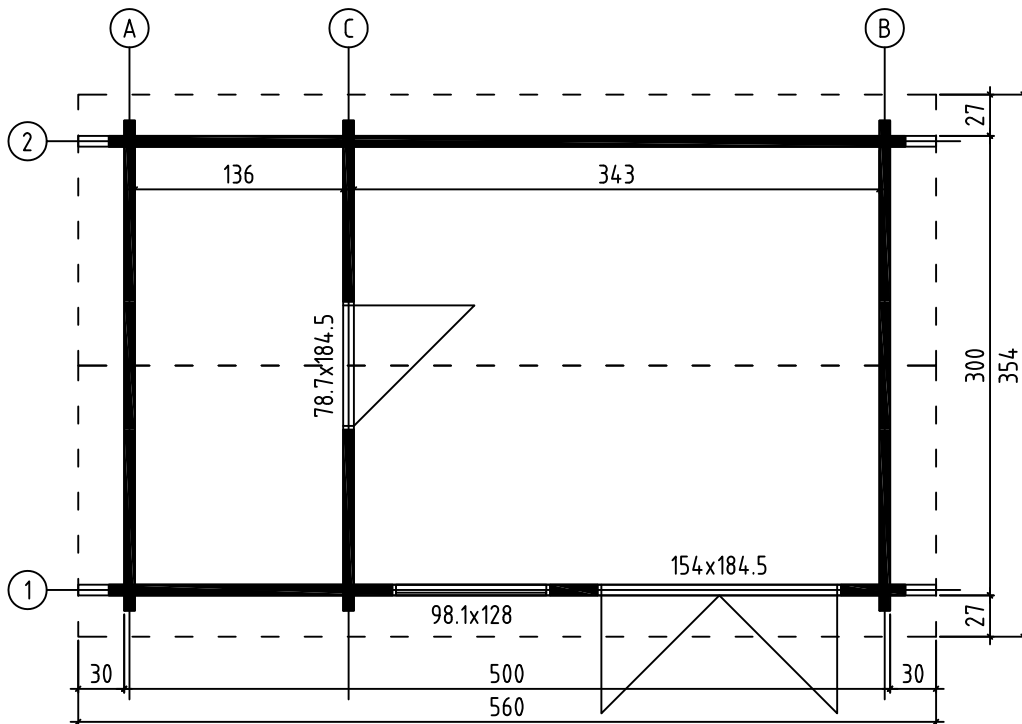

Avimore, Art.No.7013202  
GROUNDPLAN - GRUNDPLAN - PLAN DE MASSE



Avimore, Art.No.7013202  
 FOUNDATION - FUNDAMENT - FONDATION

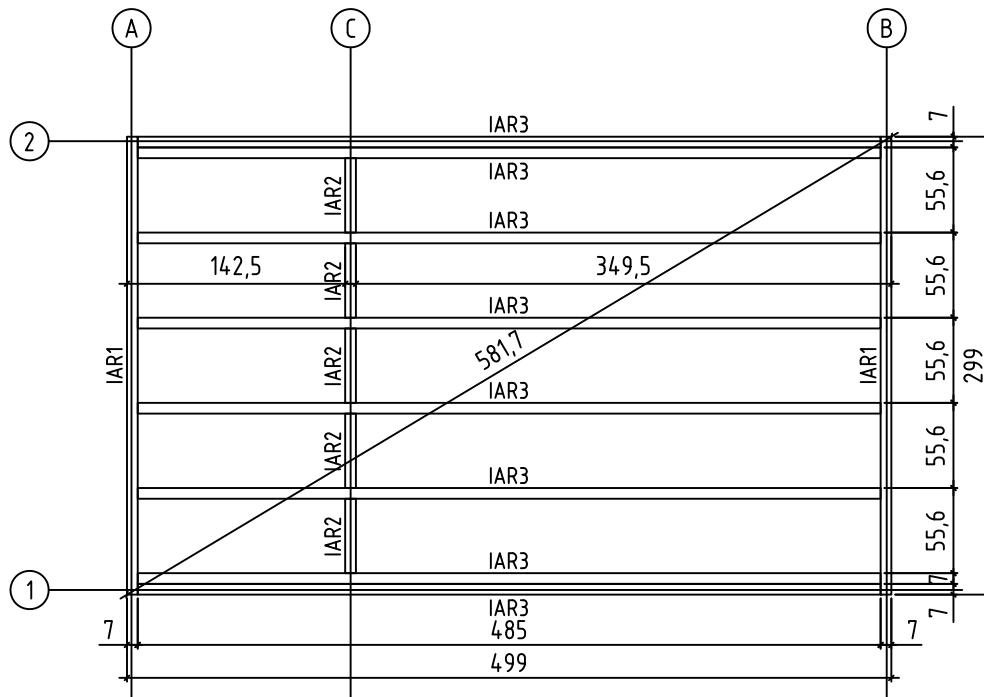

Avimore, Art.No.7013202  
FLOOR BOARDS - FUSSBODENBRETTER - PLAN POSE PLANCHER

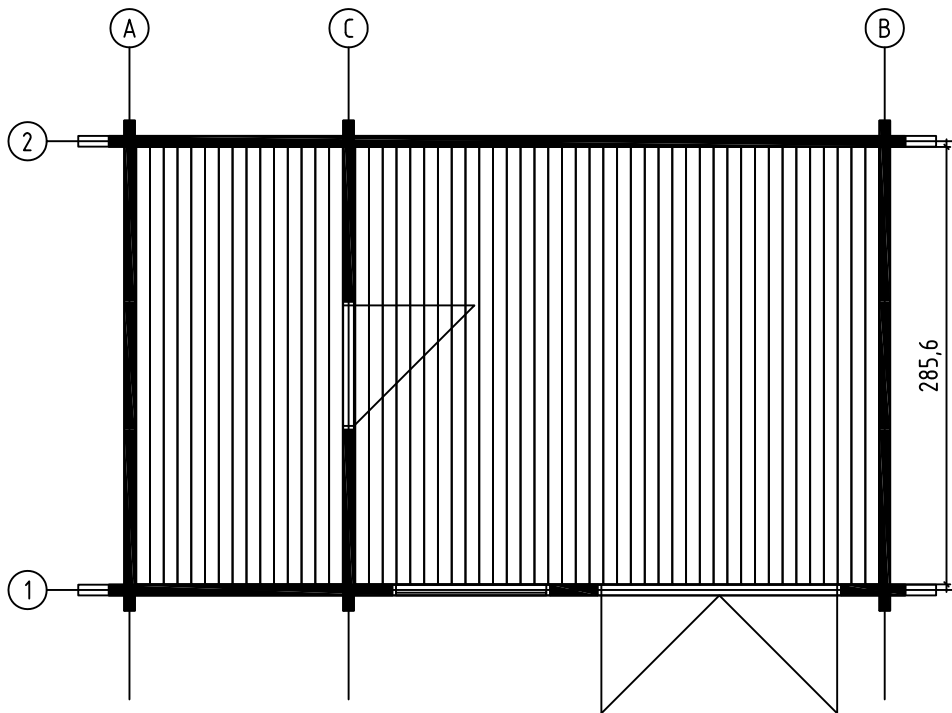

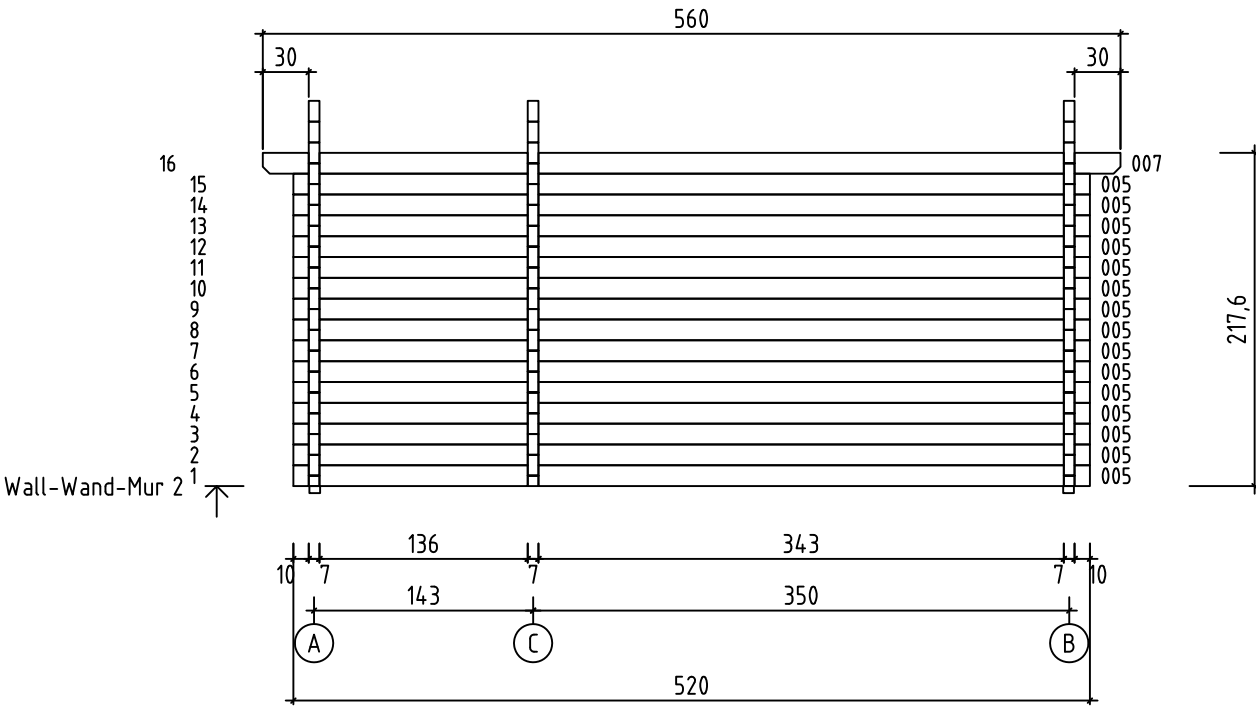
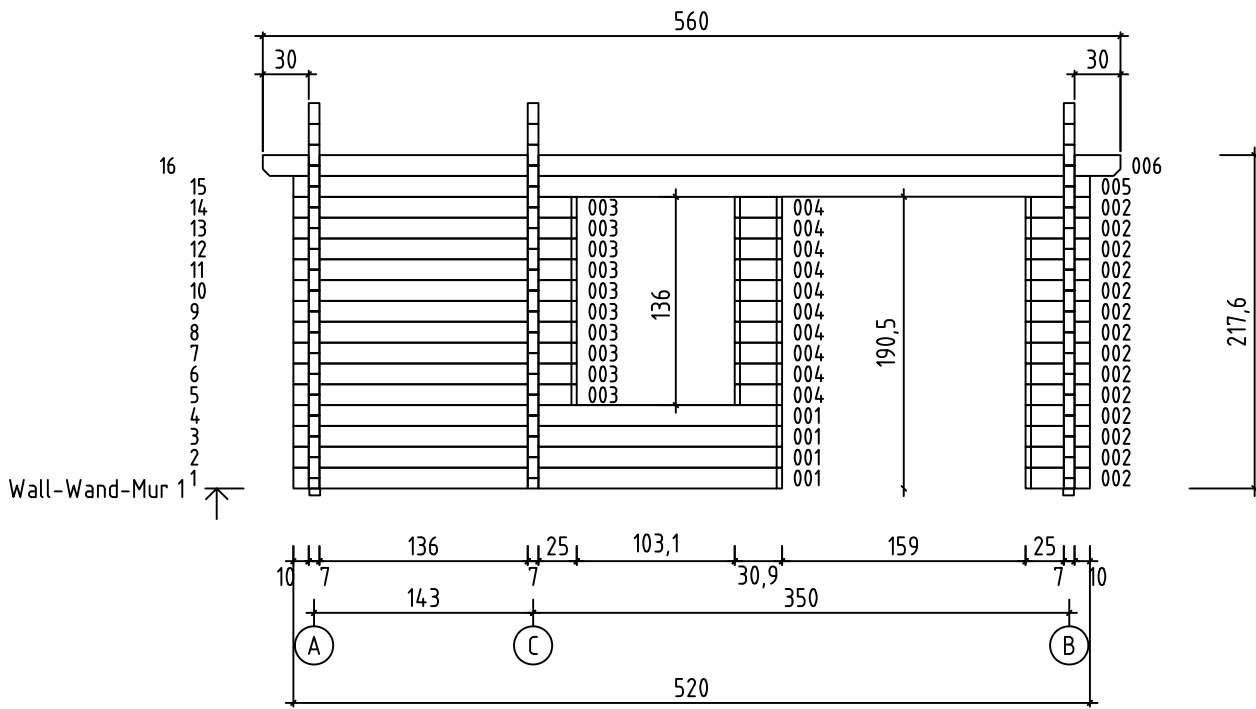

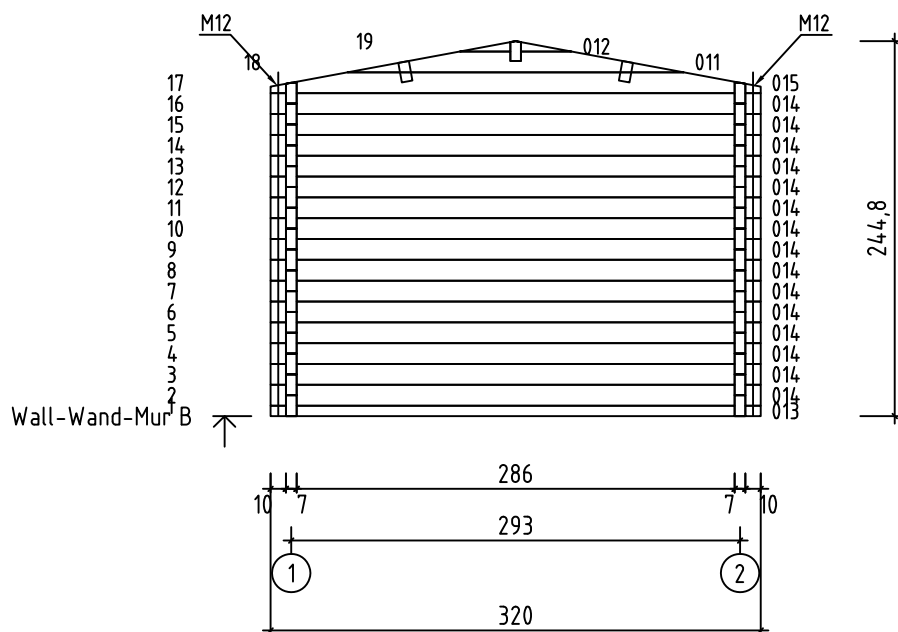
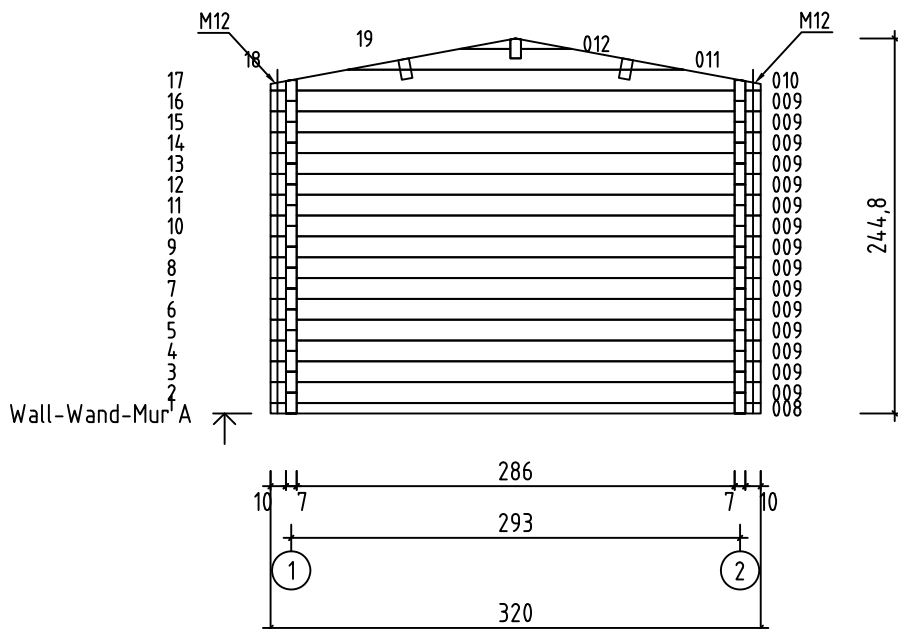

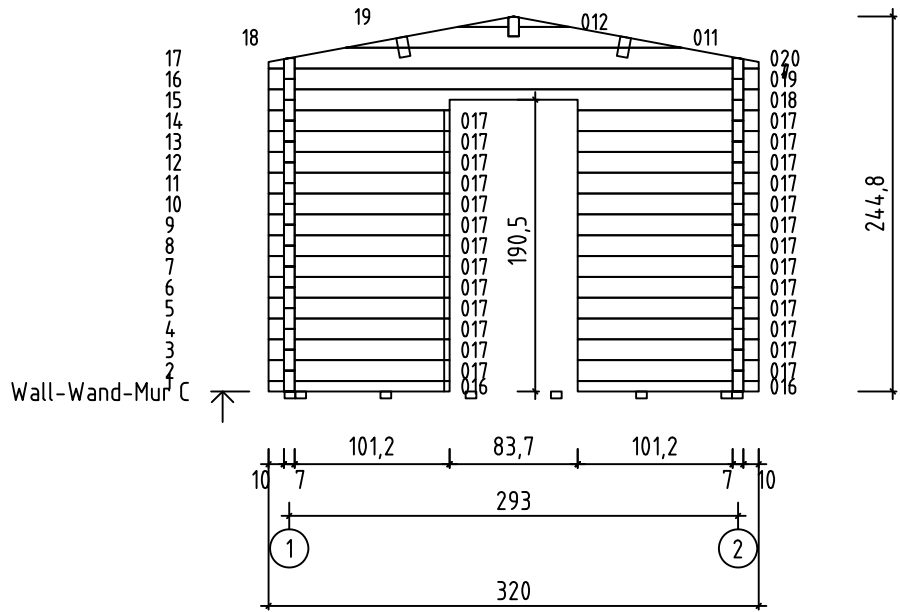

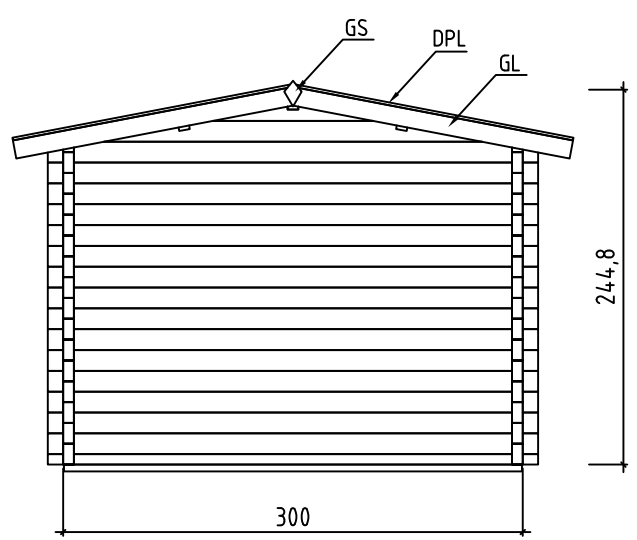
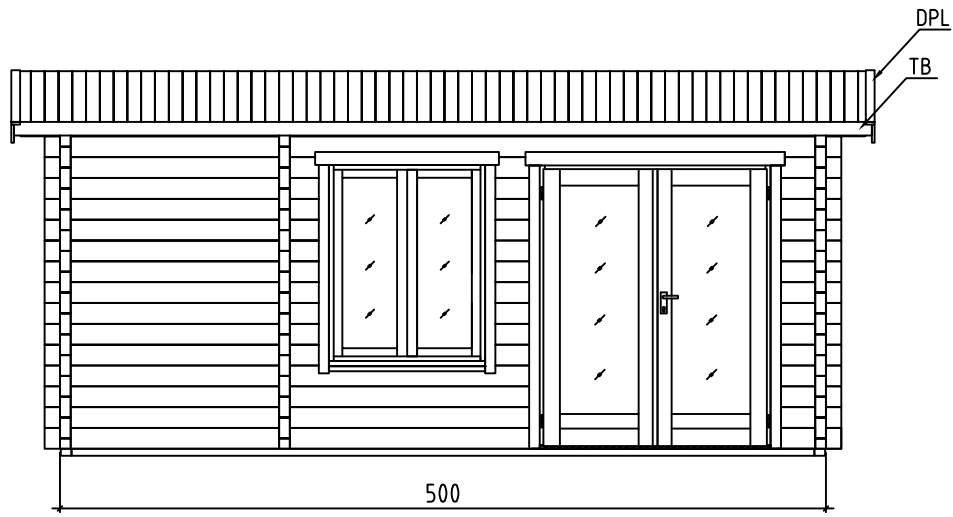



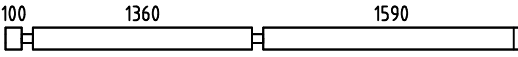

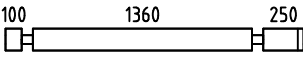

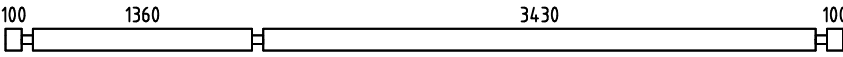
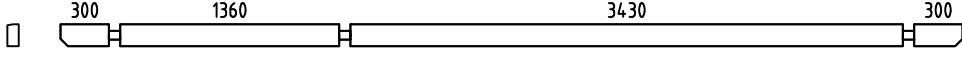
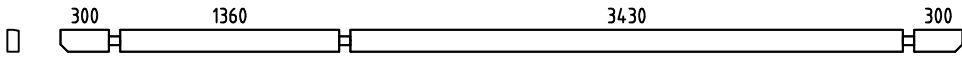
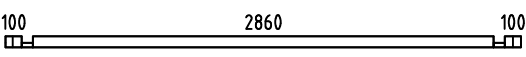
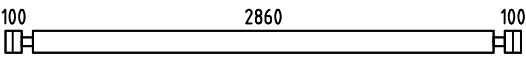
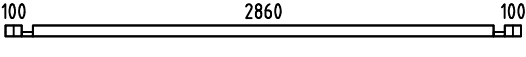
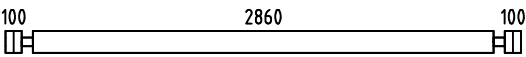
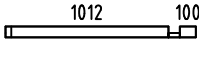
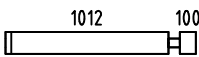
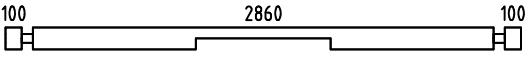
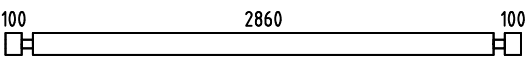
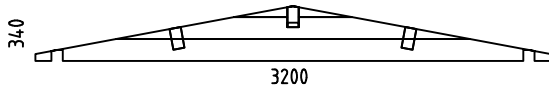
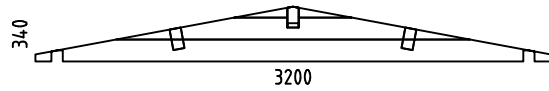
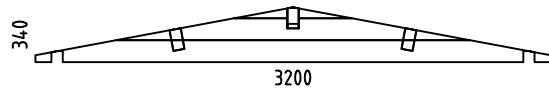
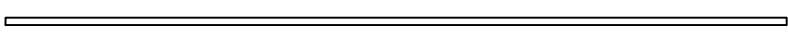
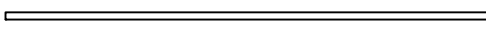

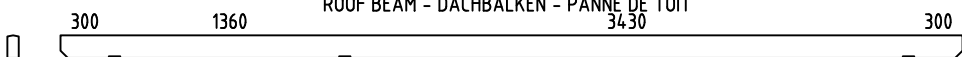
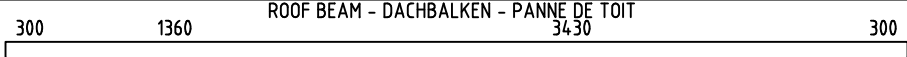







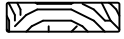

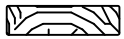
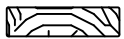
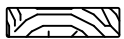
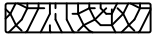



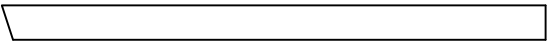
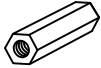





Pos	Avimmore, Art.No.7013202 Piece list - Stückliste - Liste des pieces	Q.	P (mm)	L (mm)
001		4	70x136	3190
002		14	70x136	420
003		10	70x136	1850
004		10	70x136	309
005		16	70x136	5200
006		1	70x136	5600
007		1	70x136	5600
008		1	70x68	3200
009		15	70x136	3200
013		1	70x68	3200
014		15	70x136	3200
016		2	70x68	1182
017		26	70x136	1182
018		1	70x136	3200
019		1	70x136	3200
WA-1		1		
WB-1		1		
WC-1		1		
IAR3	FOUNDATION - FUNDAMENT - FONDATION 	8	70x45	4850
IAR1	FOUNDATION - FUNDAMENT - FONDATION 	2	70x45	2990
IAR2	FOUNDATION - FUNDAMENT - FONDATION 	5	70x45	486
PR1	ROOF BEAM - DACHBALKEN - PANNE DE TOIT 	1	70x140	5600
A-PR1	ROOF BEAM - DACHBALKEN - PANNE DE TOIT 	2	70x140	5600
	FLOOR BOARDS - FUSSBODENBRETTER - LAME DE PLANCHER 	55	90x18	2856

Pos	Avimore, Art.No.7013202 Piece list - Stückliste - Liste des pieces	Q.	P (mm)	L (mm)
	ROOF BOARDS - DACHBRETTER - VOLIGES 	126	90x18	1800
	FLOOR FILLET-FUSSBODENLEISTE - CORNIERE DE FINITION DU PLANCHER 		15x40	21 m.
DPL	ROOFING FELT FILLET - DACHPAPPENLEISTE - BAGUETTE DE FIXATION DU FEUTRE BITUMEUX 	4	18x58	1850
M12	TREADED ROD M12 - GEWINDESTANGE M12 - TIGE FILETÉE M12 	4		190
M12	TREADED ROD M12 - GEWINDESTANGE M12 TIGE FILETÉE M12 	4		2000
LPL	FIXING FILLET - FIXIRUNGSLEISTE - PROFIL DE FIXATION 	1	20x70	787
LPL	FIXING FILLET - FIXIRUNGSLEISTE - PROFIL DE FIXATION 	2	20x70	981
LPL	FIXING FILLET - FIXIRUNGSLEISTE - PROFIL DE FIXATION 	2	20x70	1320
LPL	FIXING FILLET - FIXIRUNGSLEISTE - PROFIL DE FIXATION 	1	20x70	1540
LPL	FIXING FILLET - FIXIRUNGSLEISTE - PROFIL DE FIXATION 	4	20x70	1865
TB	EAVES BOARD - TRAUFBRETT - BANDEAU DE TOIT 	2	18x90	5600
DRV	ROOF EDGE REINFORCEMENT - DACHRANDVERSTÄRKUNG - CORNIERE DE RENFORT DE BORD DE TOIT 	4	28x34	2800
TBE6	FIXING FILLET FOR WINDOW - FIXIRUNGSLEISTE FÜR FENSTER - PROFIL DE FIXATION DES FENETRES 	2	28x34	1320
TBE6	FIXING FILLET FOR DOOR - FIXIRUNGSLEISTE FÜR TÜR - PROFIL DE FIXATION DES PORTES 	2	28x34	1768
TBE6	FIXING FILLET FOR DOOR - FIXIRUNGSLEISTE FÜR TÜR - PROFIL DE FIXATION DES PORTES 	2	28x34	1865
GL	GABLE MOULDING - GIEBELLEISTE PLANCHE DE RIVE 	4	18x120	1850
KL4	LENGTHENING BOLT FOR TREADED ROD - VERLÄNGERUNGSMUTTER FÜR GEWINDESTANGE - MANCHON DE RACCORDEMENT DE TIGE FILETÉE 	4		
KL1	DRIVE NUT TREADED ROD - EINSHLAGMUTTER FÜR GEWINDESTANGE - ÉCROU A FRAPPER POUR TIGE FILETÉE 	4		
KL2	NUT FOR TREADED ROD - MUTTER FÜR GEWINDESTANGE - ÉCROU POUR TIGE FILETÉE 	4		
KL3	PLAIN WASHER TREADED ROD - UNTERLEGSCHIEBE FÜR GEWINDESTANGE - RONDELLE PLATE POUR TIGE FILETÉE 	4		
HS12	SCREW FOR GABLE SEGMENT - SCHRAUBEN FÜR DECKBLATT - VIS POUR FIXATION LOSANGE DE FINITION 	4	3.5x35	
HS83	SCREW FOR FIXING FILLET - SCHRAUBEN FÜR FIXIRUNGSLEISTE - VIS POUR PROFIL DE FIXATION 	47	3.5x50	
HS84	SCREW FOR FIXING FILLET - SCHRAUBEN FÜR FIXIRUNGSLEISTE - VIS POUR PROFIL DE FIXATION 	28	3.5x50	
HS16	SCREW FOR GABLE MOULDING - SCHRAUBEN FÜR GIEBELLEISTE - VIS DE FIXATION POUR PLANCHE DE RIVE 	24	3.5x50	
HS32	SCREW FOR EAVES BOARDS - SCHRAUBEN FÜR TRAUFBRETTER - VIS DE FIXATION POUR BANDEAU DE TOIT 	24	4x40	

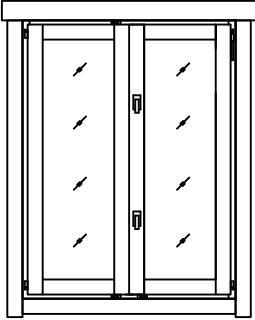
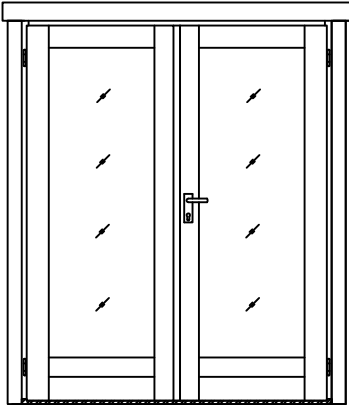
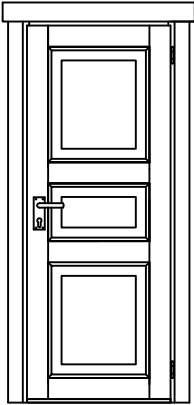

Pos	Avimore, Art.No.7013202 Piece list - Stückliste - Liste des pieces	Q.	P (mm)	L (mm)
2+	WINDOW-FENSTER-FENETRE 1021x1320 	1		
2+ TU .10P.c	DOOR-TÜR-PORTE 1580x1865 	1		
U.3TP.c	DOOR-TÜR-PORTE 827x1865 	1		

