

Name	Rusholme 400x500_44		
Zeichnung/Drawing	3D		
Profil/Profile	4.4x13.5	Datum/Date	27.02.2023

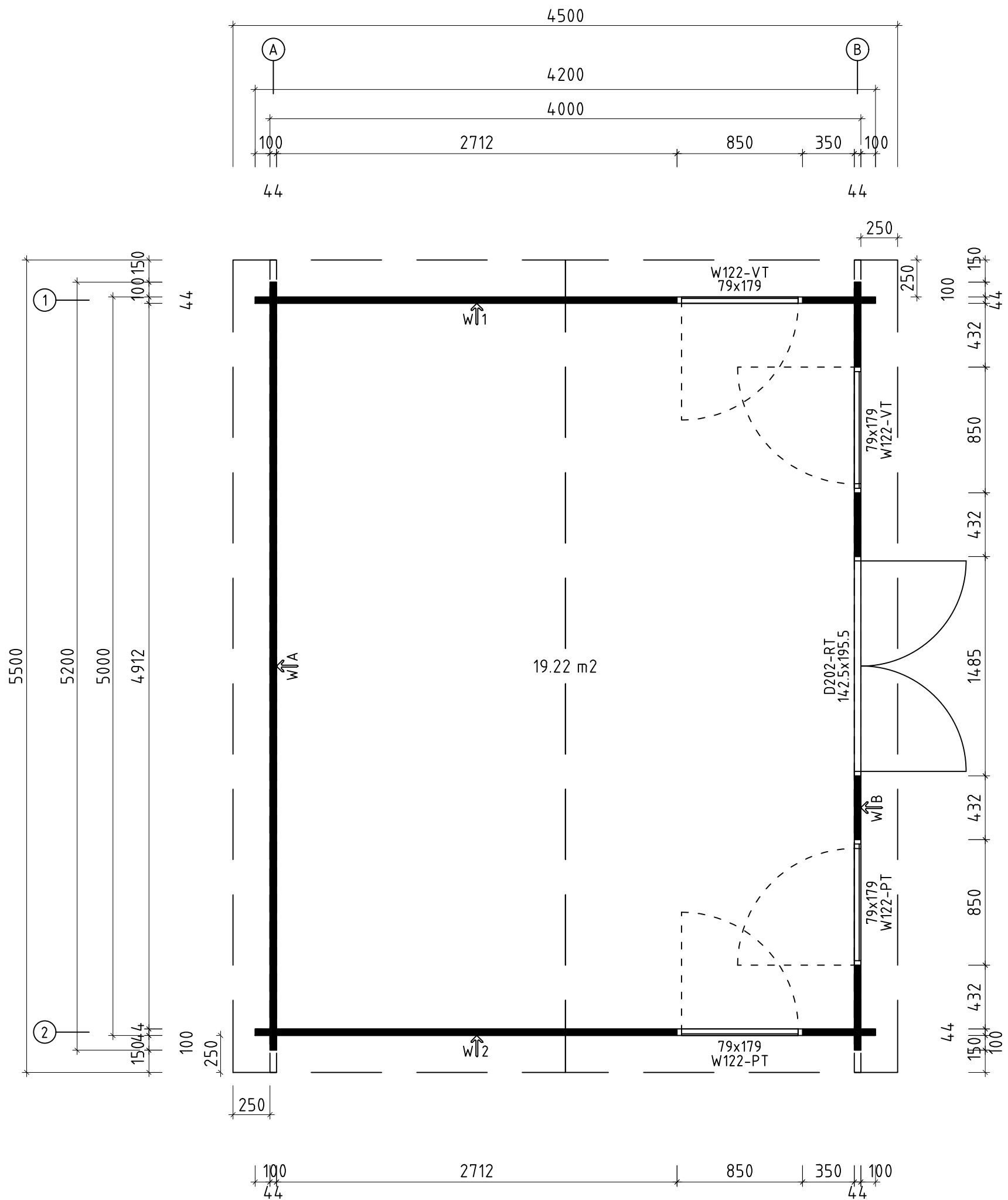







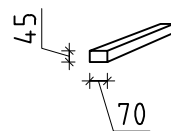
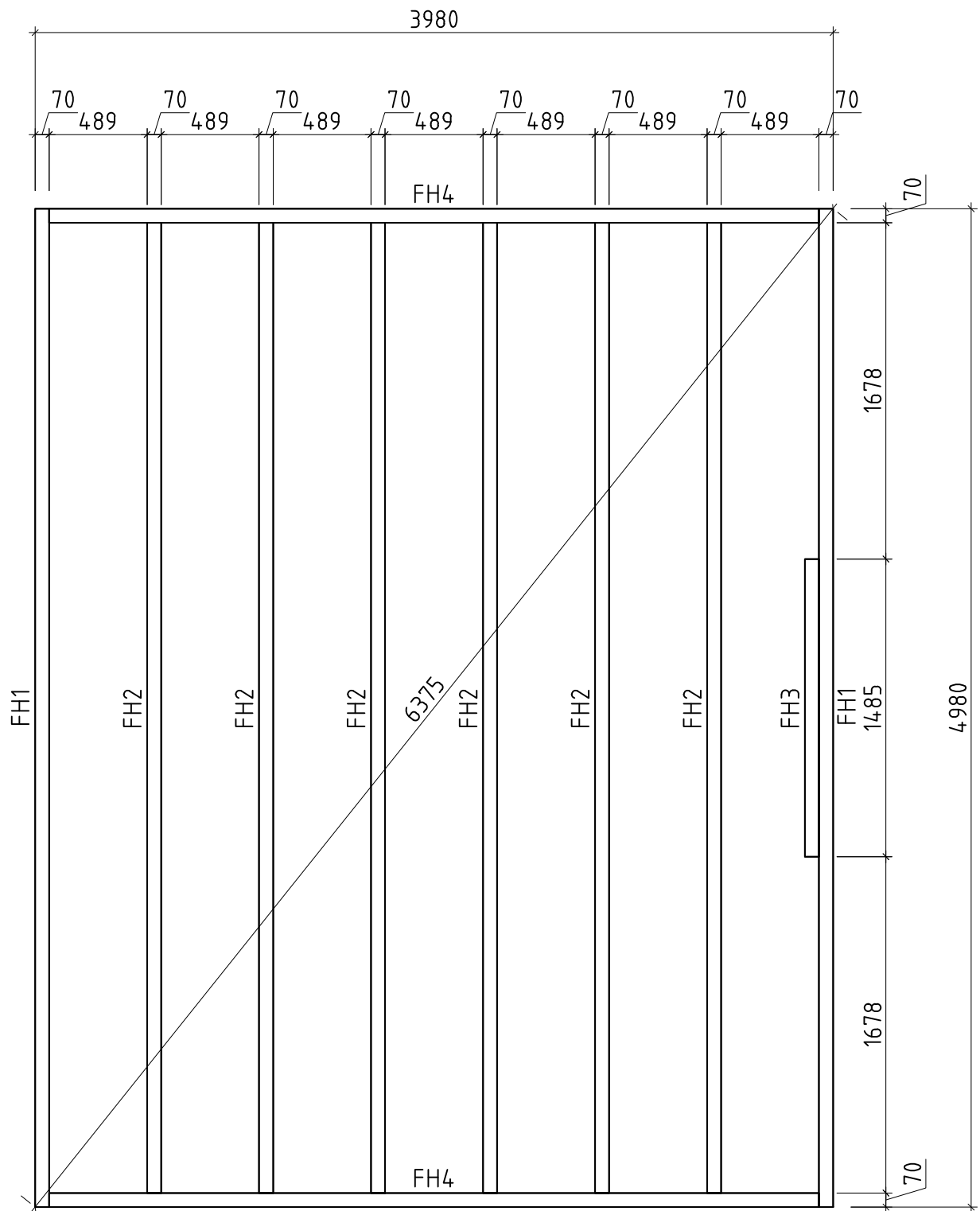

* Fenster und Türen sind ohne Sprossen
 Windows and doors are without muntins

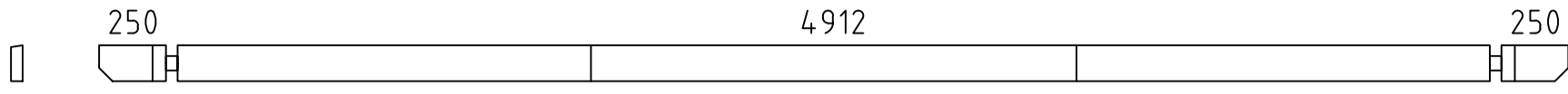
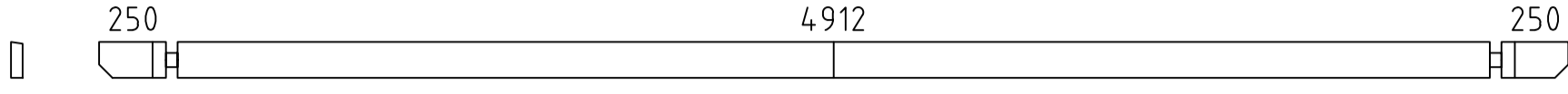
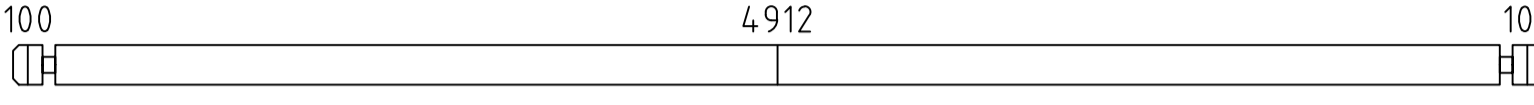
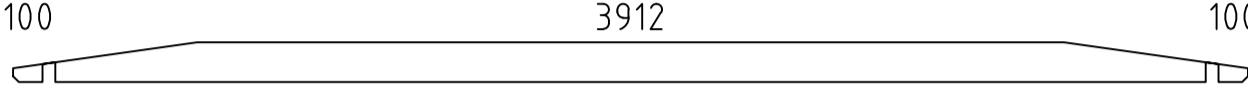
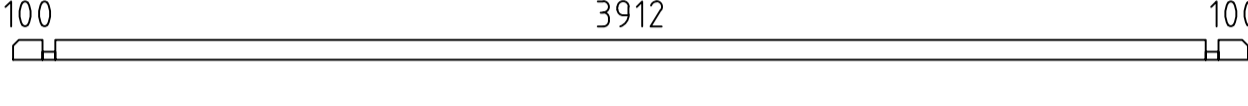
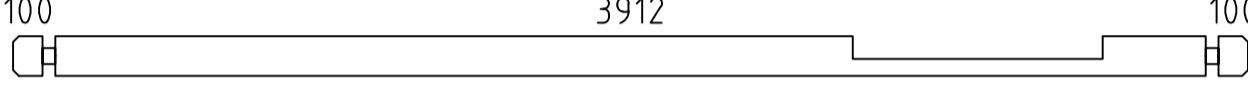
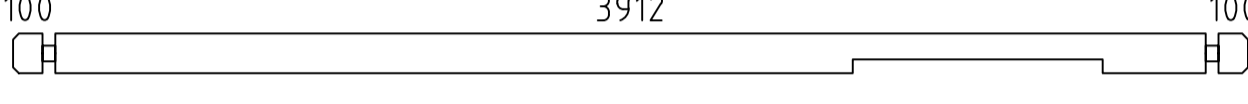
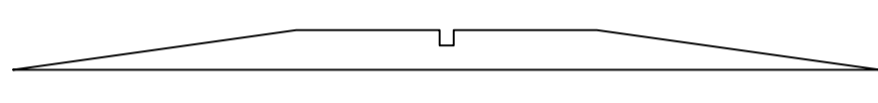
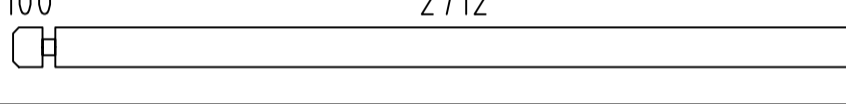
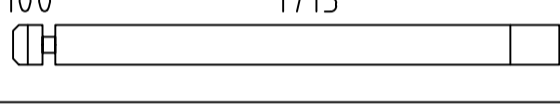
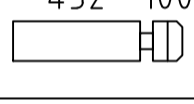
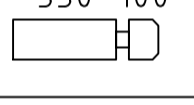

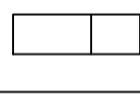
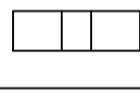
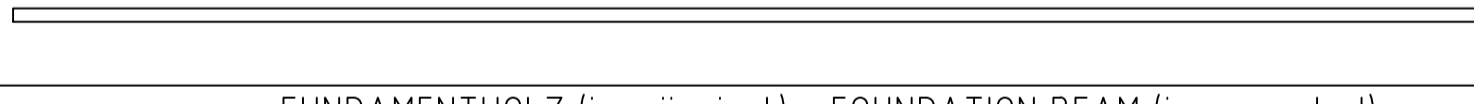
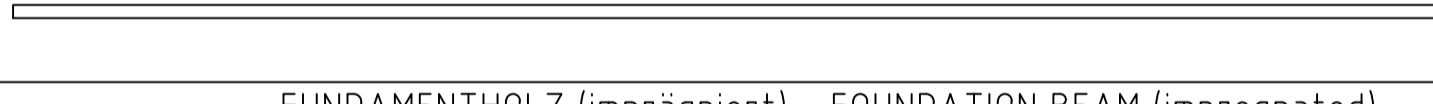
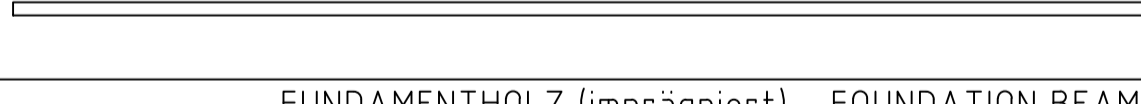

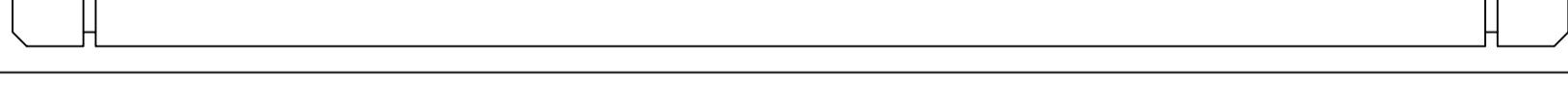

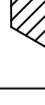

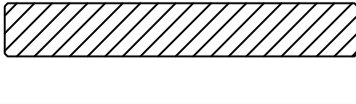
Q4 - Qualitätsklasse für Fenster und Türen/
 Quality class for windows and doors

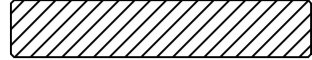
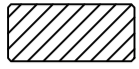
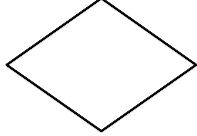
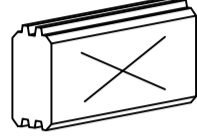
Name	Rusholme 400x500_44	
Zeichnung/Drawing	Grundplan_Plan	
Profil/Profile	4.4x13.5	Datum/Date 27.02.2023

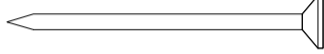
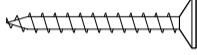
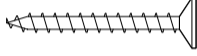
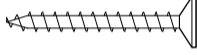
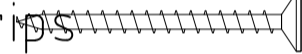
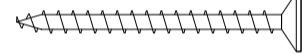
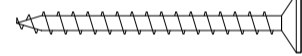
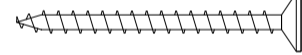
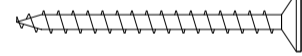
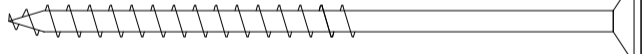

Name	Rusholme 400x500_44		
Zeichnung/Drawing	Lagerholzplan_Foundation beams		
Profil/Profile	4.4x13.5	Datum/Date	27.02.2023

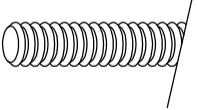
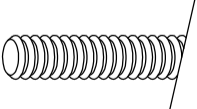
Pos	Teileliste/Specification Rusholme 400x500_44	Stck Pcs.	Profil Profile (mm)	Länge Length (mm)
	<u>Achtung!</u> Die Giebelbohlen können teilweise schon vormontiert sein! Bitte beachten - diese erscheinen nicht ganz so wie in der Teileliste beschrieben.			
	<u>Notice!</u> The gable pieces can be partly pre-assembled! Please notice - those differ from the description given in the specification list.			
001		1	44x135	5500
002		1	44x135	5500
003		15	44x135	5200
004		2	44x135	4200
005		2	44x68	4200
006		2	44x135	4200
007		2	44x135	4200
008		2	44x135	2949
009		26	44x135	2856
010		2	44x135	1858
011		28	44x135	576
012		26	44x135	494
013		4	44x68	487
014		20	44x135	432
015		8	44x135	432
FH1	FUNDAMENTHOLZ (imprägniert) - FOUNDATION BEAM (impregnated) 	2	70x45	4980
FH2	FUNDAMENTHOLZ (imprägniert) - FOUNDATION BEAM (impregnated) 	6	70x45	4840
FH4	FUNDAMENTHOLZ (imprägniert) - FOUNDATION BEAM (impregnated) 	2	70x45	3840
FH3	FUNDAMENTHOLZ (imprägniert) - FOUNDATION BEAM (impregnated) 	1	70x45	1485
PF1	PFETTEN_PURLINS 	5	58x170	5500
	DACHBRETTER - ROOF BOARDS 	98+1	113x18	2272
	FUSSBODENBRETTER - FLOOR BOARDS 	44+1	113x18	3907
	DECKENLEISTEN - CEILING STRIPS  ✓		15x28	34.0 lfm/rm
	FUSSBODENLEISTEN - FLOOR STRIPS  ✓		18x40	19.0 lfm/rm
G02-1	GIEBELBRETTER - GABLE BOARDS 18x120  8° ✓	4	18x120	2352
Kood	Rusholme 400x500_44	Materjal		Leht 1/3

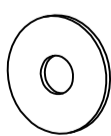
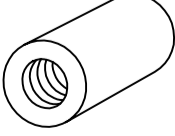
Pos	Teileliste/Specification Rusholme 400x500_44		Stck Pcs.	Profil Profile (mm)	Länge Length (mm)
G06-1	GIEBELDECKLEISTEN - GABLE COVER STRIPS 18x58	 ✓	4	18x58	2352
T01-1	TRAUFENBRETTER - EAVES BOARDS 18x95		2	18x95	5500
T06-1	TRAUFENLEISTEN - EAVES STRIPS 18x40	 ✓	4	18x40	11.5 lfm/rm
GS	GIEBELSEGMENT - GABLE DIAMOND		2		
SH	SCHLAGHÖLZER - MOUNTING PIECES		3		
NG2 550	NÄGEL - NAILS 2.5x50 Dachbretter - Roof boards		784		
NG2 550	NÄGEL - NAILS 2.5x50 Fussbodenbretter - Floor boards		704		
SR3 030	Schrauben - Screws 3.0x30 Deckenleisten - Ceiling strips		64		
SR3 030	Schrauben - Screws 3.0x30 Fussbodenleisten - Floor strips		36		
SR3 030	Schrauben - Screws 3.0x30 Traufenleisten - Eaves strips		24		
SR37	Schrauben - Screws 3.5x45 Tür/Fenster leisten - Door/Window strips		136		
SR3 545	Schrauben - Screws 3.5x45 Giebelbretter - Gable boards		24		
SR3 545	Schrauben - Screws 3.5x45 Giebeldeckleisten - Gable cover strips		24		
SR3 545	Schrauben - Screws 3.5x45 Giebelsegment - Gable diamond		4		
SR3 545	Schrauben - Screws 3.5x45 Traufenbretter - Eaves boards		24		
SR5 0100	Schrauben - Screws 5.0x100 Fundamenthölzer - Foundation beams		44		
ML1	Metallstange - Metal bar		1	D10	1170
ML2	Metallstange - Metal bar		5	D10	900
ML3	Metallstange - Metal bar		2	D10	770
KL1	Gewindestange - Threaded Rod M8		4		2000
KL2	Gewindestange - Threaded Rod M8		4		190
KV M UT M8	Mutter - Nut M8		8		
KV S EIB M8X25	U-Scheibe - Washer M8 Ø25		8		
KV MU TJ M8	Befestigungsmutter - Fixing nut M8		4		
Kood Rusholme 400x500_44			Materjal		Leht 2/3

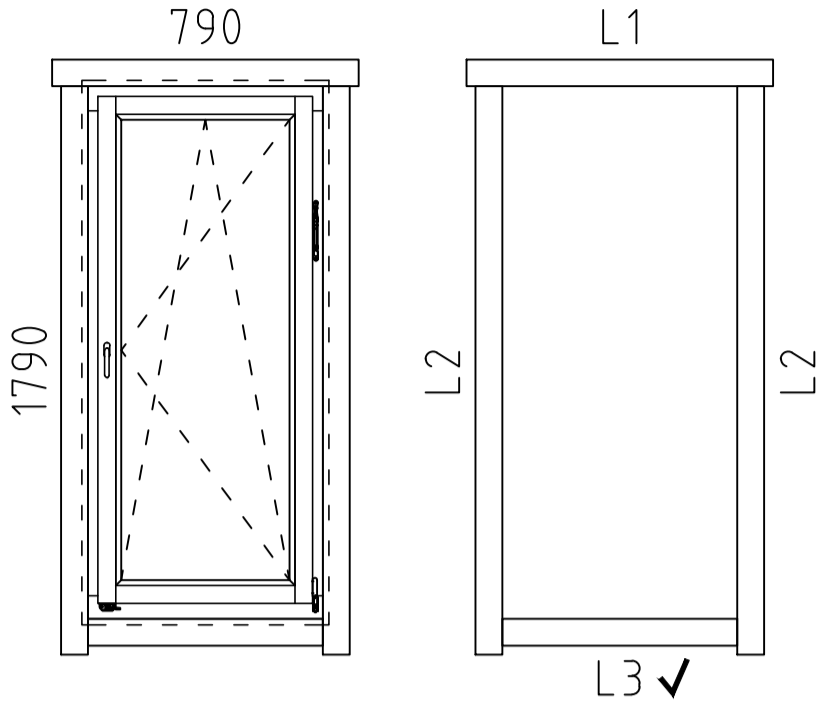
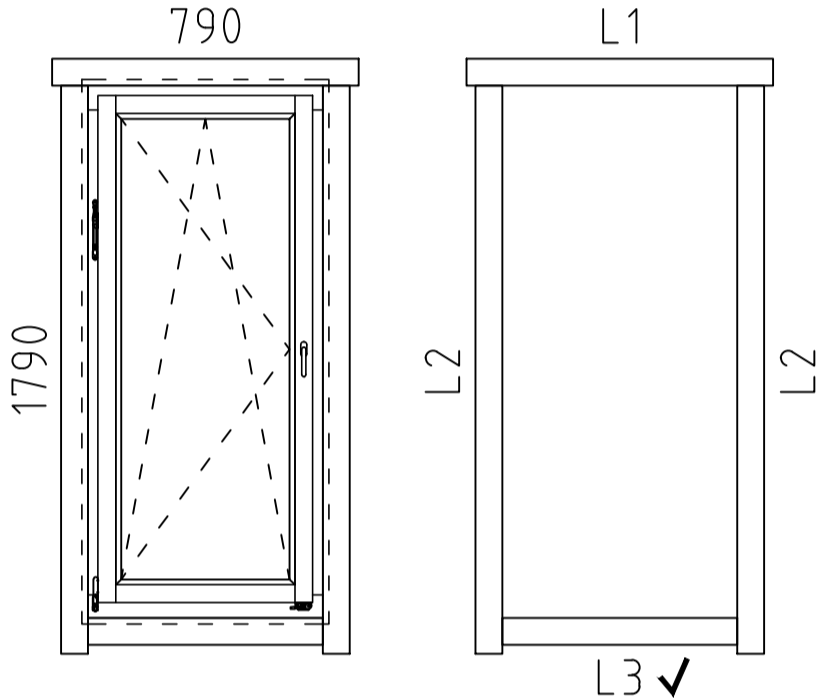
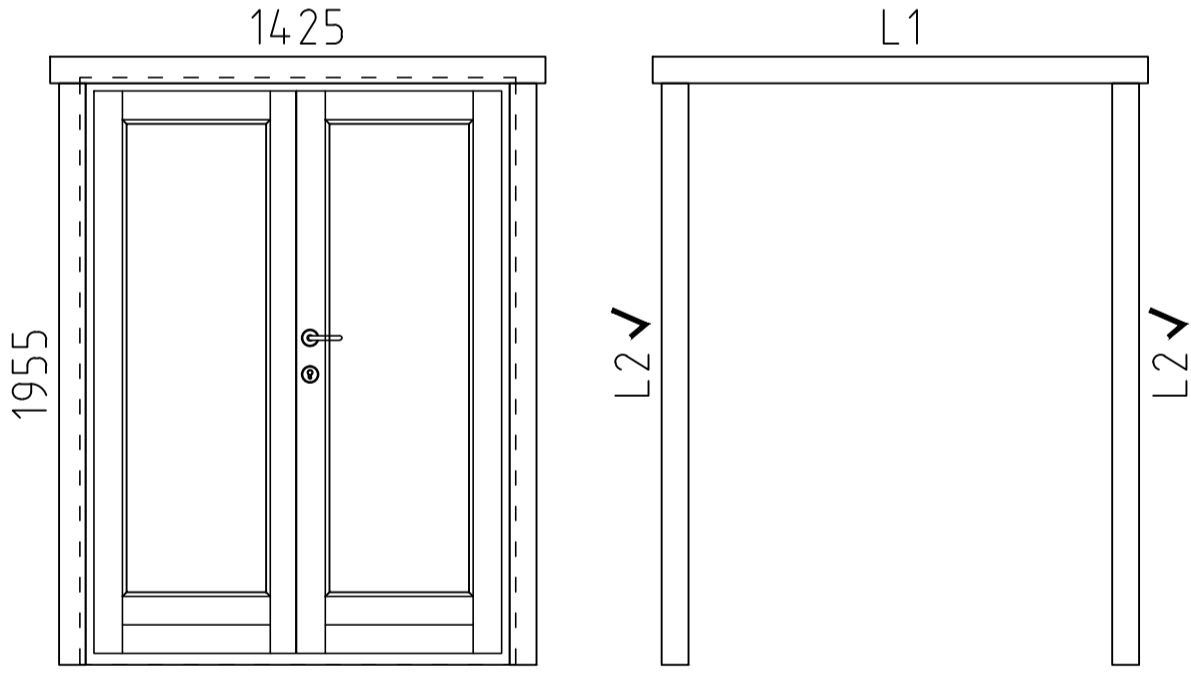
Pos	Teileliste/Specification Rusholme 400x500_44	Stck Pcs.	Profil Profile (mm)	Länge Length (mm)
	<p>FENSTER/WINDOW Q4 W4-S44P-0XT-07901790</p>  <p>W122-PT</p> <p>L1 18x90 L=1030mm 2x L2 18x90 L=1910mm 4x L3 18x90 L=790mm 2x ✓</p>	2		
	<p>FENSTER/WINDOW Q4 W4-S44V-0XT-07901790</p>  <p>W122-VT</p> <p>L1 18x90 L=1030mm 2x L2 18x90 L=1910mm 4x L3 18x90 L=790mm 2x ✓</p>	2		
	<p>TÜR/DOOR Q4 D4-D44R-0XT-14251955</p>  <p>D202-RT</p> <p>L1 18x90 L=1665mm 2x L2 18x90 L=1955mm 4x ✓</p> <p>DIN rechts / Right handed</p>	1		
	<p>✓ - Bitte selber anpassen (falls nötig)! / Cut into length on site (if needed)!</p>			

1

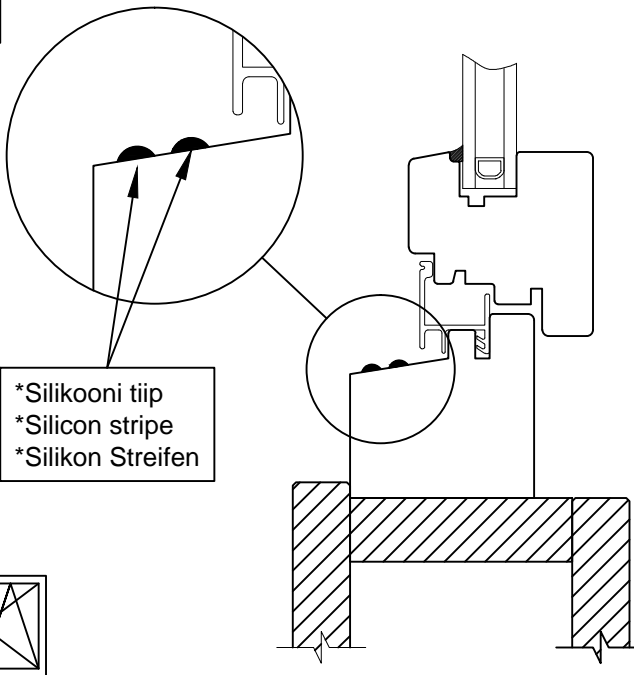

*Silikooni tiip
*Silicon stripe
*Silikon Streifen

2

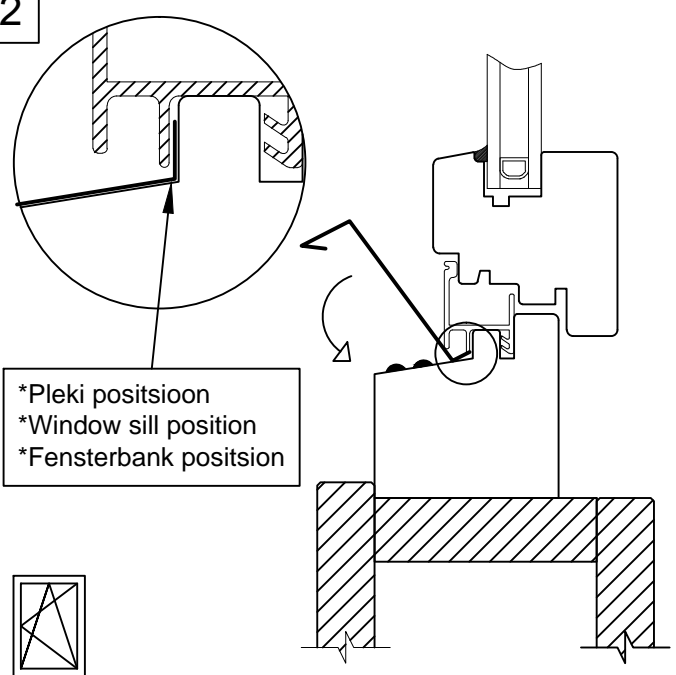

*Pleki positsioon
*Window sill position
*Fensterbank position

3

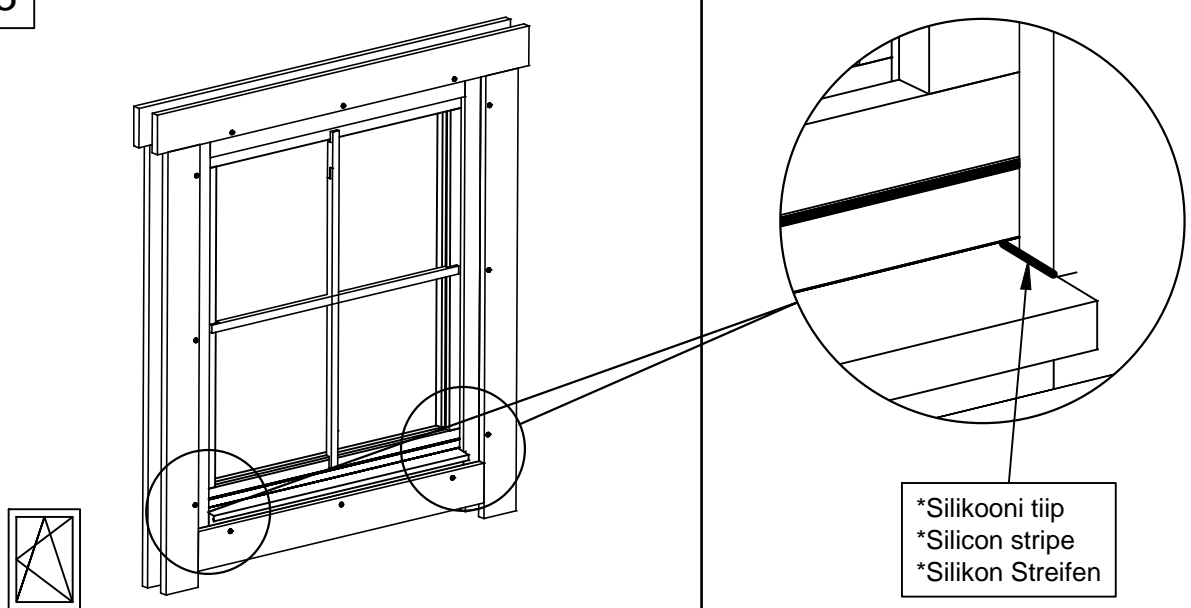

*Silikooni tiip
*Silicon stripe
*Silikon Streifen

1

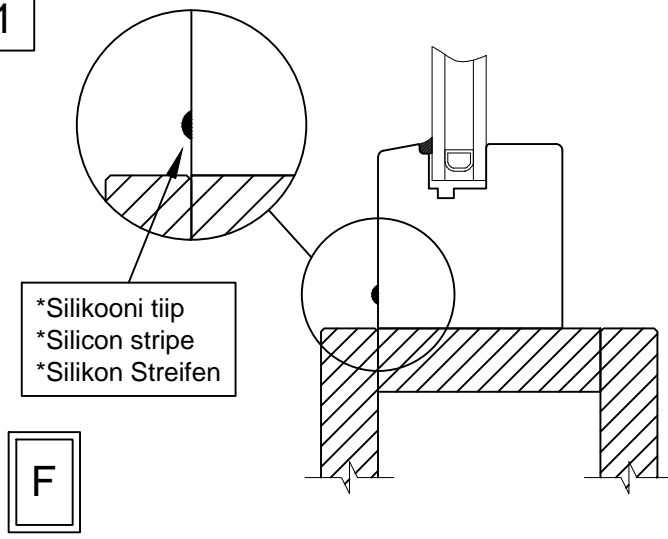

*Silikooni tiip
*Silicon stripe
*Silikon Streifen

2

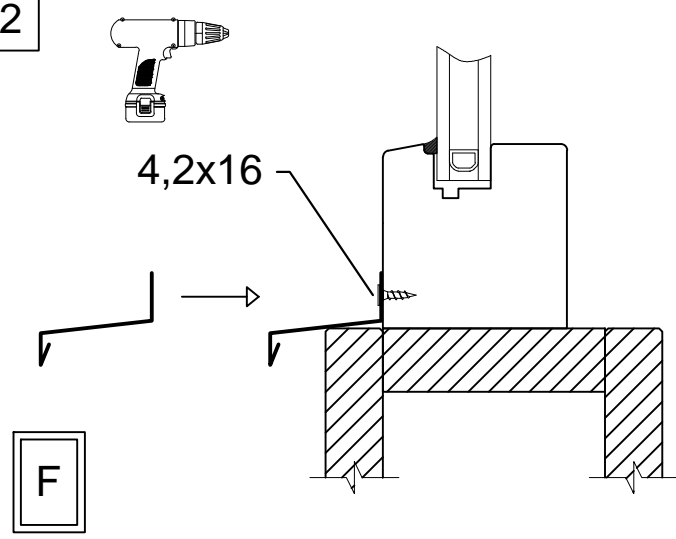

4,2x16

Aken	Q4-Q6	-	paigaldusjuhhis
Window	Q4-Q6	-	assembly instructions
Fenster	Q4-Q6	-	Montageanleitung

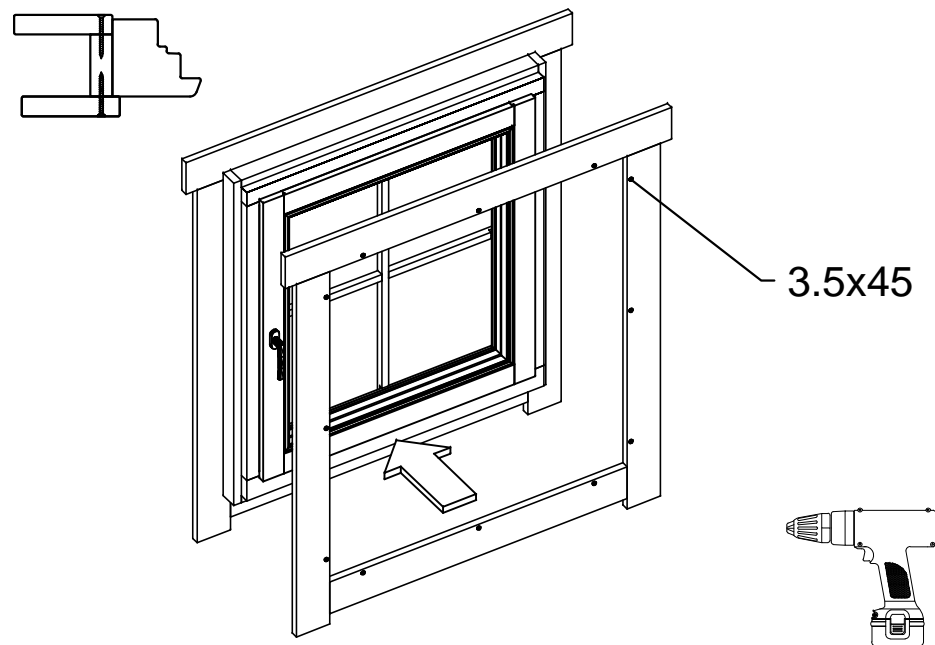
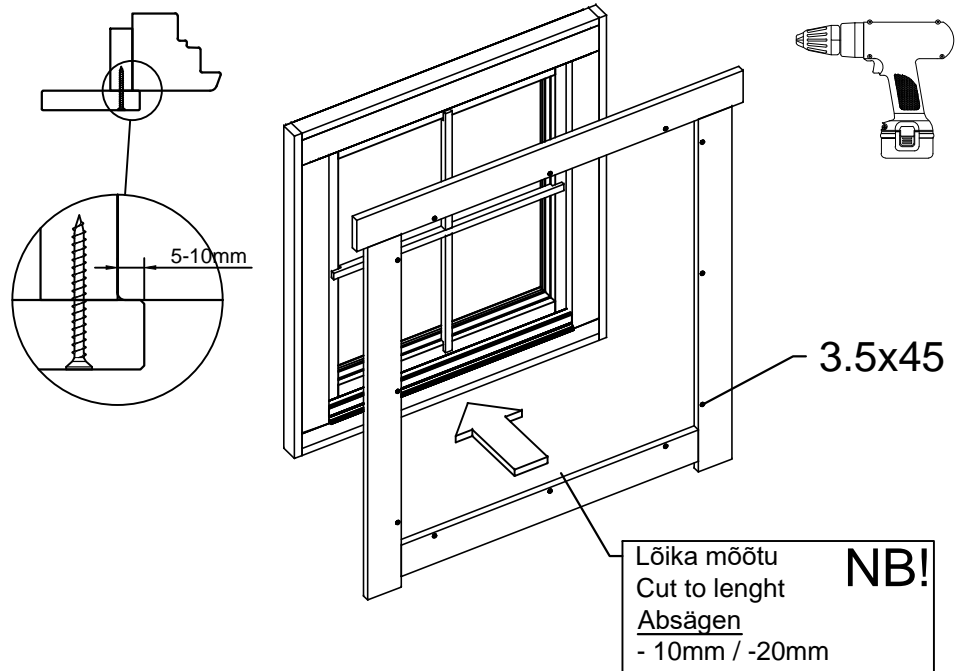
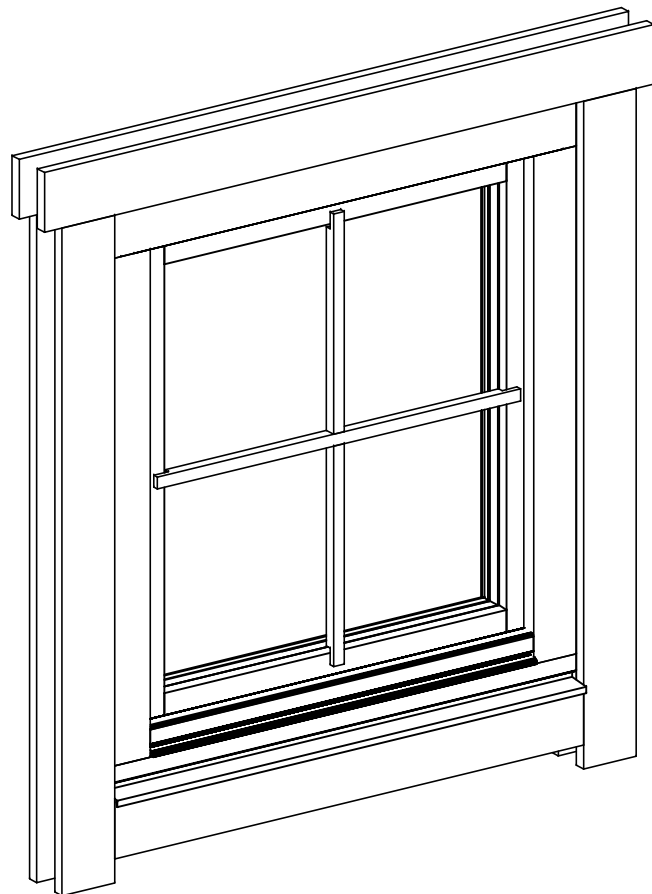

Ukse montaa 0 / Tür montage / Door assembly
(GH+ / SH)

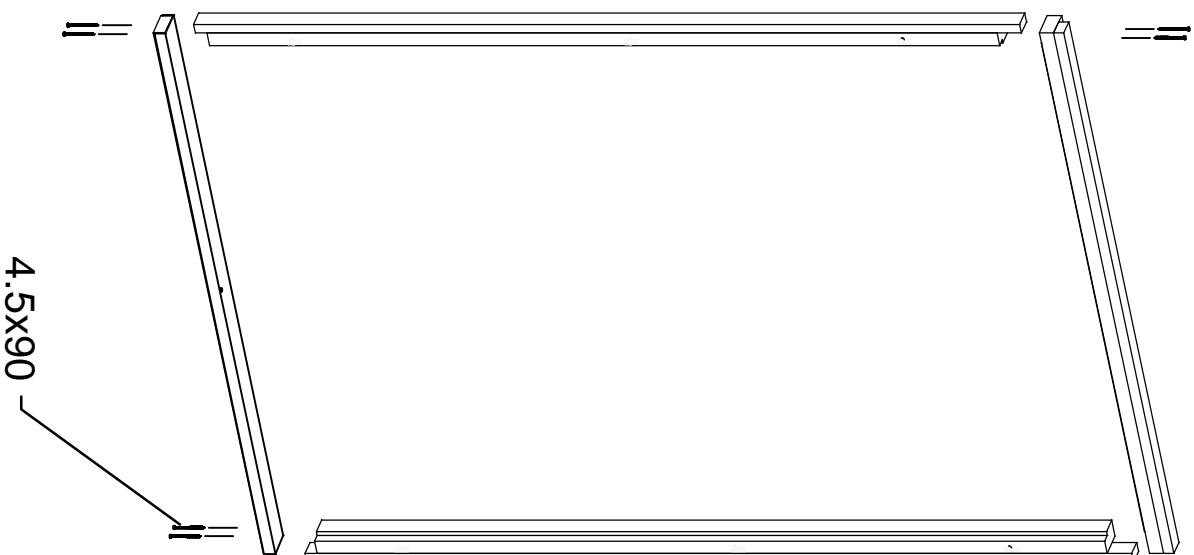
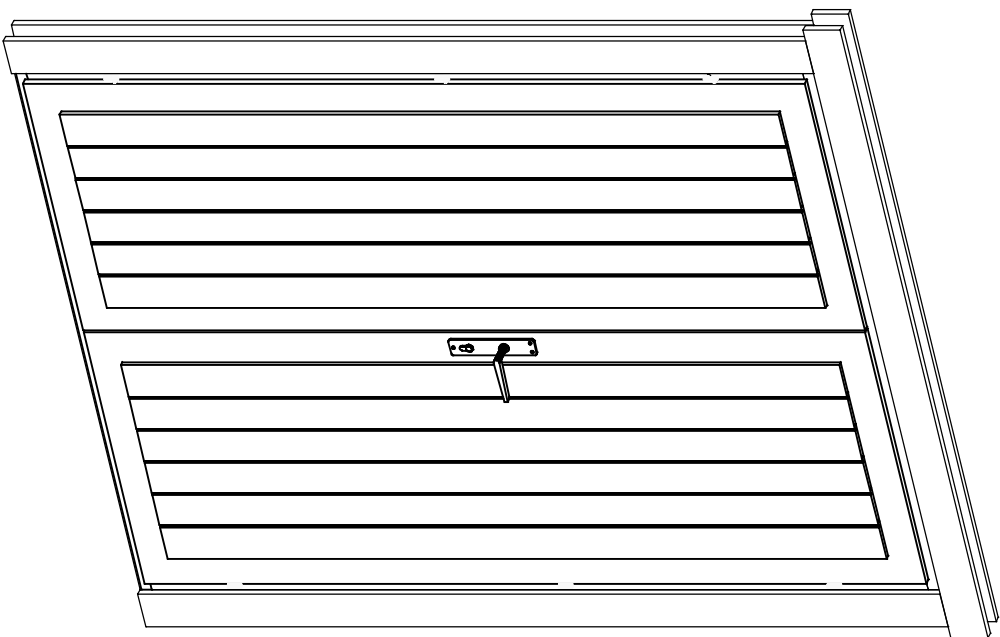

4.5x90

4.5x90

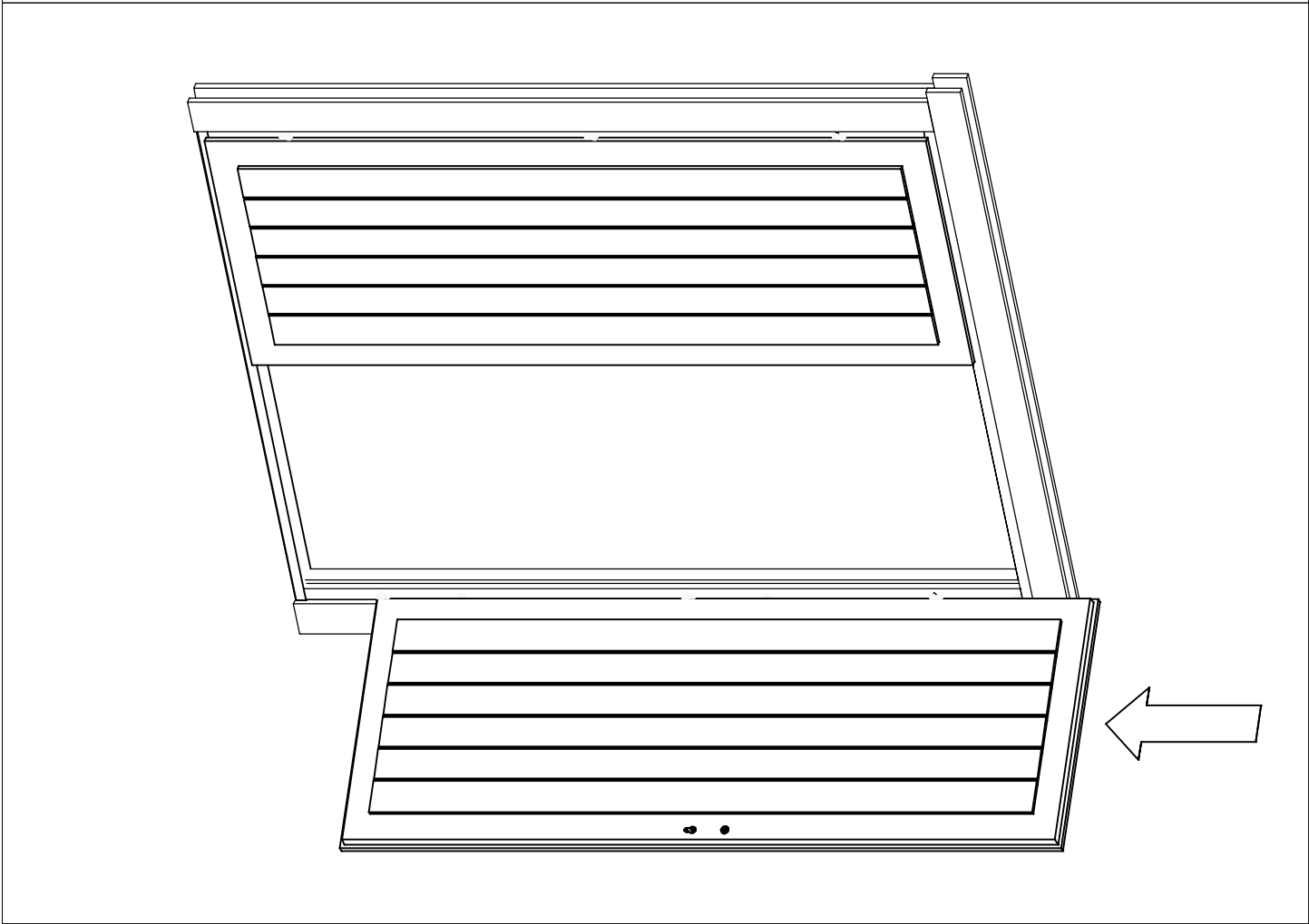
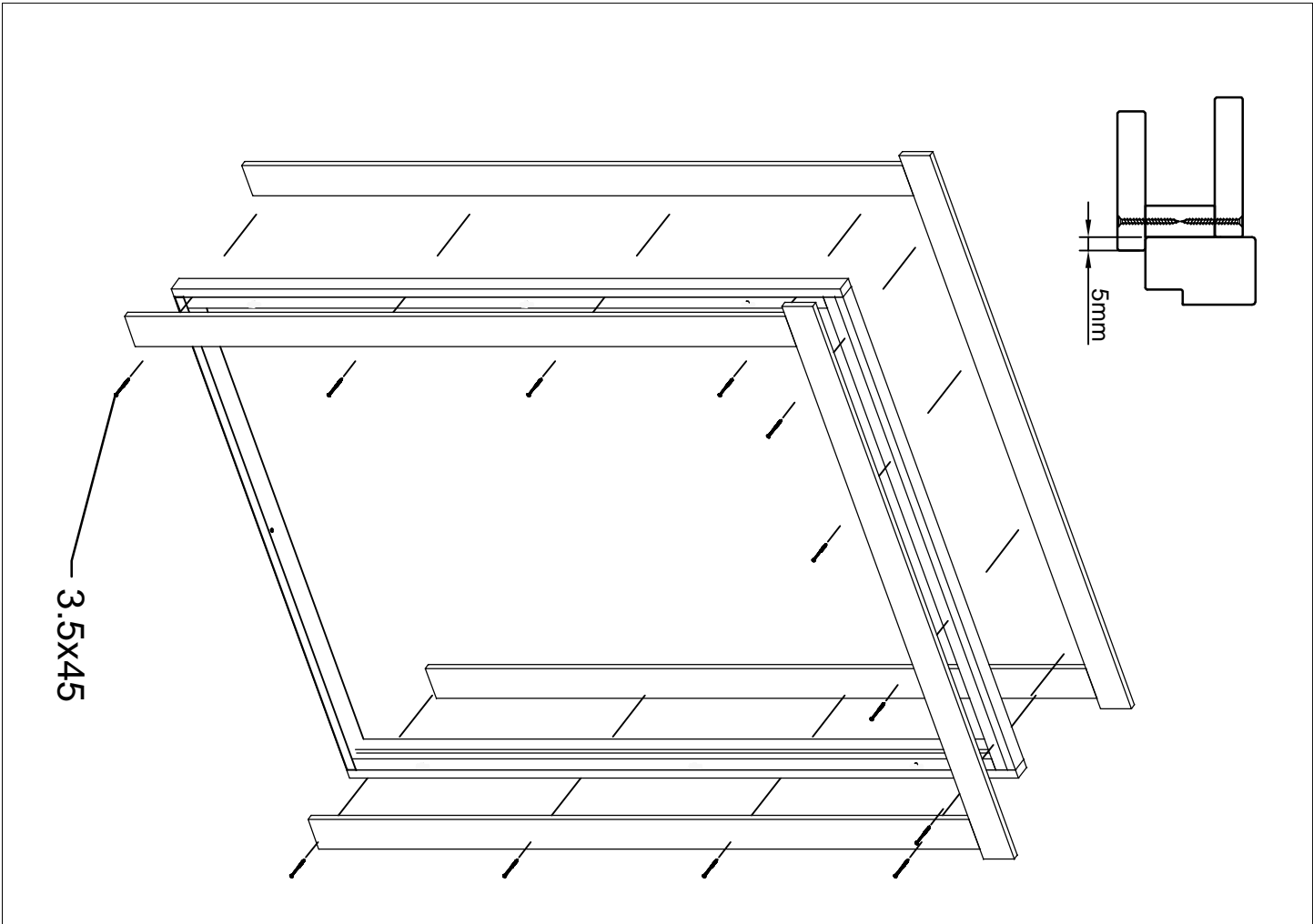

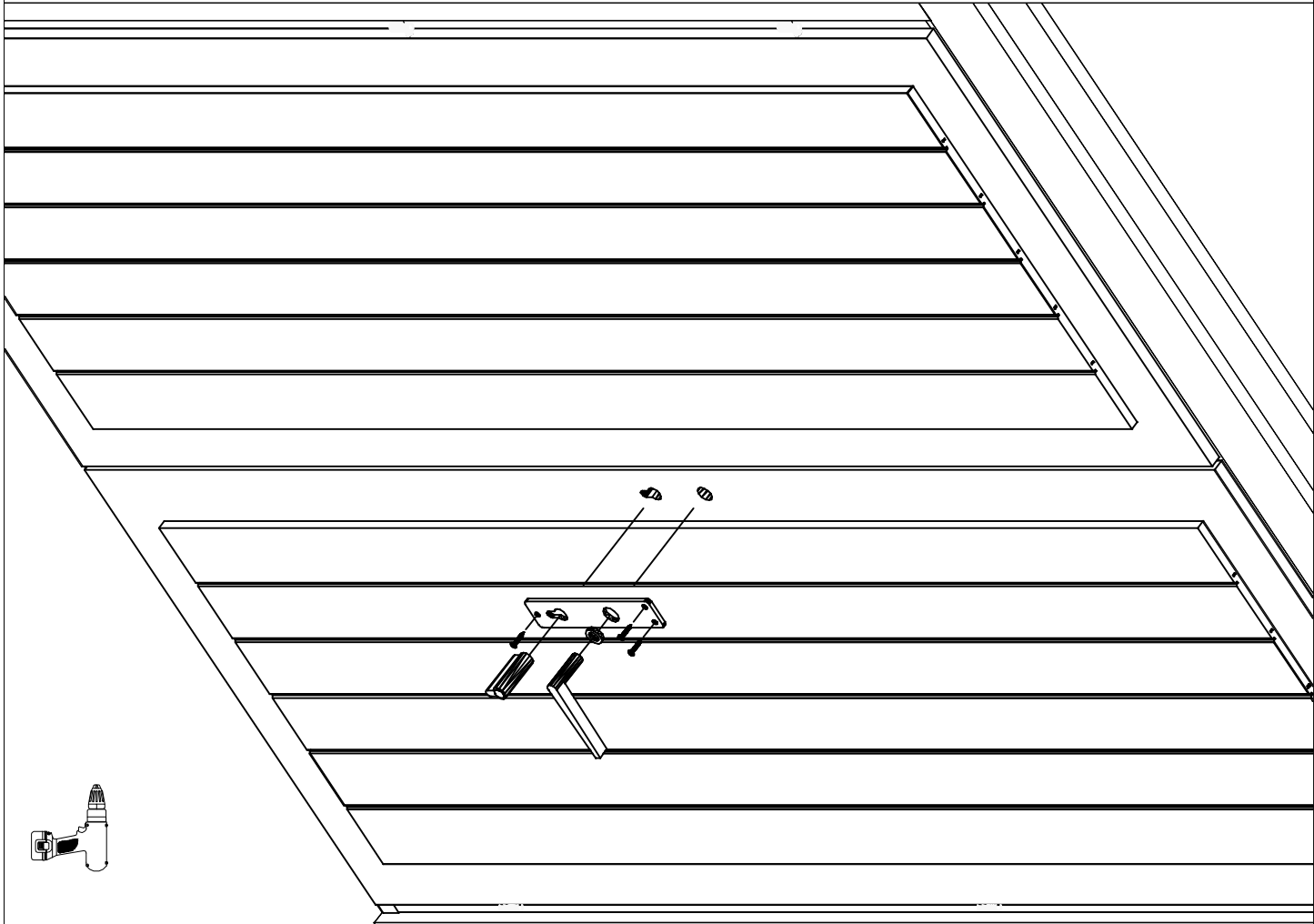
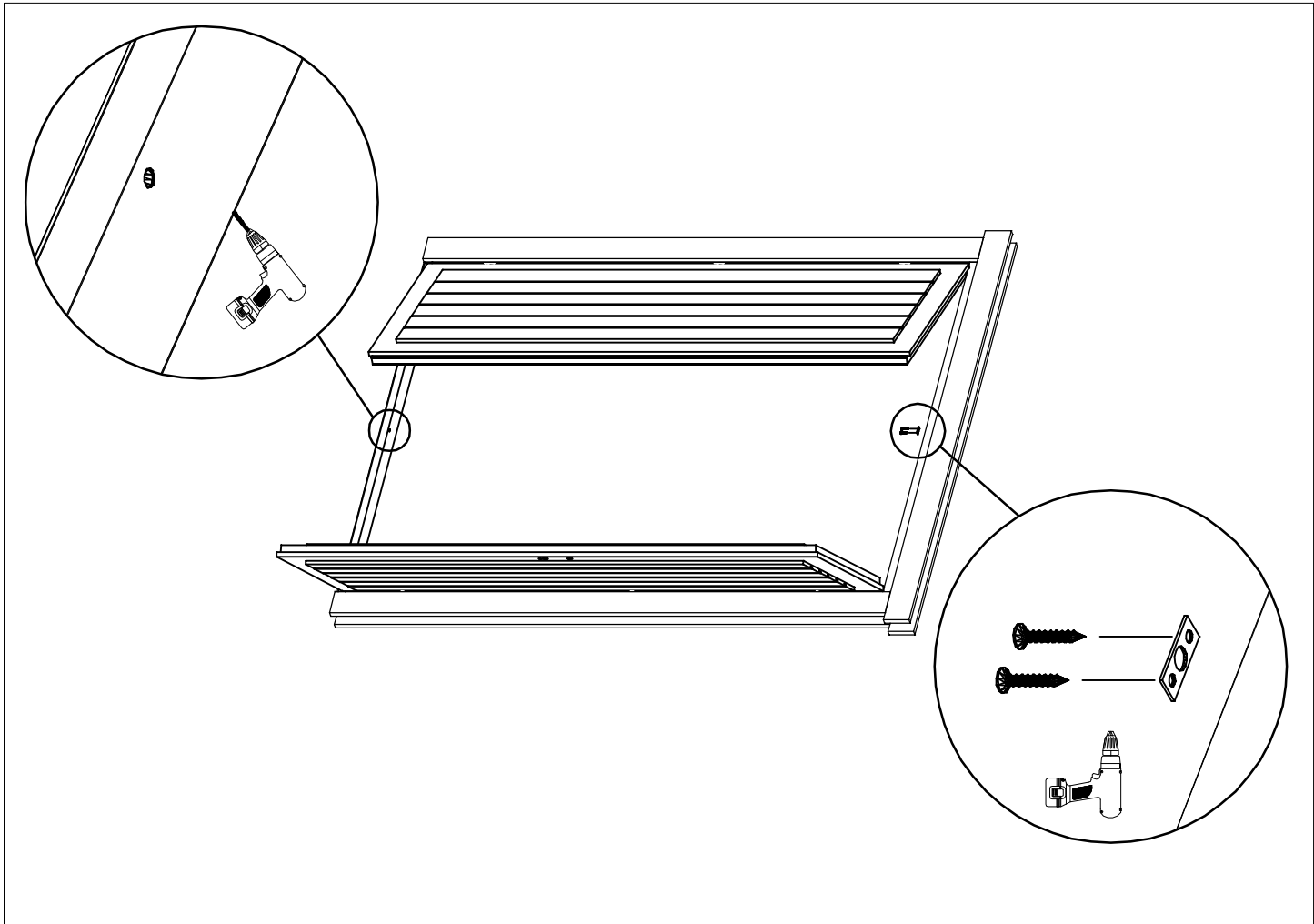

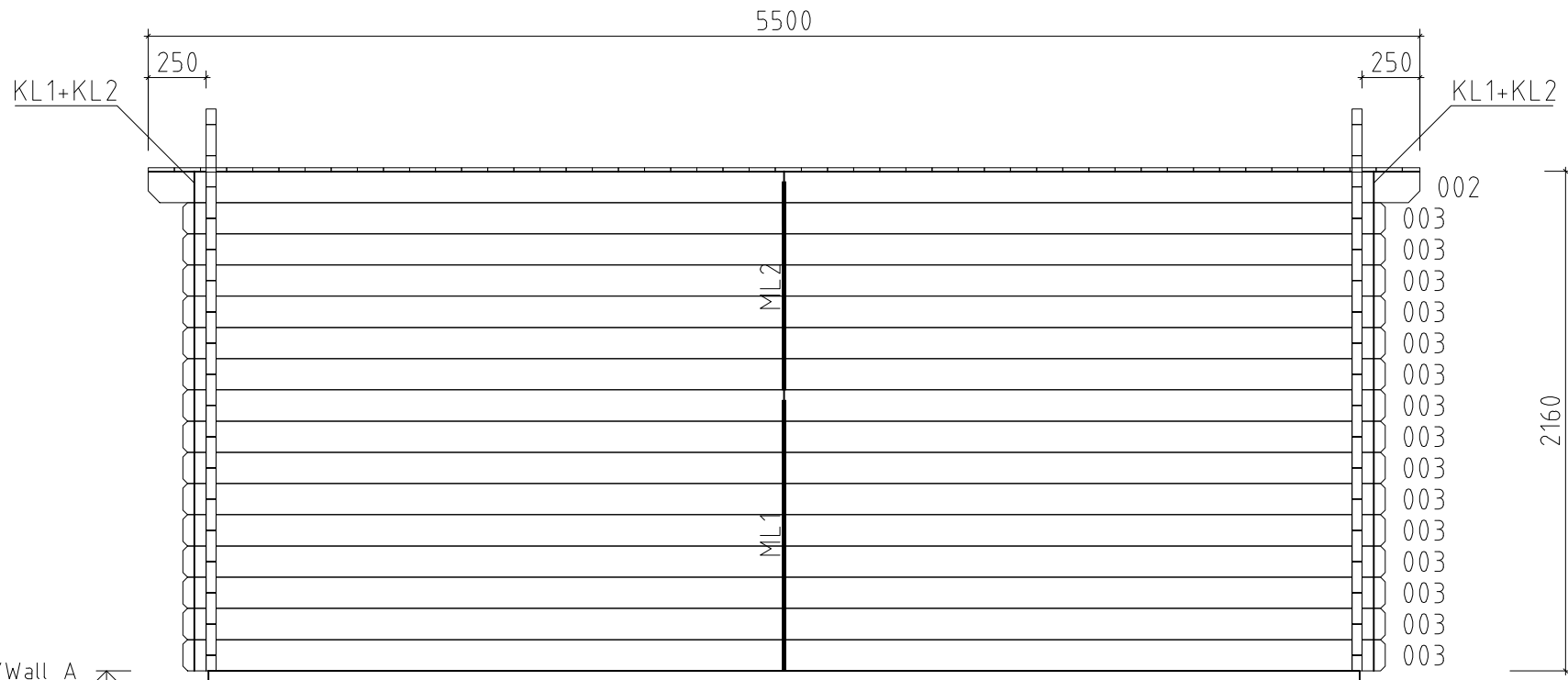

Wand/Wall A ↗

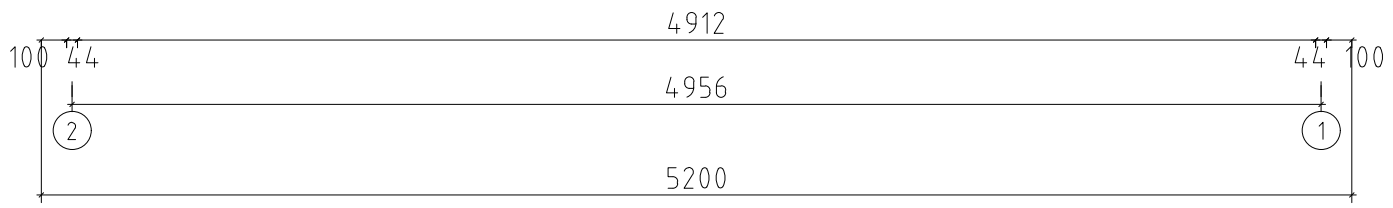

Name	Rusholme 400x500_44		
Zeichnung/Drawing	WAND/WALL A		
Profil/Profile	4.4x13.5	Datum/Date	27.02.2023

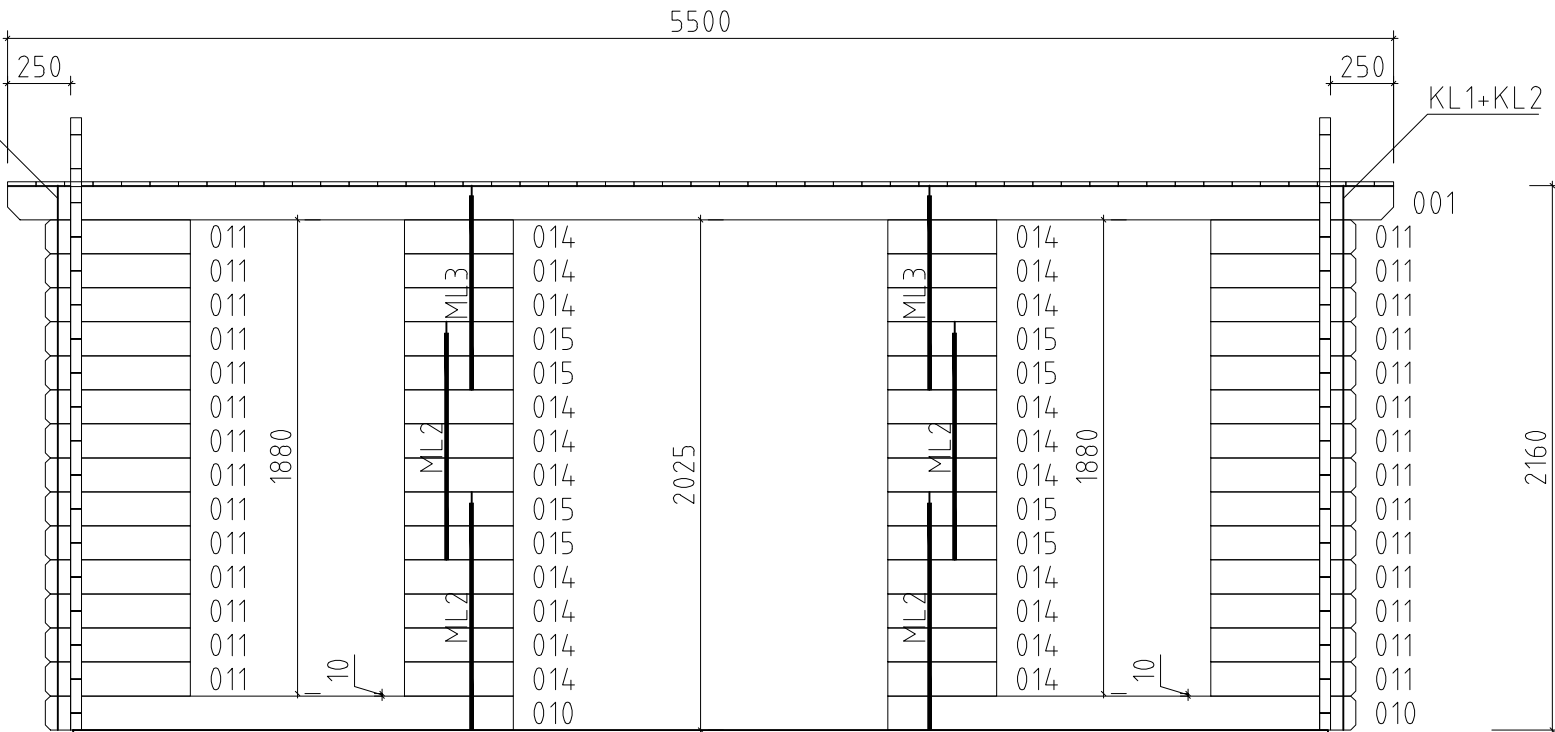
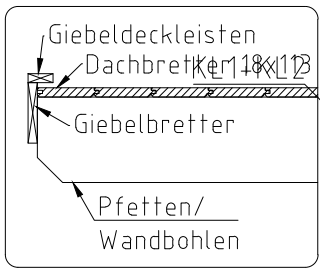

Wand/Wall B ↗

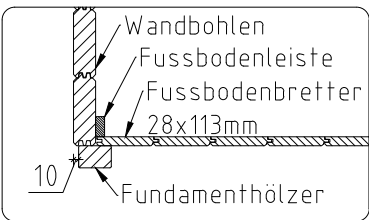
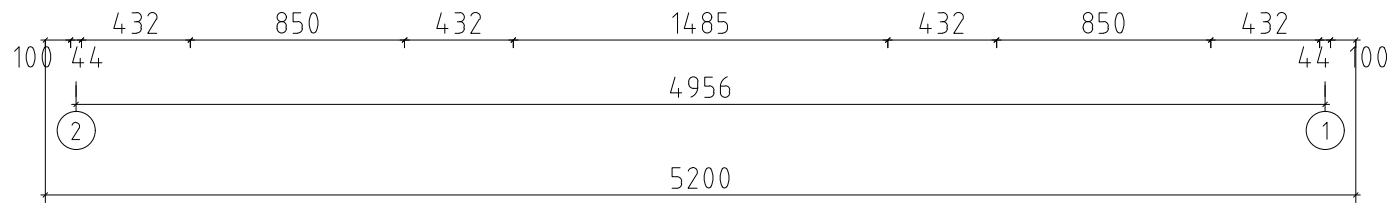

Name	Rusholme 400x500_44		
Zeichnung/Drawing	WAND/WALL B		
Profil/Profile	4.4x13.5	Datum/Date	27.02.2023

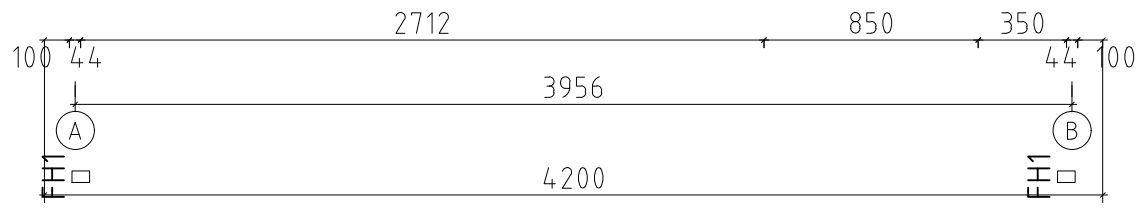
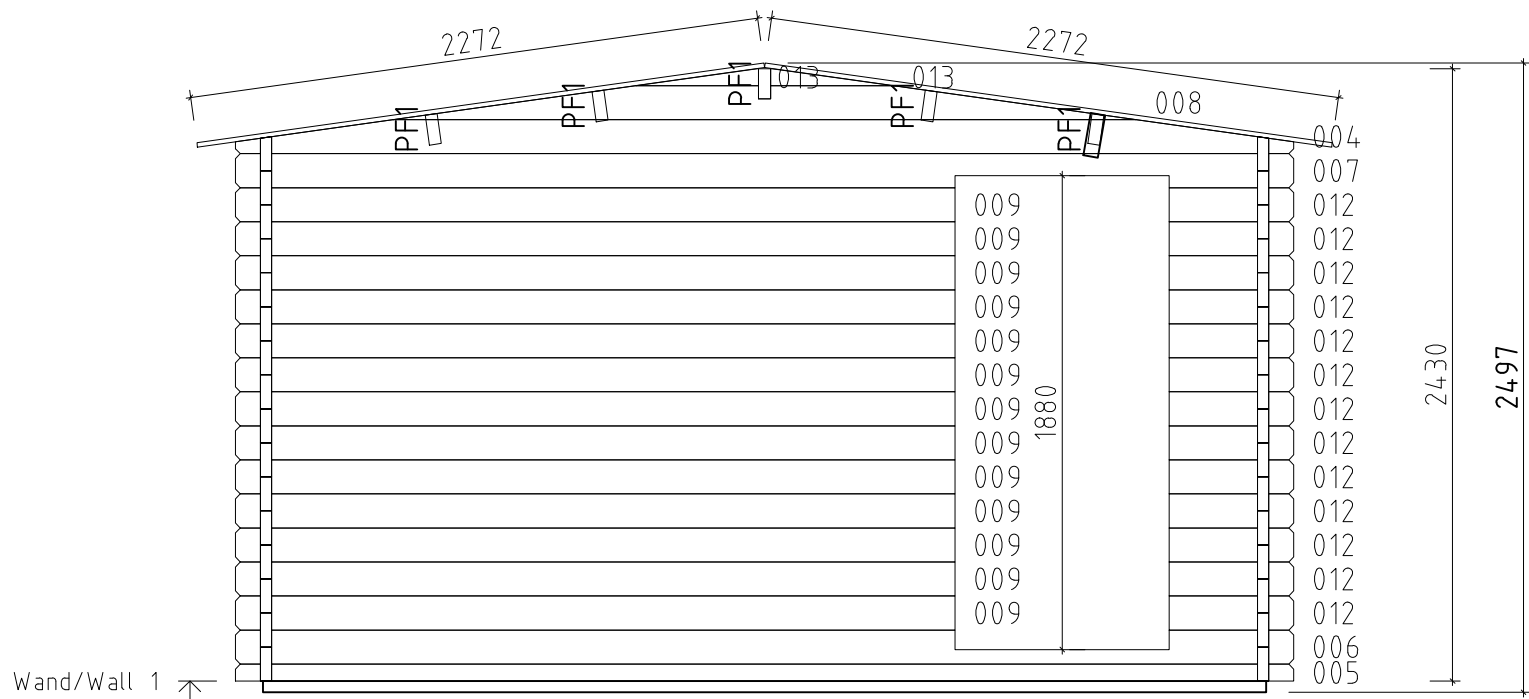

Name	Rusholme 400x500_44		
Zeichnung/Drawing	WAND/WALL 1		
Profil/Profile	4.4x13.5	Datum/Date	27.02.2023

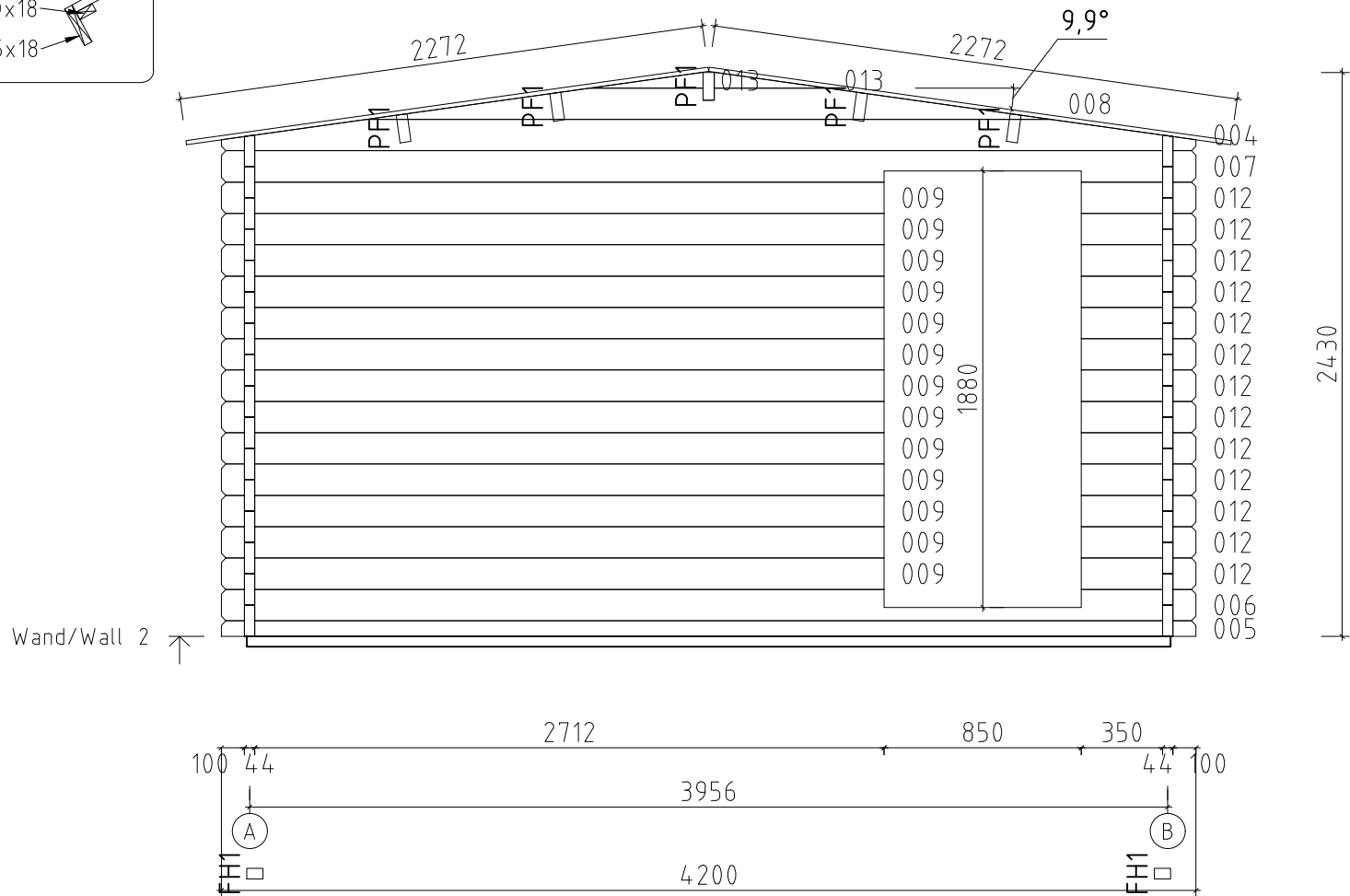
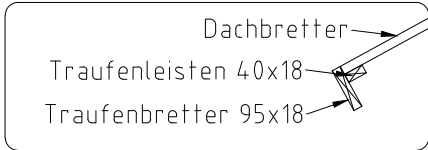

Name	Rusholme 400x500_44		
Zeichnung/Drawing	WAND/WALL 2		
Profil/Profile	4.4x13.5	Datum/Date	27.02.2023