

Name	Wolverine 400x598/44						
Zeichnung/Drawing	3D						
Mafstab/Scale	1:40	Profil/Profile	4.4x13.5	Druck auf/ Print on	A3	Datum/Date	27.02.2023

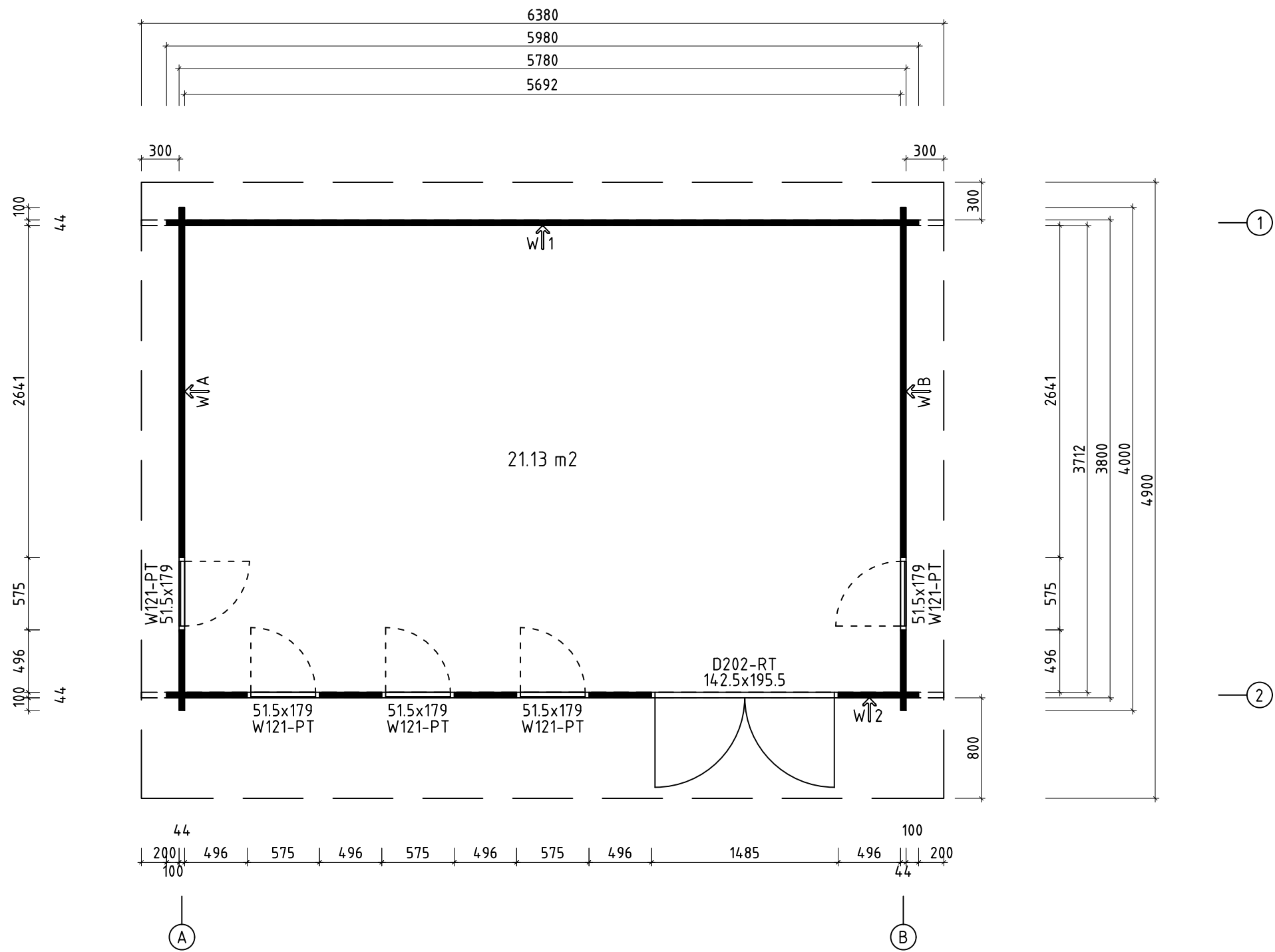

Q4 – Qualitätsklasse für Fenster und Türen/
Quality class for windows and doors

* Fenster und Türen sind ohne Sprossen
Windows and doors are without muntins

Name		Wolverine 400x598/44		
Zeichnung/Drawing		Grundplan; Plan		
Maßstab/Scale	1:40	Profil/Profile	4.4x13.5	Druck auf/ Print on
			A3	Datum/Date
				27.02.2023

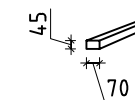
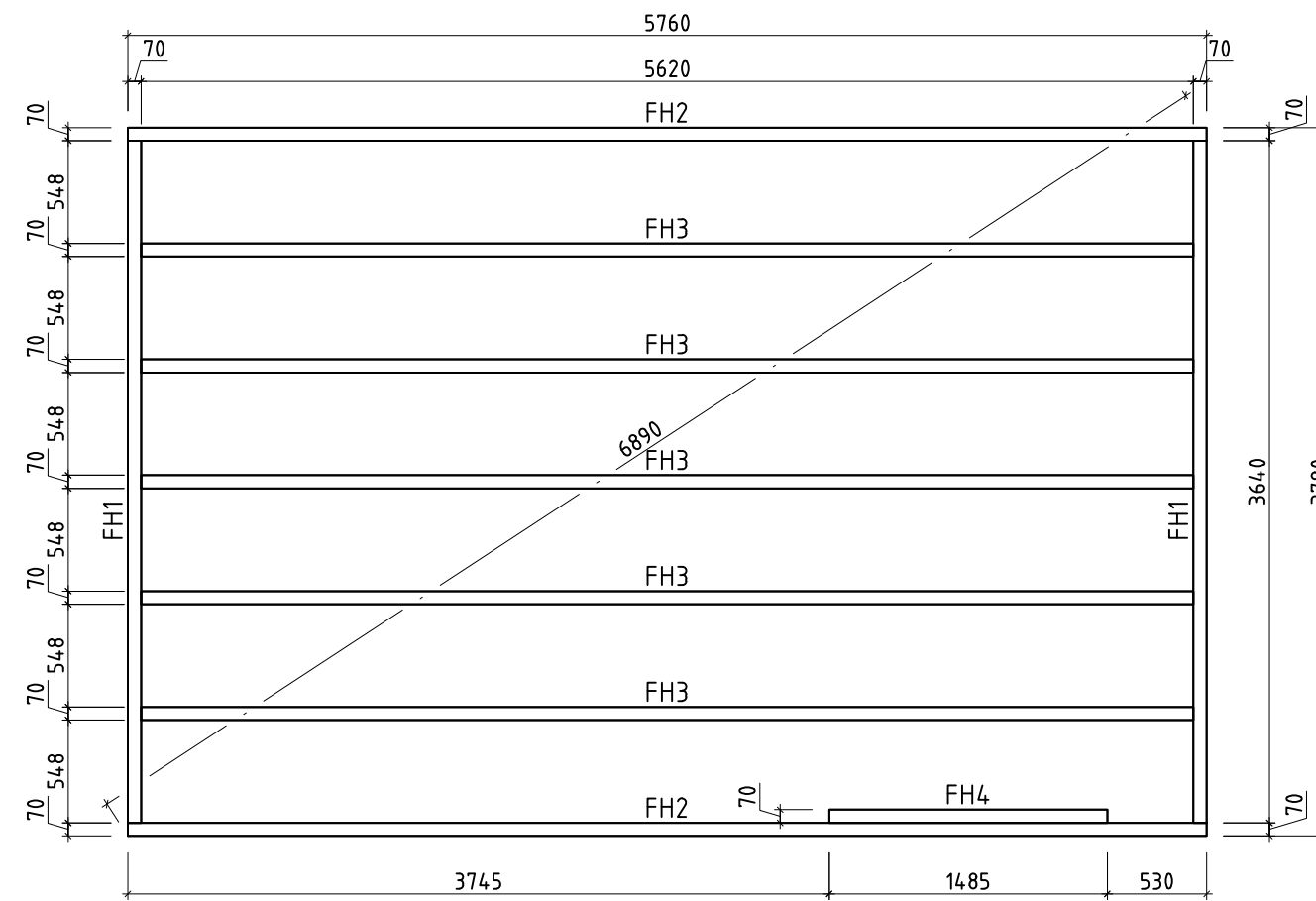

Name		Wolverine 400x598/44		
Zeichnung/Drawing		Lagerholzplan; Foundation beams		
Maßstab/Scale	1:40	Profil/Profile	4.4x13.5	Druck auf/Print on
			A3	Datum/Date
				27.02.2023

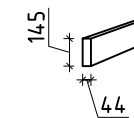
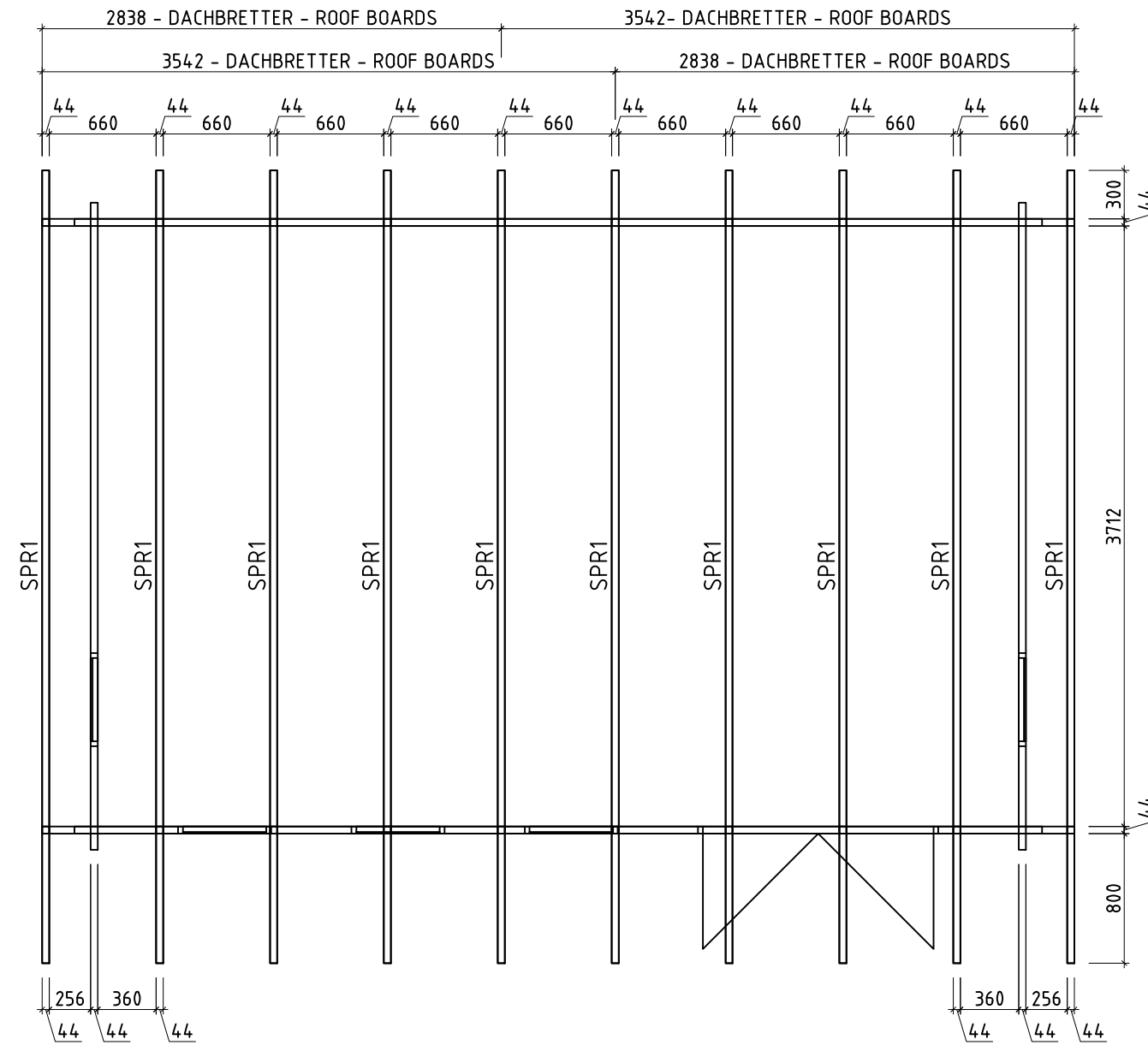

Name		Wolverine 400x598/44		
Zeichnung/Drawing		Sparren; Rafters		
Maßstab/Scale	1:40	Profil/Profile	4.4x13.5	Druck auf/Print on
			A3	Datum/Date
				27.02.2023

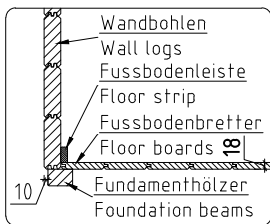
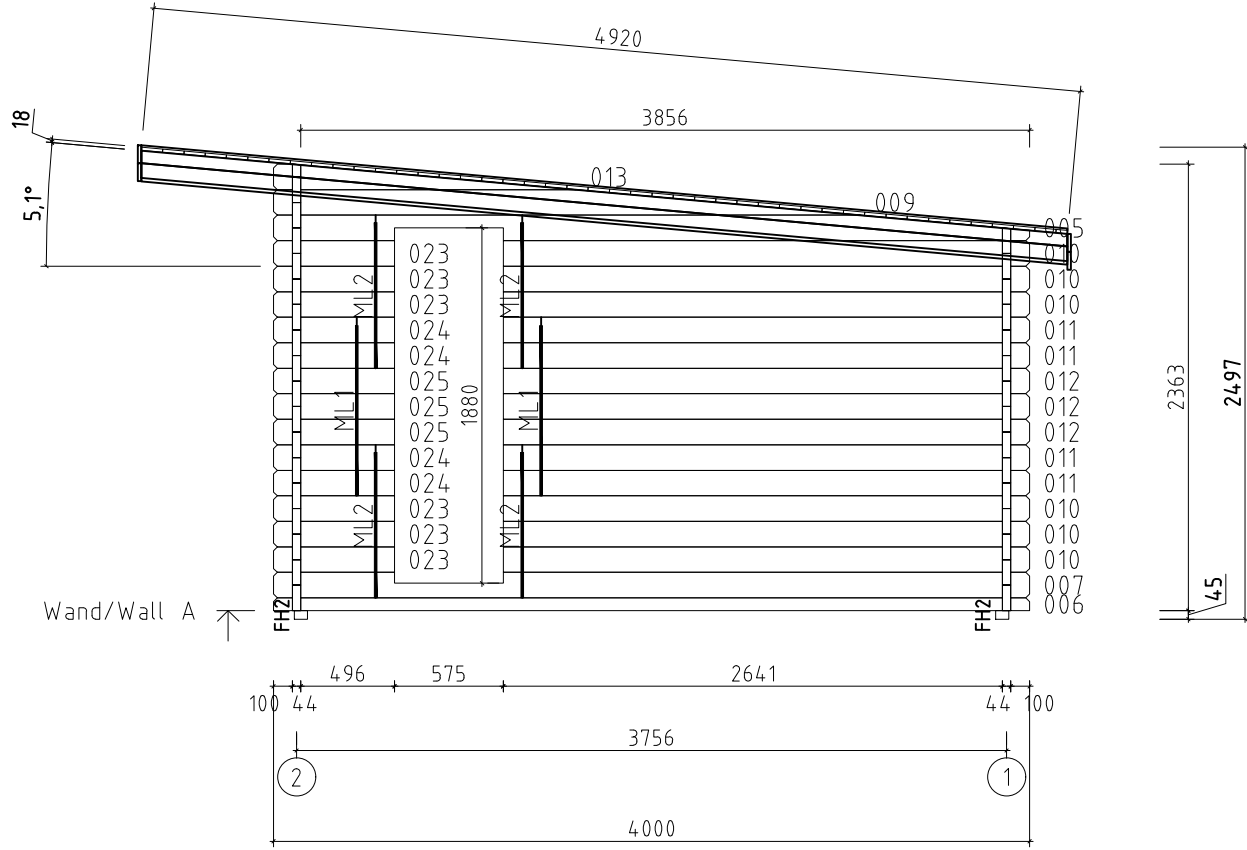
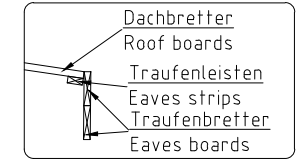
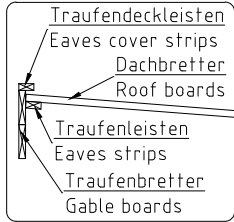

Name	Wolverine 400x598/44		
Zeichnung/Drawing	WAND/WALL A		
Maßstab/Scale	1:40	Profil/Profile	4.4x13.5
Druck auf/Print on	A4	Datum/Date	27.02.2023

Wand/Wall B

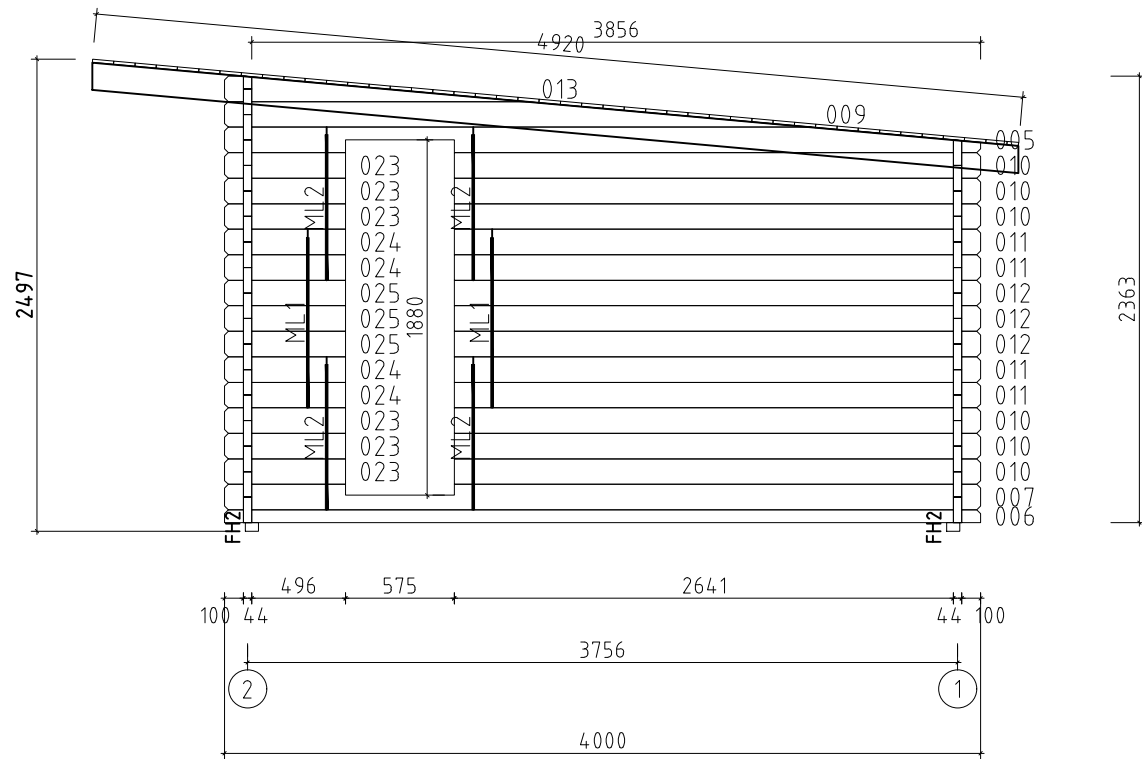

Name				Wolverine 400x598/44			
Zeichnung/Drawing				WAND/WALL B			
Maßstab/Scale	1:40	Profil/Profile	4.4x13.5	Druck auf/Print on	A4	Datum/Date	27.02.2023

- Giebeldeckleisten
Gable cover boards
- Dachbretter
Roof boards
- Giebelbretter
Gable boards
- Pfetten/Wandbohlen
Purlins/Wall log

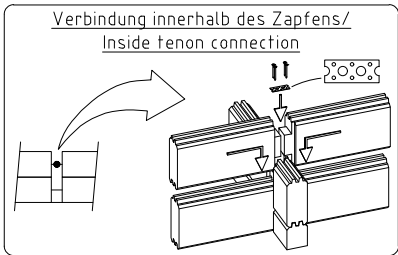
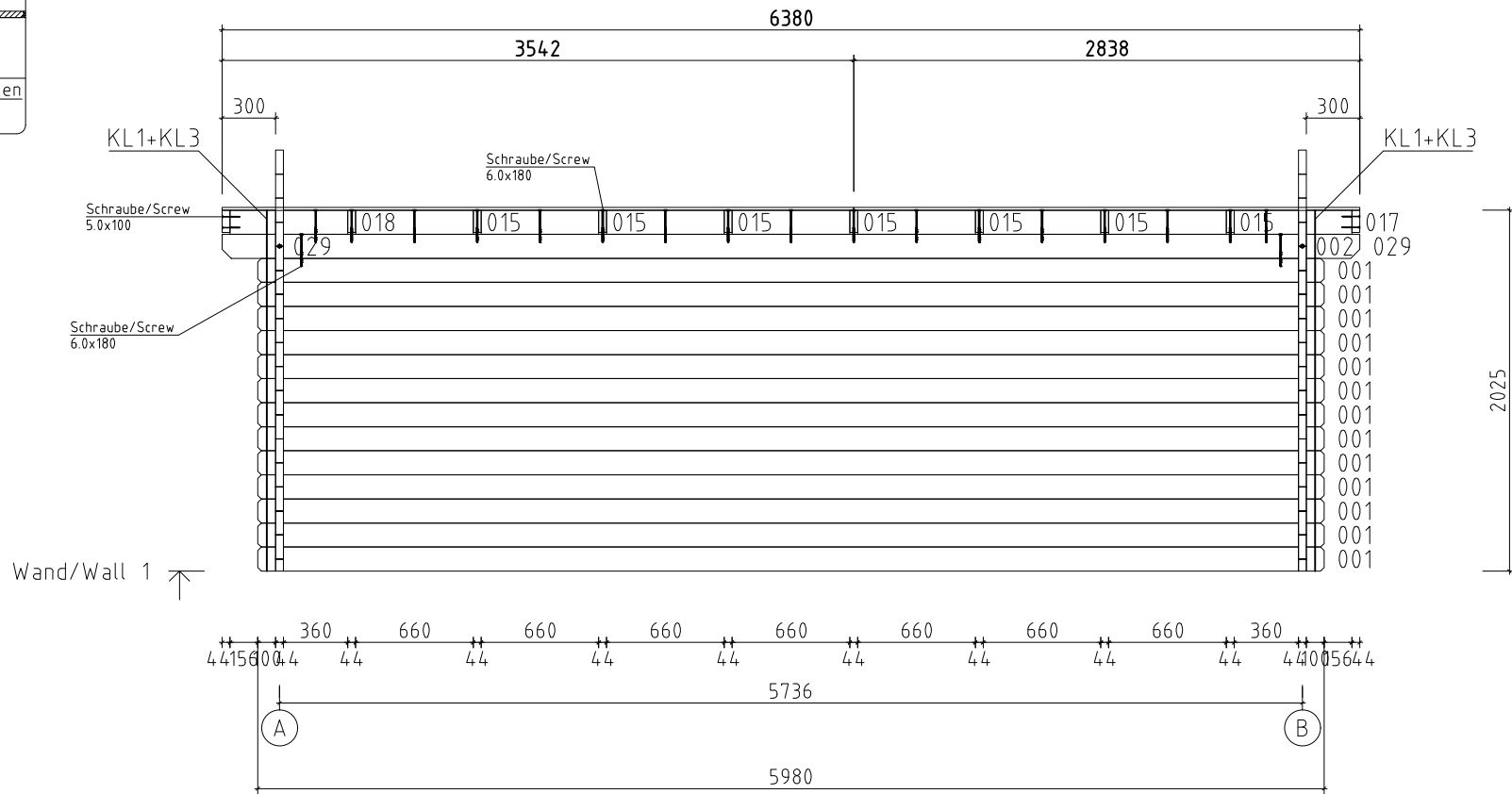

Name				Wolverine 400x598/44	
Zeichnung/Drawing				WAND/WALL 1	
Maßstab/Scale	1:40	Profil/Profile	4.4x13.5	Druck auf/Print on	A4
				Datum/Date	27.02.2023

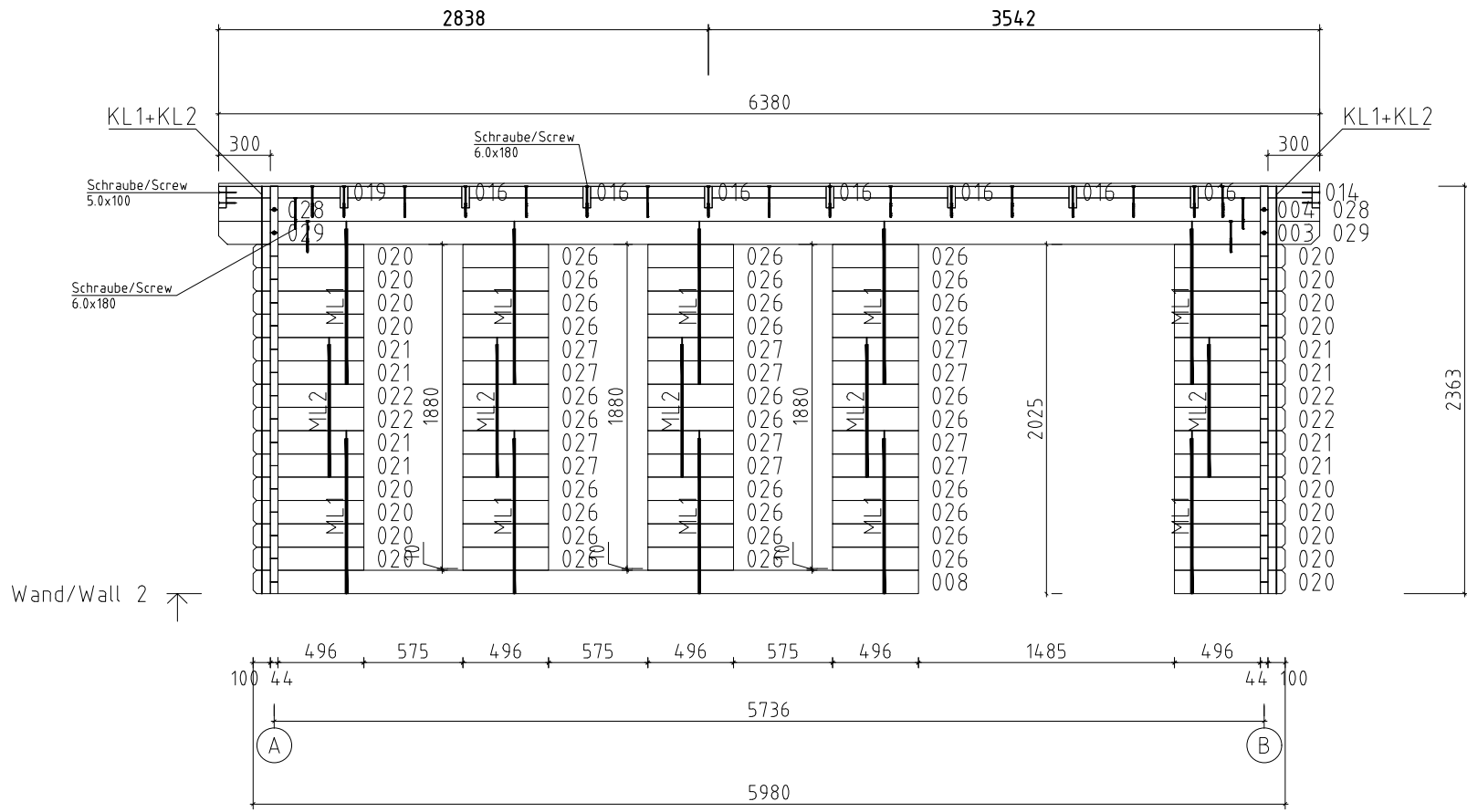



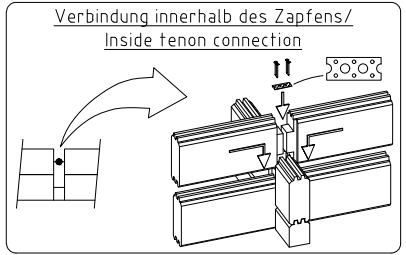



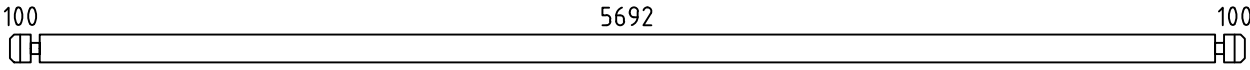
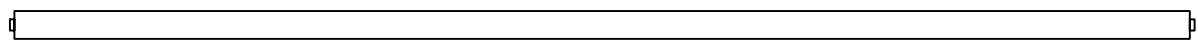
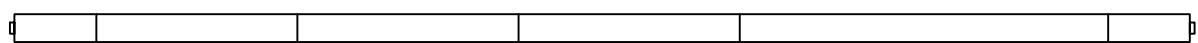
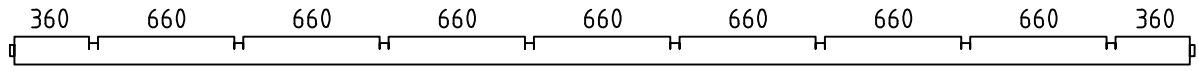
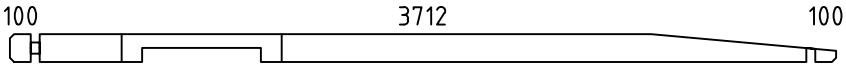
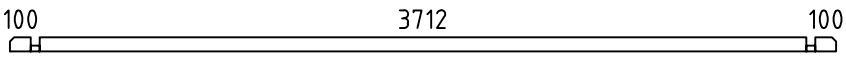
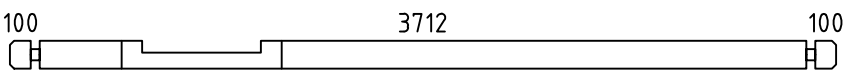
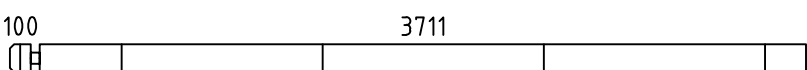
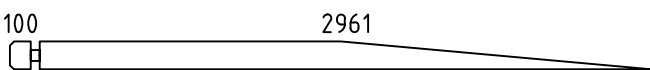
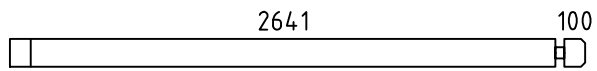
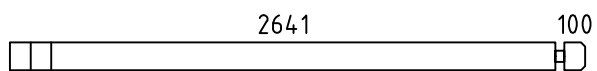
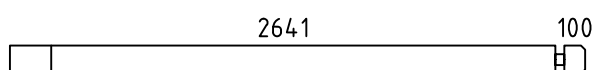
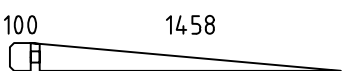
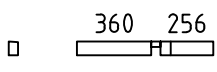
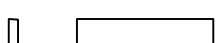
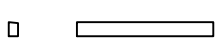
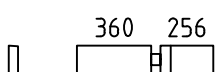
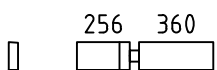
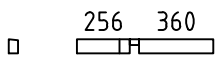
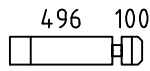
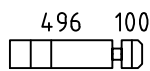
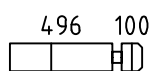
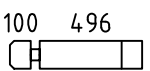
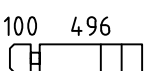
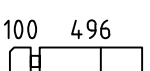

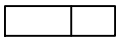

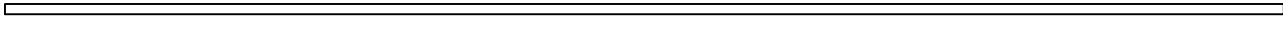
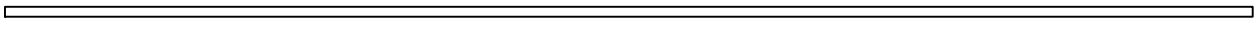
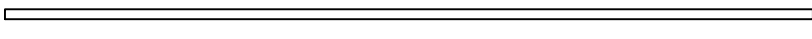













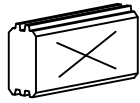

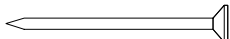
Wand/Wall 2 ↗

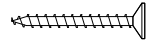
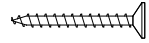
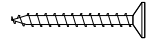
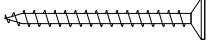
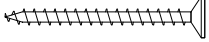
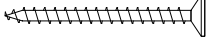
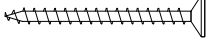
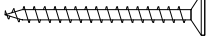
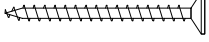
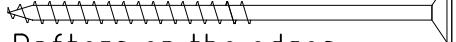
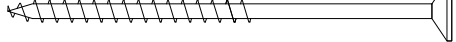
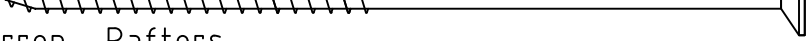
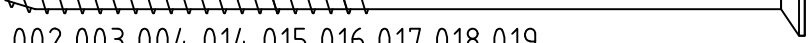

Name				Wolverine 400x598/44	
Zeichnung/Drawing				WAND/WALL 2	
Maßstab/Scale	1:40	Profil/Profile	4.4x13.5	Druck auf/ Print on	A4
				Datum/Date	27.02.2023

Pos	Teileliste/Specification Wolverine 400x598/44	Stck Pcs.	Profil Profile (mm)	Länge Length (mm)
	<u>Achtung!</u> Die Giebelbohlen können teilweise schon vormontiert sein! Bitte beachten - diese erscheinen nicht ganz so wie in der Teileliste beschrieben.			
	<u>Notice!</u> The gable pieces can be partly pre-assembled! Please notice - those differ from the description given in the specification list.			
001		13	44x135	5980
002		1	44x135	5736
003		1	44x135	5736
004		1	44x135	5736
005		2	44x135	4000
006		2	44x68	4000
007		2	44x135	4000
008		1	44x135	3855
009		2	44x135	3105
010		12	44x135	2785
011		8	44x135	2785
012		6	44x135	2785
013		2	44x135	1602
014		1	44x68	660
015		7	44x135	660
016		7	44x68	660
017		1	44x135	660
018		1	44x135	660
019		1	44x68	660
020		17	44x135	640
021		8	44x135	640
022		4	44x135	640
023		12	44x135	640
024		8	44x135	640
025		6	44x135	640
Kood	Wolverine 400x598/44	Materjal		Leht 1/4

Pos	Teileliste/Specification Wolverine 400x598/44		Stck Pcs.	Profil Profile (mm)	Länge Length (mm)
026			30	44x135	496
027			12	44x135	496
028	0 256 		2	44x135	322
029			4	44x135	322
FH2	FUNDAMENTHOLZ (imprägniert) - FOUNDATION BEAM (impregnated) 		2	70x45	5760
FH3	FUNDAMENTHOLZ (imprägniert) - FOUNDATION BEAM (impregnated) 		5	70x45	5620
FH1	FUNDAMENTHOLZ (imprägniert) - FOUNDATION BEAM (impregnated) 		2	70x45	3640
FH4	FUNDAMENTHOLZ (imprägniert) - FOUNDATION BEAM (impregnated) 		1	70x45	1485
SPR1	SPARREN - RAFTERS 		10	44x145	4933
	DACHBRETTER - ROOF BOARDS		44+1	113x18	3542
	DACHBRETTER - ROOF BOARDS		44+1	113x18	2838
	FUSSBODENBRETTER - FLOOR BOARDS		51+1	113x18	3707
	DECKENLEISTEN - CEILING STRIPS	 ✓		15x28	25,0 lfm/rm
	FUSSBODENLEISTEN - FLOOR STRIPS	 ✓		18x40	21,0 lfm/rm
G01-1	GIEBELBRETTER - GABLE BOARDS 18x95	 ✓	4	18x95	4970
G05-1	GIEBELDECKLEISTEN - GABLE COVER STRIPS 18x40	 ✓	4	18x40	2460
T01-1	TRAUFENBRETTER - EAVES BOARDS 18x95		4	18x95	3190
T01-2	TRAUFENBRETTER - EAVES BOARDS 18x95		4	18x95	3208
T04-1	TRAUFENDECKLEISTEN - EAVES COVER STRIPS 18x40		2	18x40	3208
T06-1	TRAUFENLEISTEN - EAVES STRIPS 18x40	 ✓		18x40	13,0 lfm/rm
ML1	Metallstange - Metal bar		14	D10	900
ML2	Metallstange - Metal bar		13	D10	770
SH	SCHLAGHÖLZER - MOUNTING PIECES		3		
NG2 550	NÄGEL - NAILS 2.5x50 Dachbretter - Roof boards		968		
NG2 550	NÄGEL - NAILS 2.5x50 Fussbodenbretter - Floor boards		714		
Kood	Wolverine 400x598/44		Materjal		Leht 2/4

Pos	Teileliste/Specification Wolverine 400x598/44		Stck Pcs.	Profil Profile (mm)	Länge Length (mm)
SR3 030	Schrauben - Screws 3.0x30	Deckenleisten - Ceiling strips		50	
SR3 030	Schrauben - Screws 3.0x30	Fussbodenleisten - Floor strips		42	
SR3 030	Schrauben - Screws 3.0x30	Traufenleisten - Eaves strips		26	
SR35 45-01	3.5x45	Trims - Rahmleisten - Piirdeliistud		144	
SR3 545	Schrauben - Screws 3.5x45	Giebelbretter - Gable boards		44	
SR3 545	Schrauben - Screws 3.5x45	Giebeldeckleisten - Gable cover strips		24	
SR3 545	Schrauben - Screws 3.5x45	Traufenbretter - Eaves boards		64	
SR3 545	Schrauben - Screws 3.5x45	Traufendeckleisten - Eaves cover boards		16	
SR354 5-001	Schrauben - Screws 3.5x45	Verbindungsstreifen - Connecting strip		24	
SR57	Schrauben - Screws 5.0x100	Sparren an die Dachkanten - Rafters on the edges		8	
SR5 0100	Schrauben - Screws 5.0x100	Fundamenthölzer - Foundation beams		40	
SR63	Schrauben - Screws 6.0x180	Sparren - Rafters		16	
SR63	Schrauben - Screws 6.0x180	Pos 002,003,004,014,015,016,017,018,019		24	
VS	Verbindungsstreifen für verbinden der Wandbohlen - Connecting strip for connecting the wall parts			6	
KL1	Gewindestange - Threaded Rod M8			4	2000
KL2	Gewindestange - Threaded Rod M8			2	393
KL3	Gewindestange - Threaded Rod M8			2	55
KV M UT M8	Mutter - Nut M8			8	
KV S EIB M8X25	U-Scheibe - Washer M8 Ø25			8	
KV MU TJ M8	Befestigungsmutter - Fixing nut M8			4	
Kood	Wolverine 400x598/44		Materjal		Leht 3/4

Pos	Teileliste/Specification Wolverine 400x598/44	Stck Pcs.	Profil Profile (mm)	Länge Length (mm)
	<p>FENSTER/WINDOW Q4 W4-S44P-0XT-05151790</p> <p>W121-PT</p> <p>L1 18x90 L=755mm 2x L2 18x90 L=1910mm 4x L3 18x90 L=515mm 2x ✓</p> <p>DIN rechts; right handed</p>	5		
	<p>TÜR/DOOR Q4 D4-D44R-0XT-14251955</p> <p>D202-RT</p> <p>L1 18x90 L=1665mm 2x L2 18x90 L=1955mm 4x ✓</p> <p>DIN rechts; right handed</p>	1		
	<p>✓ - Bitte selber anpassen (falls nötig)! / Cut into length on site (if needed)!</p>			
Kood	Wolverine 400x598/44	Materjal	Leht	4/4

1

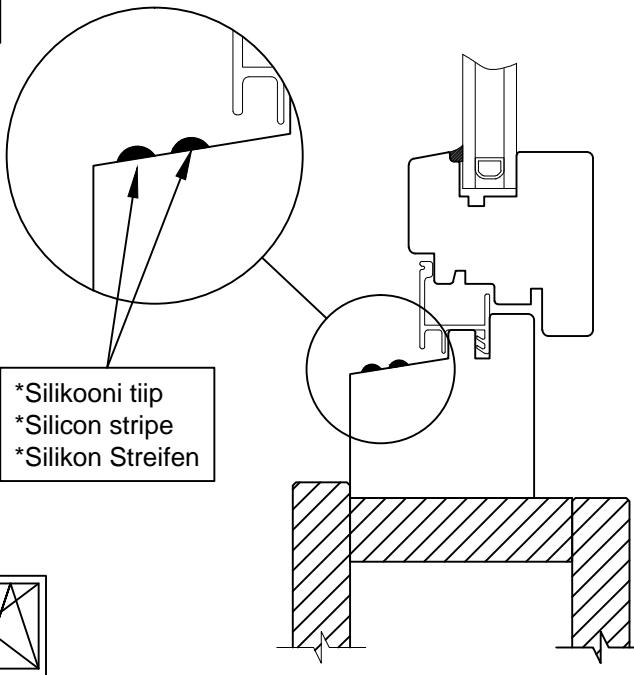

2

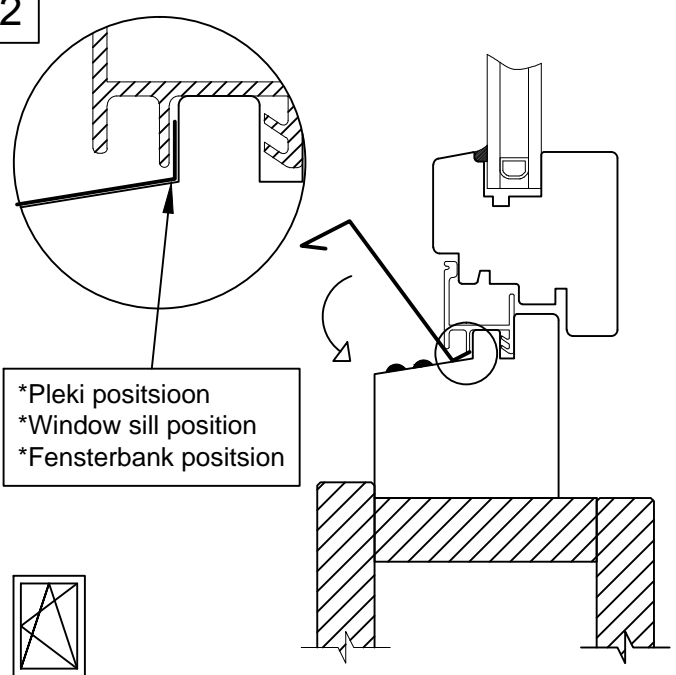

3

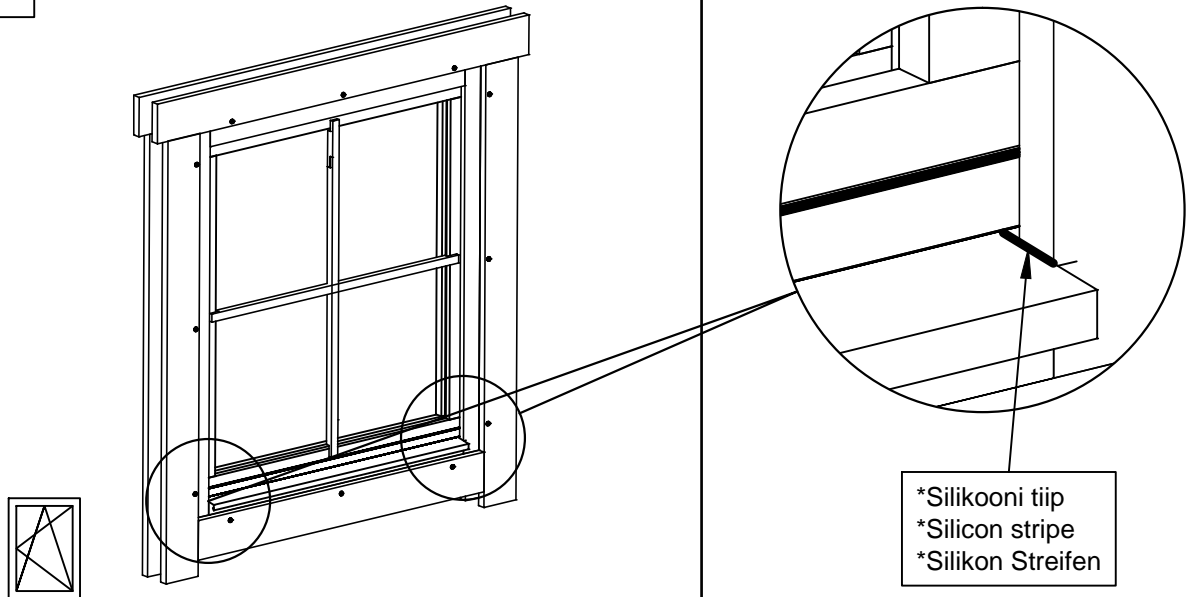

1

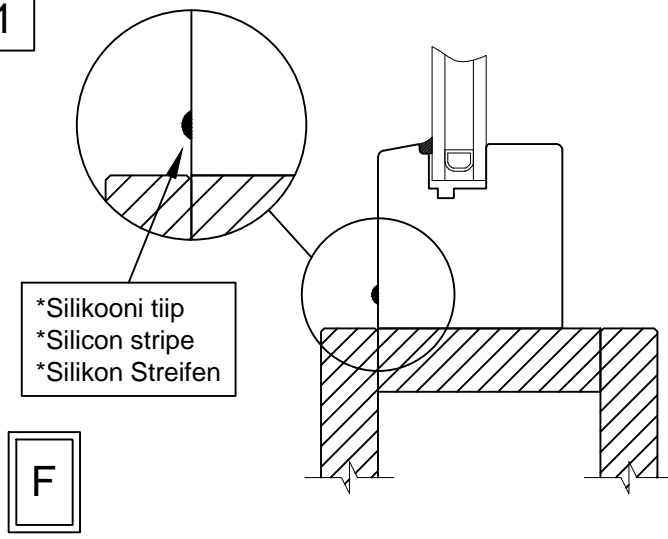

2

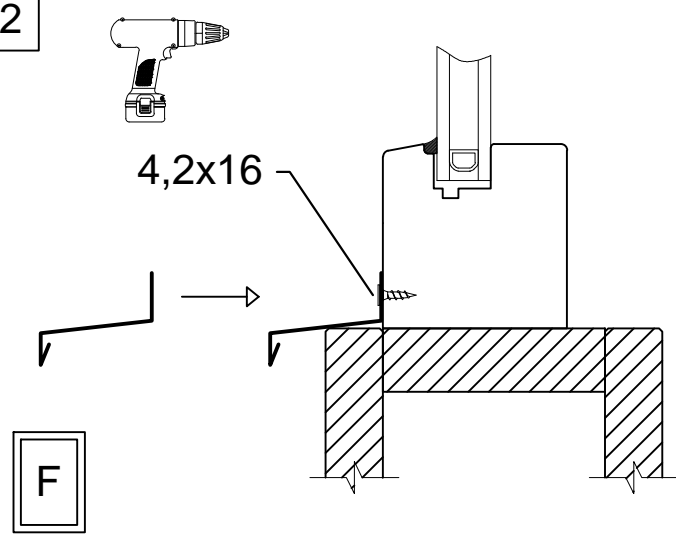

F

F

Aken	Q4-Q6	-	paigaldusjuhhis
Window	Q4-Q6	-	assembly instructions
Fenster	Q4-Q6	-	Montageanleitung

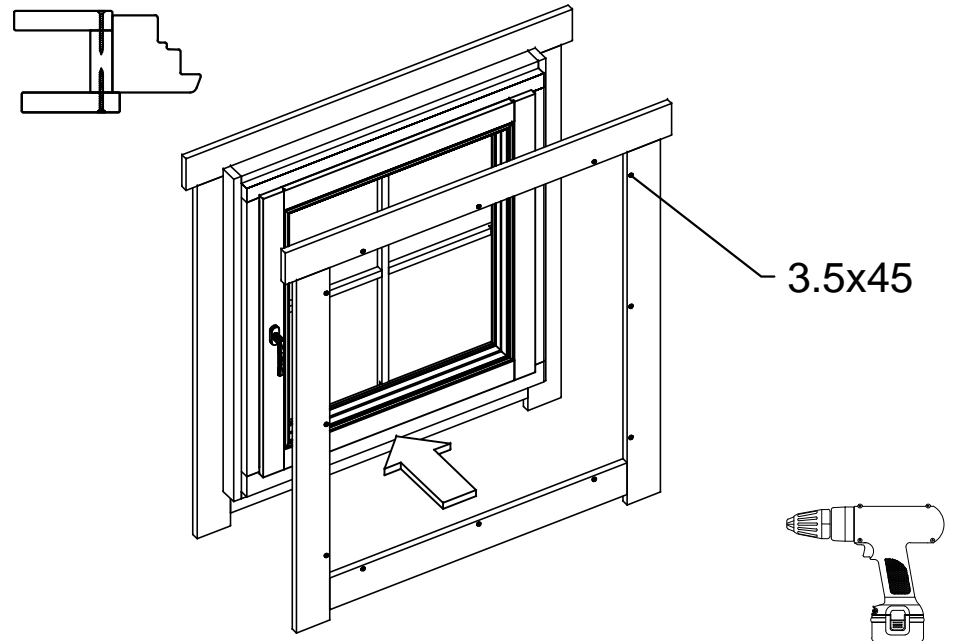
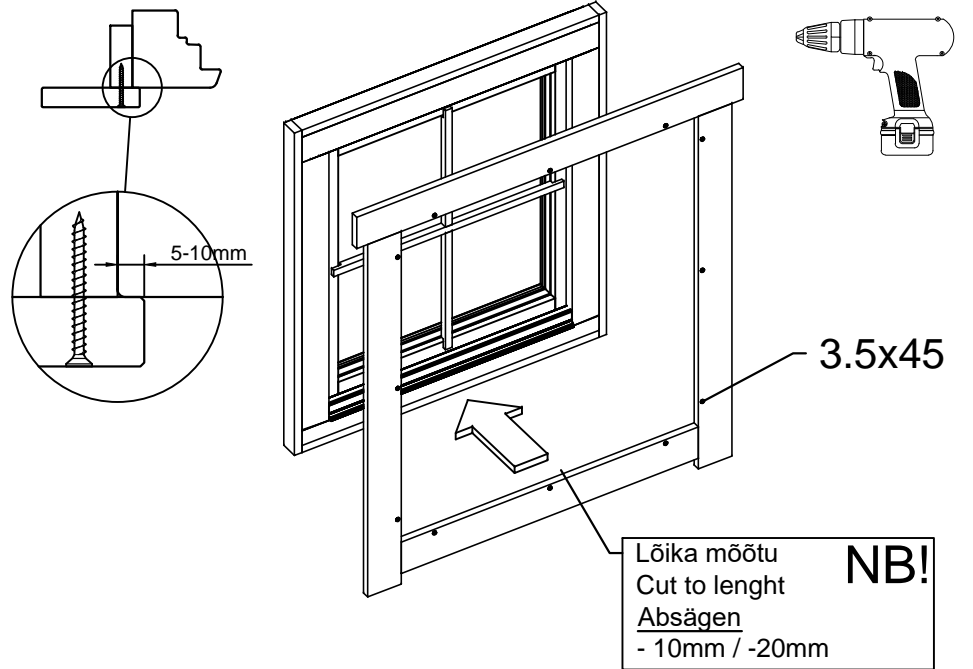
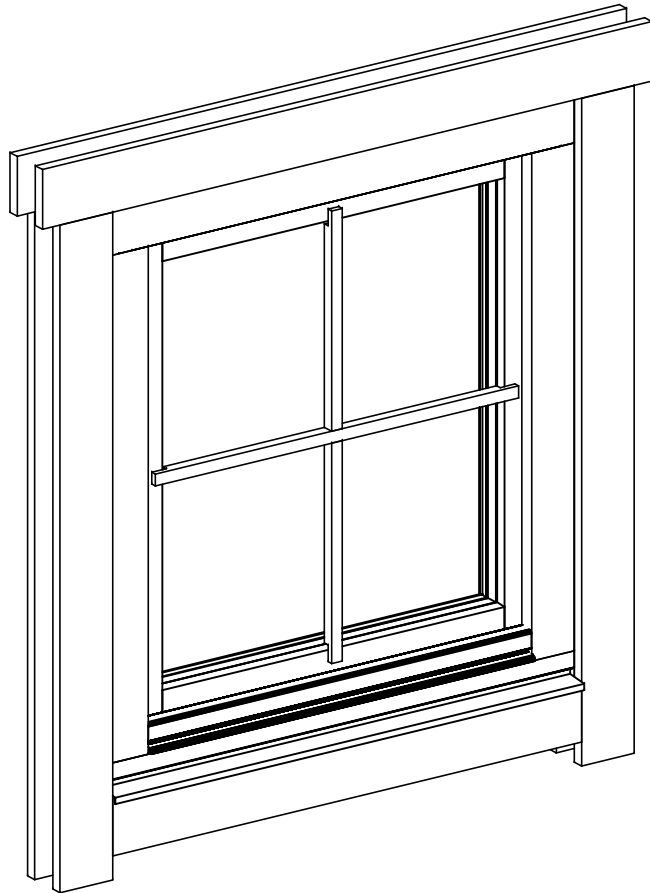

Ukse montaa 0 / Tür montage / Door assembly
(GH+ / SH)

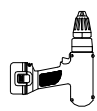
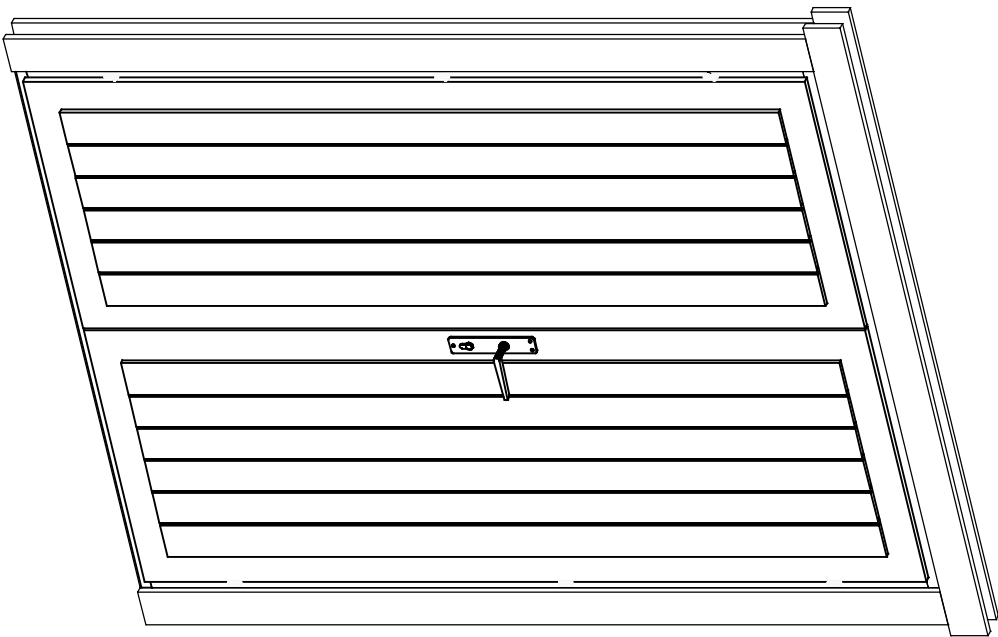

4.5x90

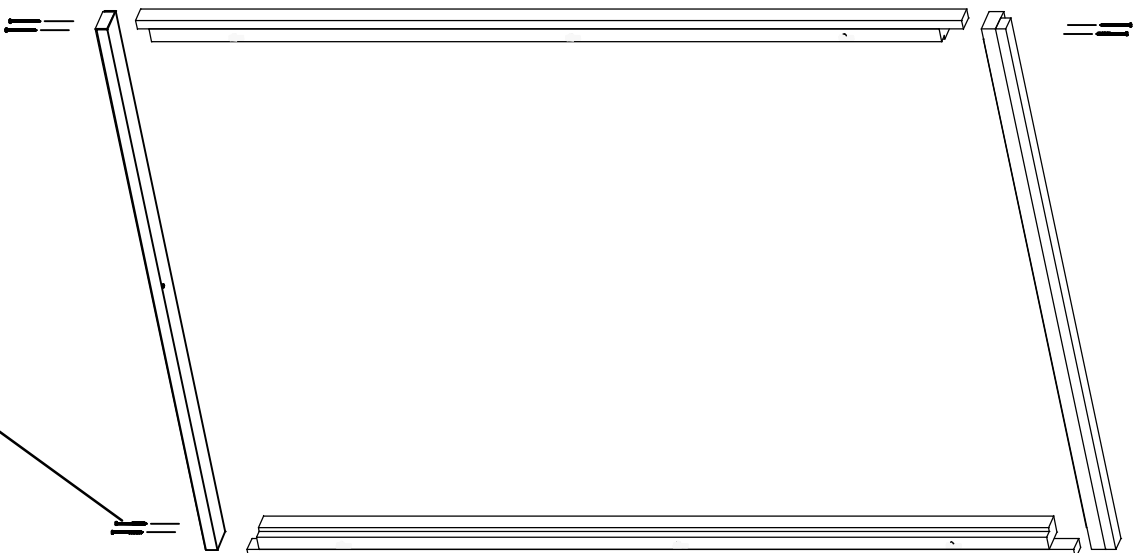

4.5x90



