

*Java*  
*Art. Nr. 4415802*  
*1/11*



04.02.2018

Art. Nr. 4415802

Groundplan - Grundplan - Plan de masse - Planimetria  
- Plattegrond - Põhiplaan

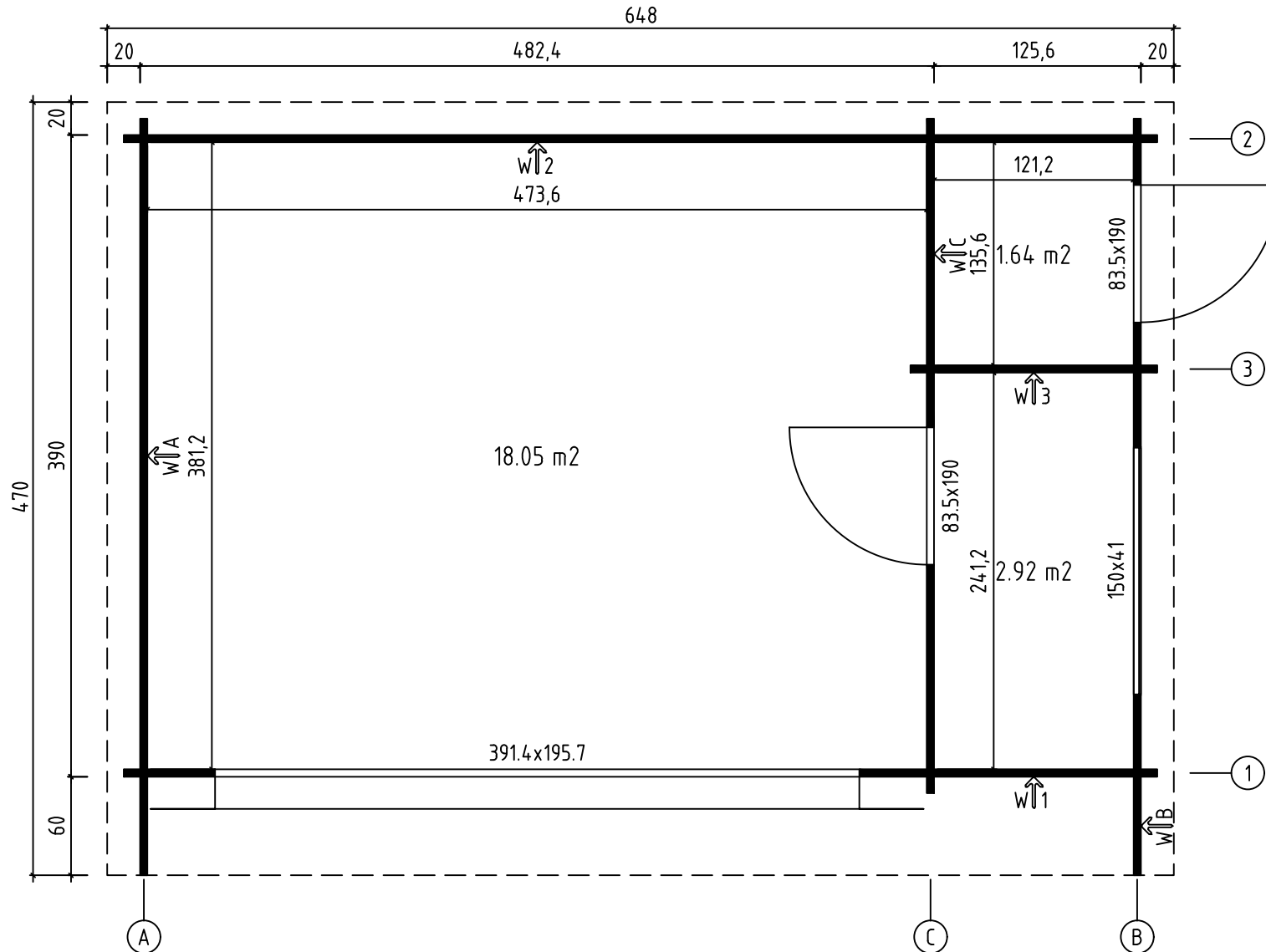

Art. Nr. 4415802

Foundation - Fundament - Fondation - Fundamenta -  
Fundering - Immutatud alusraam

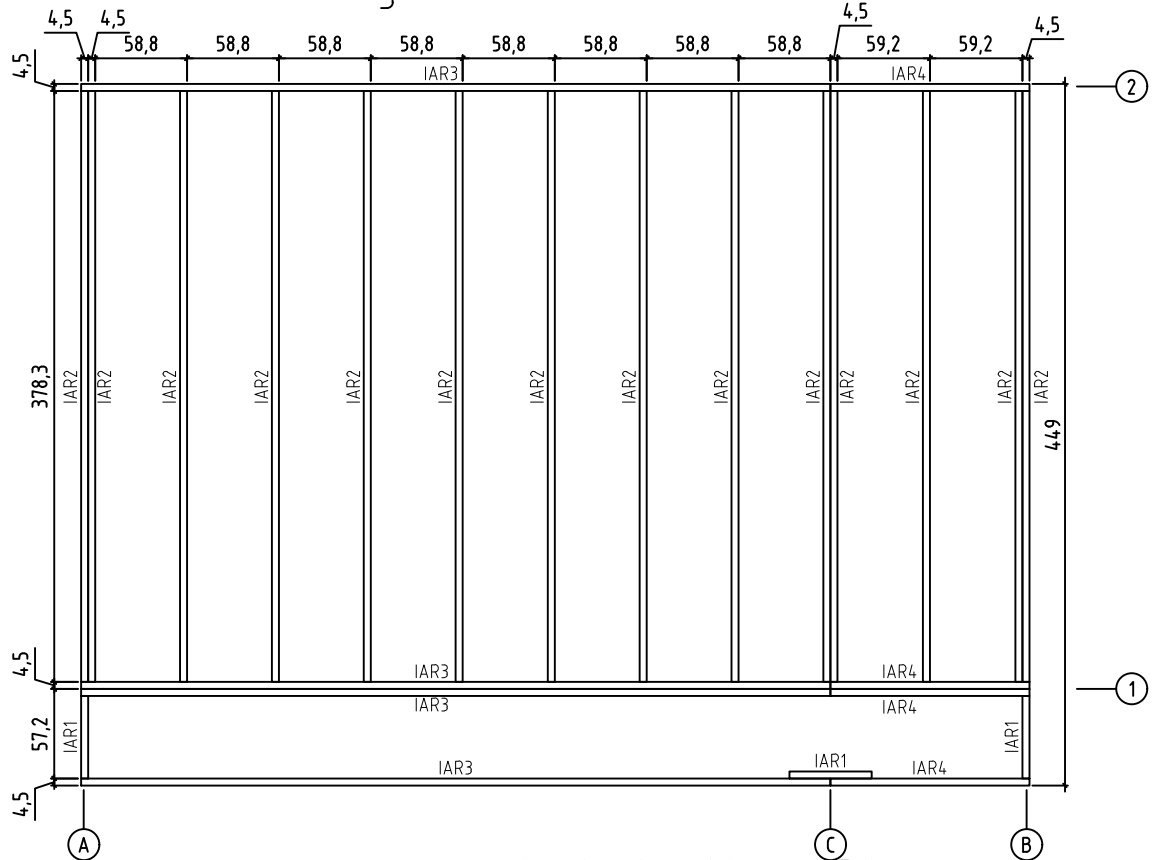

Floor boards - Fussbodenbretter - Plan  
pose plancher - Pavimento - Vloerhout - Põrandalaudis

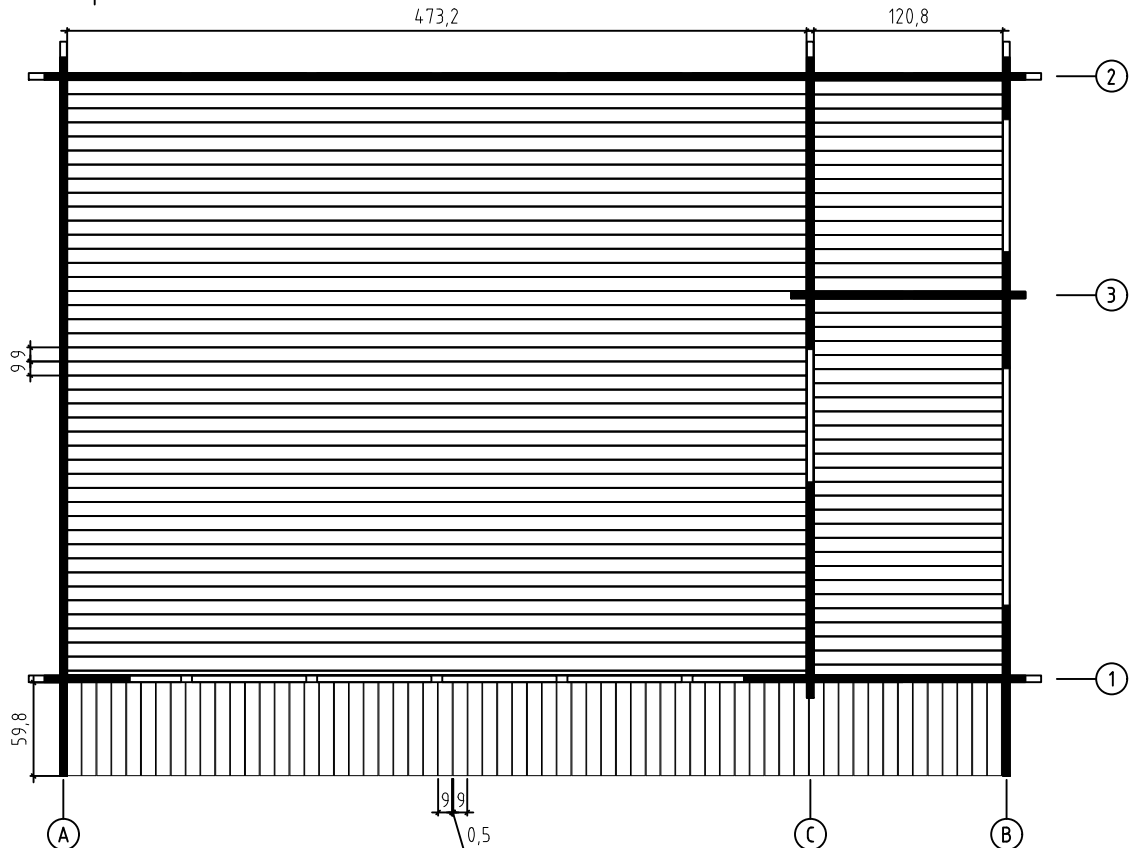

Terrace boards - Terrassenbretter - Plancher de terrasse -  
Piattaforme terrazzo - Terrasvloer - Terrassilaudis

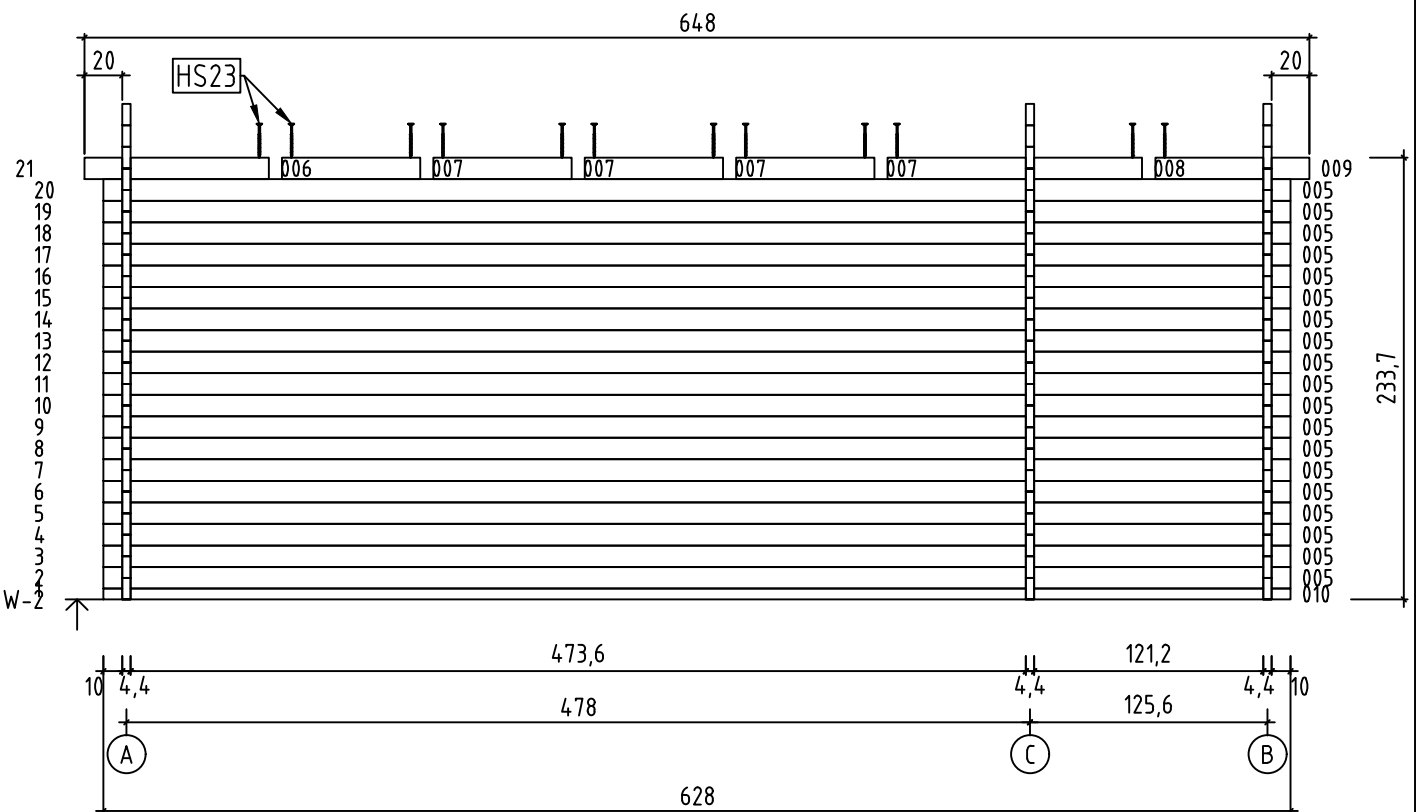
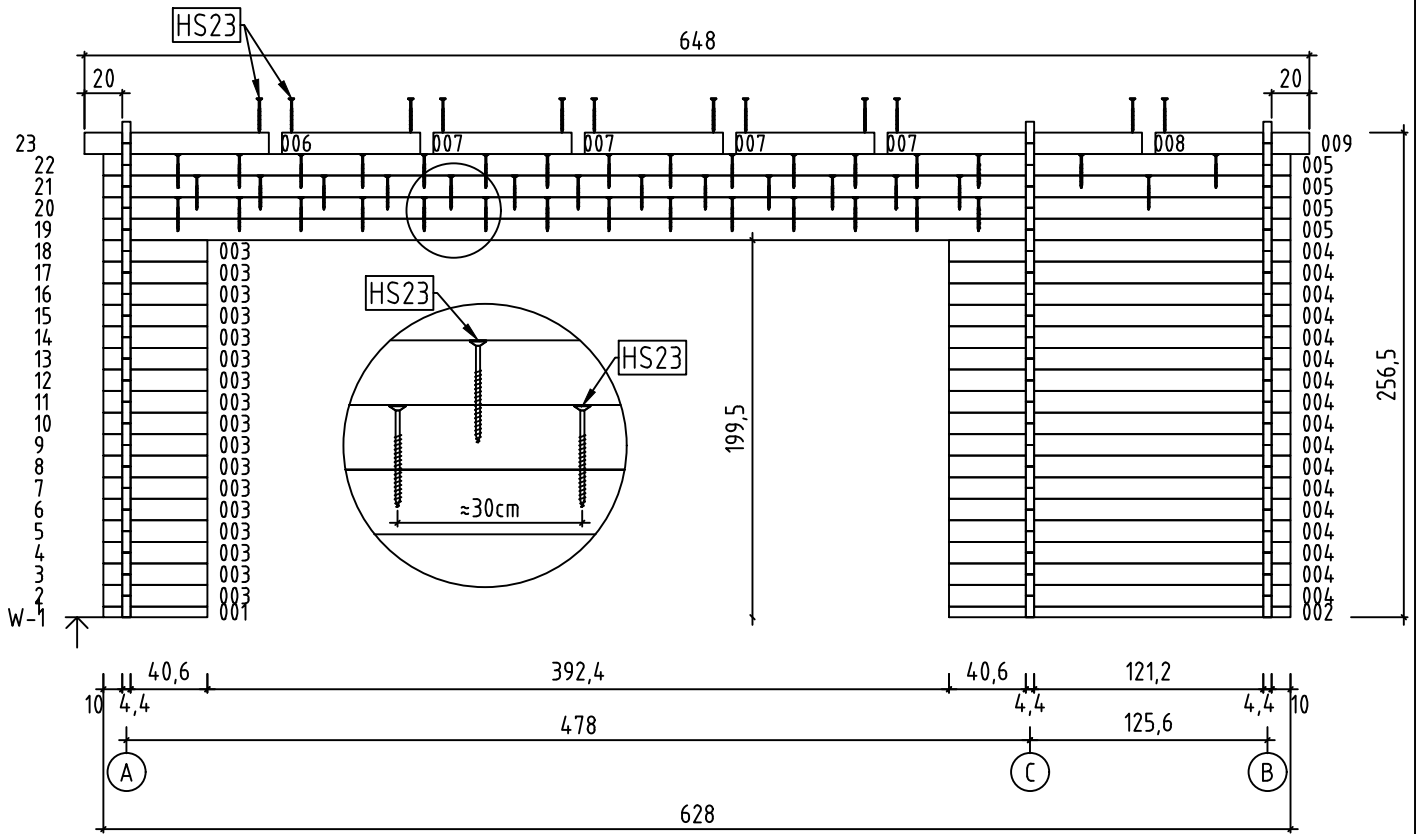

Art. Nr. 4415802

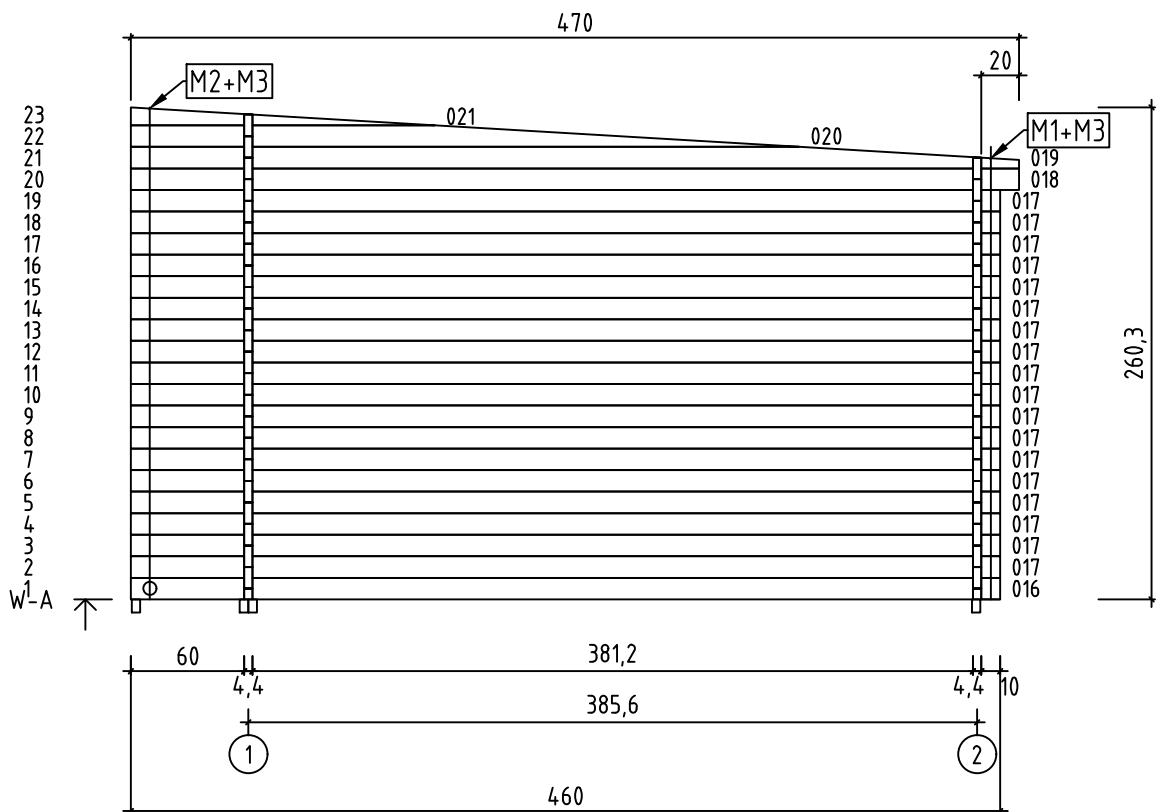
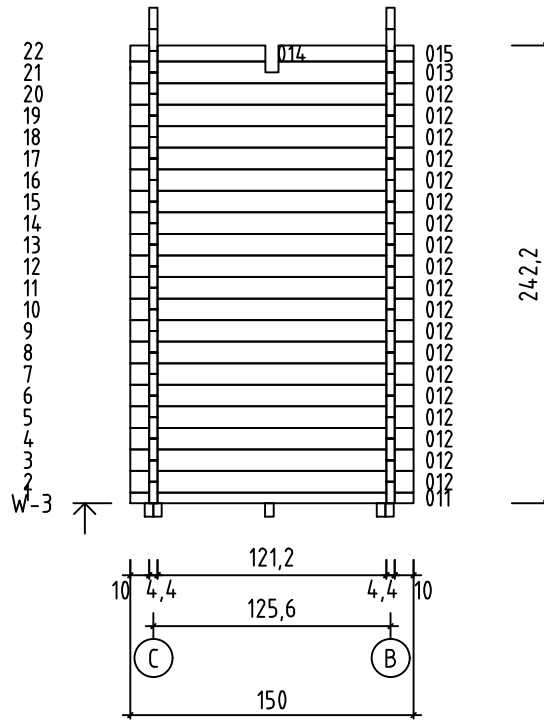



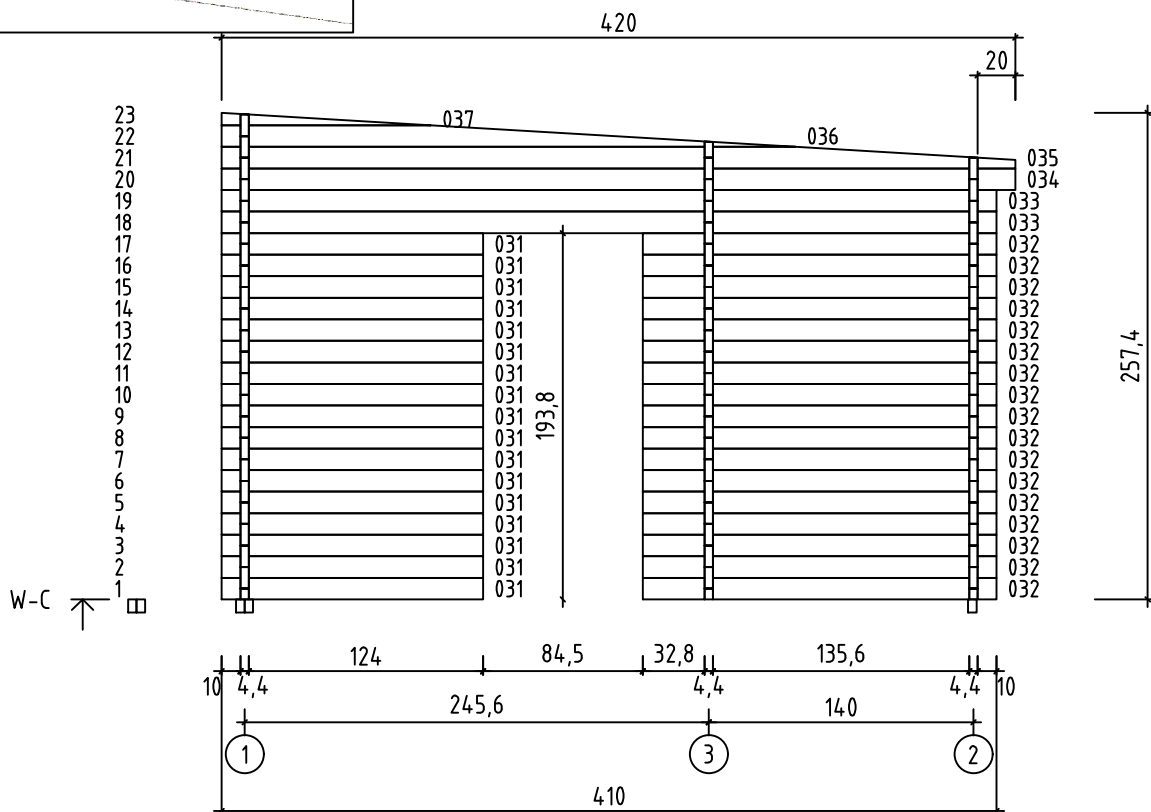
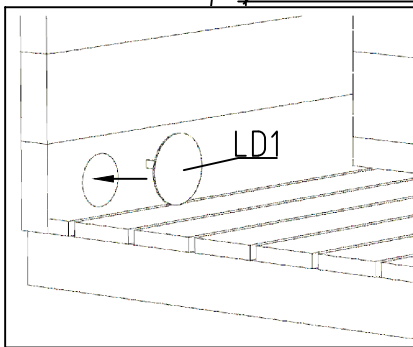
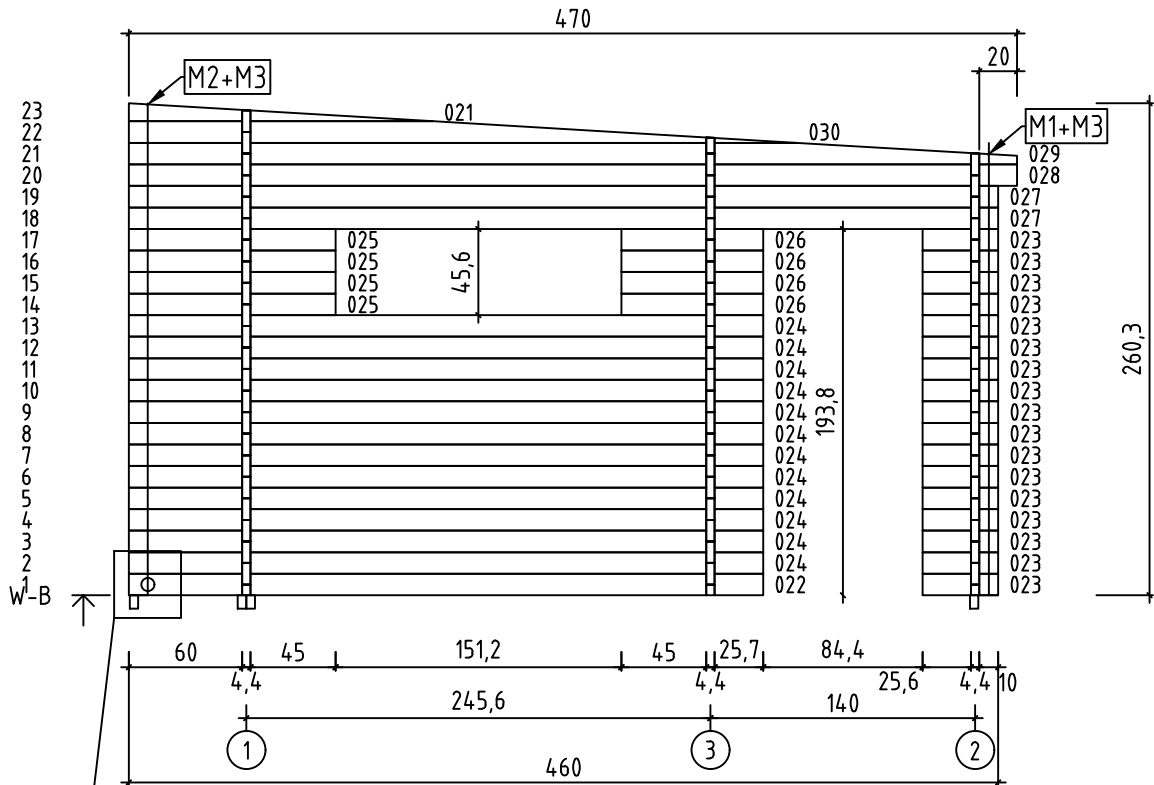

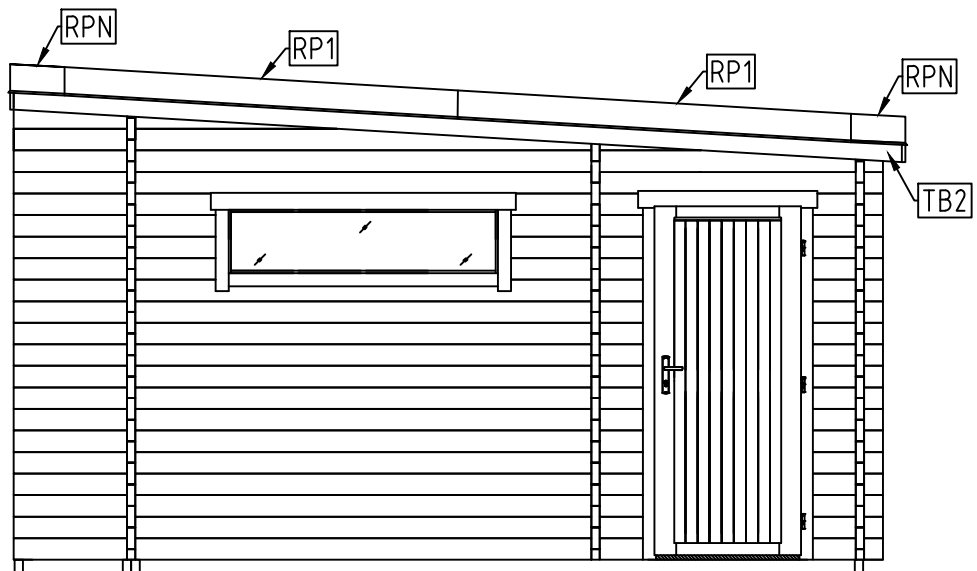
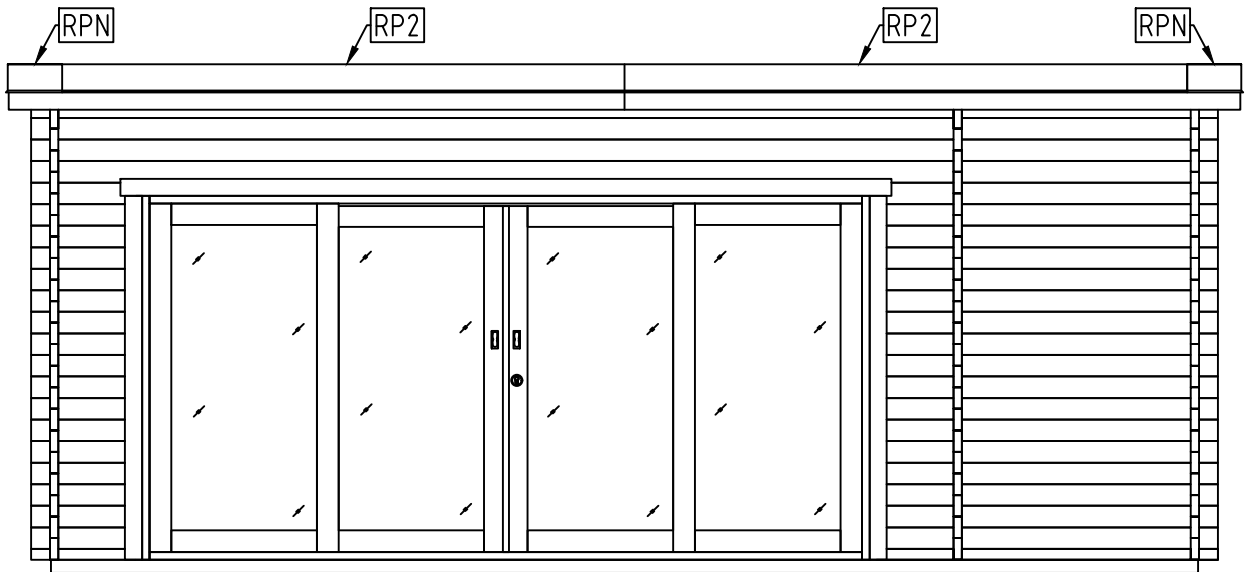



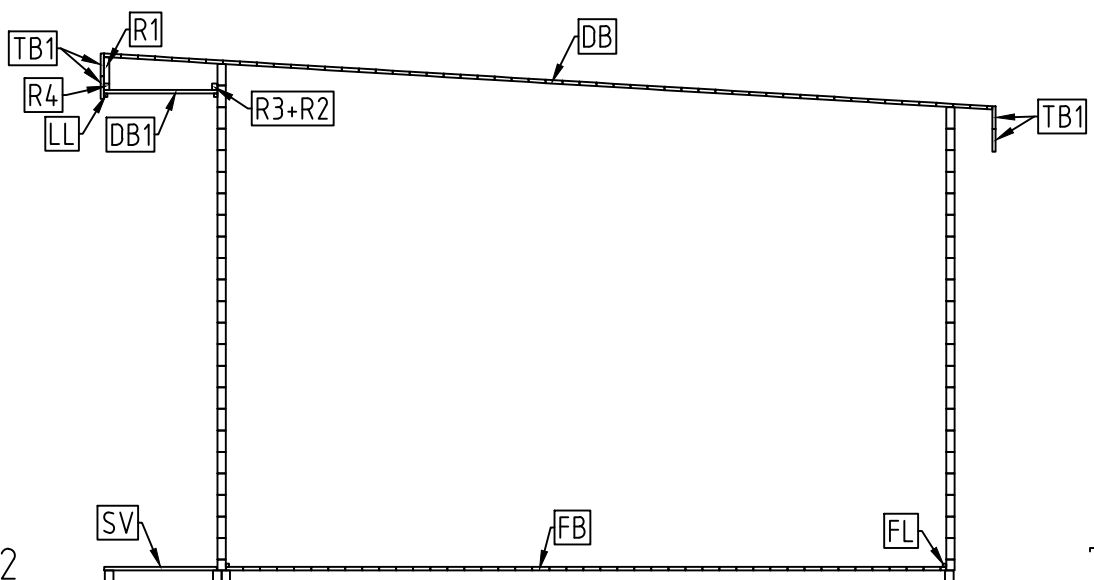

Art. Nr. 4415802

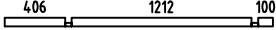

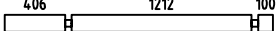
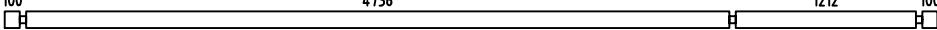
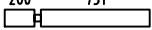
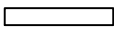
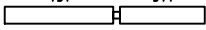
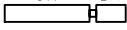
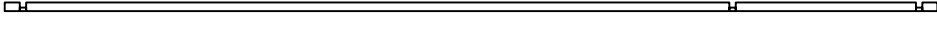

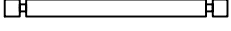
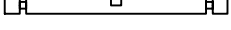
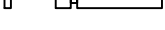

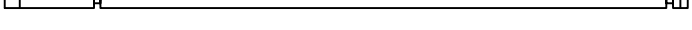
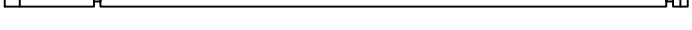
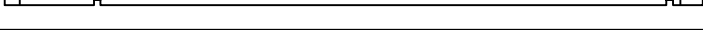
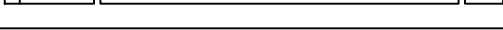

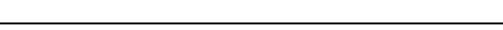
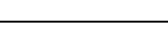
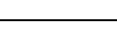
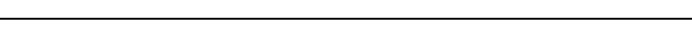
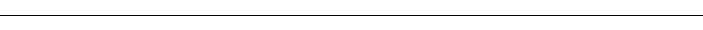



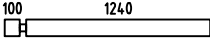
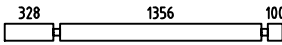
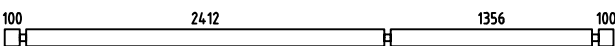
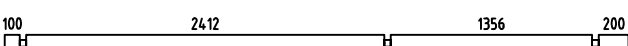
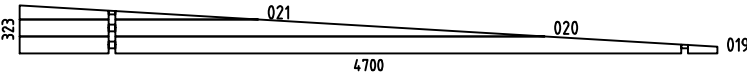
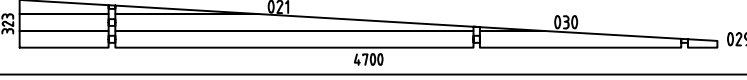
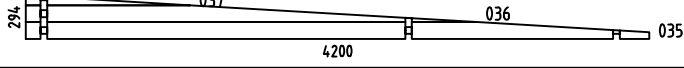
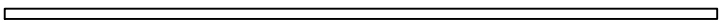

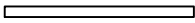

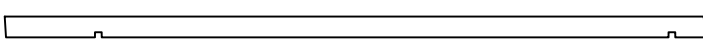

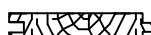



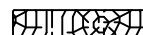



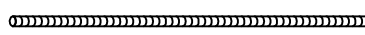





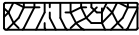
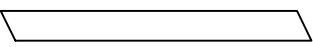





Cross section - Schnitt - Vu de coupe - Sezione trasversale - Doorsnede - Lõige  
A-A

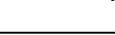
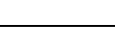
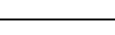

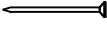
Pos	24.02.2022 Piece list - Stückliste - Liste des pièces - Elementi - Stuklijst - Tükitabel Art. Nr. 4415802	8/11	Q	P (mm)	L (mm)
001			1	44x57	550
002			1	44x57	1806
003			17	44x114	550
004			17	44x114	1806
005			23	44x114	6280
006			2	44x114	975
007			8	44x114	731
008			2	44x114	1346
009			2	44x114	815
010			1	44x57	6280
011			1	44x57	1500
012			19	44x114	1500
013			1	44x114	1500
014			1	44x85	715
015			1	44x85	715
016			1	44x114	4600
017			18	44x114	4600
018			1	44x114	4700
022			1	44x114	3356
023			17	44x114	400
024			12	44x114	3356
025			4	44x114	1094
026			4	44x114	751
027			2	44x114	4600
028			1	44x114	4700

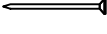
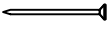
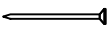
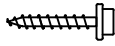

Pos	24.02.2022 Piece list - Stückliste - Liste des pièces - Elementi - Stuklijst - Tükitalabel Art. Nr. 4415802	9/11	Q	P (mm)	L (mm)
031			17	44x114	1384
032			17	44x114	1872
033			2	44x114	4100
034			1	44x114	4200
WA-1			1		
WB-1			1		
WC-1			1		
IAR3	Foundation - Fundament - Fondation - Fondamenta - Fundering - Immutatud alusraam 		4	45x70	4797
IAR2	Foundation - Fundament - Fondation - Fondamenta - Fundering - Immutatud alusraam 		14	45x70	3783
IAR4	Foundation - Fundament - Fondation - Fondamenta - Fundering - Immutatud alusraam 		4	45x70	1273
IAR1	Foundation - Fundament - Fondation - Fondamenta - Fundering - Immutatud alusraam 		3	45x70	527
SR1	Rafter - Dachsparren - Chevron - Trave - Dak spar - Sarikas 		6	70x140	4716
FB	Floor boards - Fussbodenbretter - Lame de plancher - Pavimento - Vloerhout - Põrandalaud 		43	90x18	4732
FB	Floor boards - Fussbodenbretter - Lame de plancher - Pavimento - Vloerhout - Põrandalaud 		43	90x18	1208
DB2	Roof boards - Dachbretter - Voliges - Perlina per tetto - Dakhout - Kafuselaud 		53	90x18	3413
DB3	Roof boards - Dachbretter - Voliges - Perlina per tetto - Dakhout - Kafuselaud 		53	90x18	3067
DB1	Roof boards - Dachbretter - Voliges - Perlina per tetto - Dakhout - Kafuselaud 		67	90x18	596
SV	Terrace boards - Terrassenbretter - Plancher de terrasse - Piattaforme terrazzo - Terrasvloer - Terrassilaud 		64	90x19	596
LL	Ceiling fillet - Deckeleiste - Profil de finition sous plafond - Massello per soffitto - Dak afdeklijst - Laeliist 			18x18	14
FL	Floor fillet - Fussbodenteiste - Corniere de finition du plancher - Finitura per pavimento (battisco pa) - Vloerafwerklijst - Põrandaliist 			18x18	30
M1	Treaded rod m10 - Gewindestange m10 - Tige filetée m10 - Barra filettata passo m10 - Draadstang 10m - Keermelatt 		2		365
M2	Treaded rod m10 - Gewindestange m10 - Tige filetée m10 - Barra filettata passo m10 - Draadstang 10m - Keermelatt 		2		565
M3	Treaded rod m10 - Gewindestange m10 - Tige filetée m10 - Barra filettata passo m10 - Draadstang 10m - Keermelatt 		4		2000
R1	Lath - Pfetten - Liteau - Piccola asse - Gordingen - Roov 		2	28x34	140
R2	Lath - Pfetten - Liteau - Piccola asse - Gordingen - Roov 		2	28x34	570









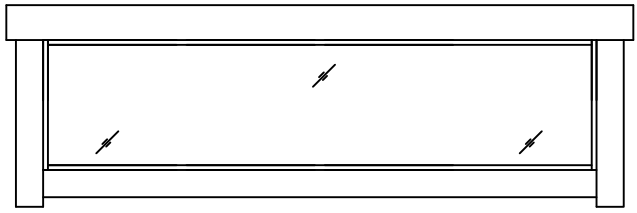

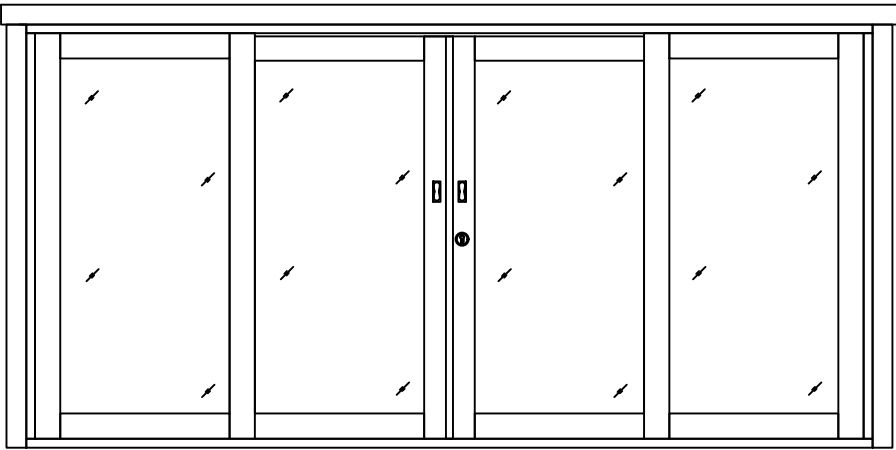
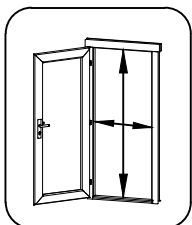

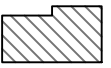

Pos	24.02.2022 Piece list - Stückliste - Liste des pièces - Elementi - Stuklijst - Tükitalabel Art. Nr. 4415802	10/11	Q	P (mm)	L (mm)
R3	Lath - Pfetten - Liteau - Piccola asse - Gordingen - Roov		6	28x34	730
R4	Lath - Pfetten - Liteau - Piccola asse - Gordingen - Roov		2	28x34	2996
TB1	Fascia board - Traufbrett - Bandeau de toit - Finitura lati tetto - Gevellijst - Räästalaud		8	18x120	3258
TB2	Fascia board - Traufbrett - Bandeau de toit - Finitura lati tetto - Gevellijst - Räästalaud		4	18x120	4715
RP1	Fascia sheet - Abschlussprofil - Profil de finition métallique pour débord de toiture - Scossalina di protezione dall'acqua per bordo di legno - Afdek profiel / boordprofiel - Räästaplekk		4		2200
RP2	Fascia sheet - Abschlussprofil - Profil de finition métallique pour débord de toiture - Scossalina di protezione dall'acqua per bordo di legno - Afdek profiel / boordprofiel - Räästaplekk		4		3100
LD1	Lid for treaded rod hole - Abdeckung für gewindestangenöffnung - Couvercle pour accés réglagé tige filetée - Copeerchio per foro barra filettata - Afdekprofiel voor draadstang - Kaas keermelati avale		2		
	Lengthening bolt for treaded rod - Verlängerungsmutter für gewindestange - Manchon de raccordement de tige filetée - Bullone per barra filettata passo - Extensie moer voor draadstang - Keermelati jätlumutter		4	D10	
HS12	Screw for roof lath - Schraube für dachlatte - Vis pour latte - Vite per listello del tetto - Schroef voor daklat - Kruvi roovile		33	4x40	
HS32	Screw for fascia boards - Schrauben für traufbretter - Vis pour fixation bandeau de toit - Viti x striscia del tetto - Schroef voor gevellijst - Kruvi räästalaualle		106	4x40	
HS43	Screw for roof beams - Schrauben für dachbalken - Vis pour fixation pannes de toit - Viti per perline del tetto - Schroef voor gordingen / dakbalken - Kruvi pärlinifele		18	5x120	
HS18	Screw for gable - Schrauben für giebel - Vis pour fixation des pignons - Viti per timpano - Schroef voor gevelpunt - Kruvi viilude kinnitamiseks		18	5x120	
HS40	Screw for 1. wall beam - Schraube für 1. bohlenreihe - Vis de fixations 1ere rangée de madriers avec poutrelles de fondations - Vite fissaggio alle fondamenta - Schroef voor 1 wandbalk - Kruvi poollauale		12	5x90	
HS39	Screw for foundation - Schrauben zur befestigung fundament - Vis de fixations des poutrelles de fondations - Viti x fondamenta - Schroef voor fundering - Kruvi alusraamile		54	5x90	
HS23	Screw for wall details - Schraube für wand details - Vis pour mur details - Viti per elementi della porta - Schroef voor wand details - Kruvi seinadetailidele		68	6x180	
NF2	Zn nail for ceiling fillet - Zn nagel deckeleiste - Pointe pour profil de finition sous plafond - Chiodi zincati per massellini del soffitto - Spijker(nagel) voor plafond afdekljst - Nael laeliistule		27	1.4x40	
NF2	Zn nail for floor fillet - Zn nagel für fussbodenleiste - Pointe pour corniere de finition du plancher - Chiodi x fissaggio pavimento - Spijker(nagel) voor vloer afdekljst - Nael põrandaliistule		60	1.4x40	
SH44	Hammer block - Schlagholz - Calle de frappe - Blocco di legno da usare come cuscinetto quando si usa il martello - Slagklos - Löögiklots		1		
	Drive nut treaded rod - Einshlagmutter für gewindestange - Écrou a frapper pour tige filitée - Dado guida per barra filettata - Aandrijfmoer / aanslagmoer voor draadstang - Löökmutter keermelatile		4	D10	
SFS	Nut for treaded rod - Mutter für gewindestange - Écrou pour tige filetée - Dado per barra filettata - Moer voor draadstang - Mutter keermelatil		4	D10	
NF3	Zn nail for terrace - Zn nagel für terrassenbretter - Pointe pour plancher de terrasse - Chiodo zincato per terrazza - Spijker(nagel) voor terrasvloer - Nael terrassilauale		260	2.1x50	
NF4	Zn nail for roof - Zn nagel für dachbretter - Pointe pour fixation voliges de toit - Chiodi x perline tetto - Spijker(nagel) voor dakhout - Nael katuselauale		888	2x50	
NF4	Zn nail for floor - Zn nagel für fussbodenbretter - Clous pour plancher - Chiodi x perline pavimento - Spijker(nagel) voor vloer - Nael põrandalauale		528	2x50	
	Screw for fascia sheet - Schraube für abschlussprofil - Vis pour profil de finition métallique pour débord de toiture - Viti per fissare i folgi di gronda - Schroef voor afsluit (afdek)profiel - Katusekruvi		56	4.8x28	
RPN	Fascia sheet corner - Eckprofil - Profil d'habillage de rives - Scossalina di protezione dall'acqua per angolo di borbo in legno - Hoekprofiel - Räästapleki nurk		4		

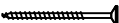
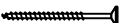
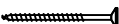

Pos	04.01.2018 Piece list - Stückliste - Liste des pièces - Elementi - Stuklijst - Tükítabel 1500x410 AK.1.100.TPM0.k DGP	1/1	Q	P (mm)	L (mm)
-----	--------------------------------------------------------------------------------------------------------------------------	-----	---	-----------	-----------

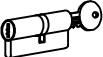
Glass size - Glasgröße - Taille de la vitre - Misura del vetro - Glas afmeting - Klaasi mõõt: 1420x330 mm



Pos	Piece list - Stückliste - Liste des pièces - Elementi - Stuklijst - Tükítabel 04.02.2018 3914x1957 TUK.1.100.TPLP.MMf DGP	1/1	Q	P (mm)	L (mm)
	<p>Glass size - Glasgröße - Taille de la vitre - Misura del vetro - Glas afmeting - Klaasi mõõt: 786x1616 mm  Glass size - Glasgröße - Taille de la vitre - Misura del vetro - Glas afmeting - Klaasi mõõt: 786x1631 mm</p>   <p>1770x1845</p>				
1	Upper door jamb - Türrahmen oben - Cadre de porte supérieur - Telaio superiore della porta - Bovendorpel - Ukse ülemine leng		1	89x130	4080
2	Left door jamb - Türrahmen links - Cadre de porte gauche - Telaio montante sinistro della porta - Linkerstijl deurframe - Ukse vasak leng		1	89x130	1925
3	Right door jamb - Türrahmen rechts - Cadre de porte droit - Telaio montante destro della porta - Rechterstijl deurframe - Ukse parem leng		1	89x130	1925
4	Doorstep - Swelle - Barre de seuil - Soglia della porta - Deurdorpel - Lävepak		1	89x40	3850
7	Connection strip - Deckleiste - Baguette de battement - Profilo verticale della porta - Stulpilijst - Kokkuvaltsiliist		1	18x32	1830
HS5	Screw for lock covers - Schraube für schlossblenden - Vis pour set de garnitures de serrure de porte - Viti per copriserratura - Schroef voor sluitplaat slot - Kruvi lükandukse lukuplaadile		4	2.5x16	
HS4	Screw for door handle fittings - Schraube für türgriff - Vis pour fixation poignée de porte - Viti per montaggio delle maniglie - Schroef voor deurgreep (hendel) - Kruvi lükandukse käepidemele		16	3x30	
HS4	Screw for sliding door roller - Schraube für schiebetür laufrad - Vis pour ferrure de porte coulissante - Viti per rullo delle porte scorrevoli - Schroef voor schuifdeur wiel-katrol - Kruvi lükandukse ülemisele juhikule		8	3x30	
HS4	Screw for door fillet - Schraube zur befestigung türleiste - Vis pour fixation baguette d'arret de porte - Viti per massellino della porta - Schroef voor deurlijst - Kruvi ukse kokkuvaltsiliistule		5	3x30	
HS2	Screw for door jamb - Schraube für türrahmen - Vis de fixation partie haute avec montants du cadre de porte - Viti x fissaggio montanti porte - Schroef voor deurkozijn - Kruvi ukse lengile		4	5x120	
HS1	Screw for door jamb - Schraube für türrahmen - Vis de fixation partie haute avec montants du cadre de porte - Viti x fissaggio montanti porte - Schroef voor deurkozijn - Kruvi ukse lengile		4	5x90	
HS3	Screw for door jamb - Schraube für türrahmen - Vis de fixation partie haute avec montants du cadre de porte - Viti x fissaggio montanti porte - Schroef voor deurkozijn - Kruvi ukse lengile		16	5x90	
	Handle for sliding door - Muschel für schiebetür - Poignée couvette - Maniglia per porta scorrevole - Handvat / klink schuifdeur - Lükandukse käepide		4		
	Cylinder - Zylinderschloss - Barillet de porte - Cilindro (solito diserratura) - Cylinder - Lükandukse lukusüdamik		1		
LF	Roller for sliding door - Laufrad für schiebetür - Ferrure pour porte coulissante - Rullo per porta scorrevole - Wielkatrol voor schuifdeur - Lükandukse ülemine juhik		4		
	Set of door lock covers - Schlossblenden - Set de garnitures de porte - Copertura serrature - Slot sluitplaat set - Lükandukse ümar lukuplaat		2		
	Striker for barrel bolt - Hülse für grendelriegel - Gache au sol du targette - Boccola per fermo della porta - Huls voor vergrendelingsschuif - Vasturaud ukse servariivile		2		

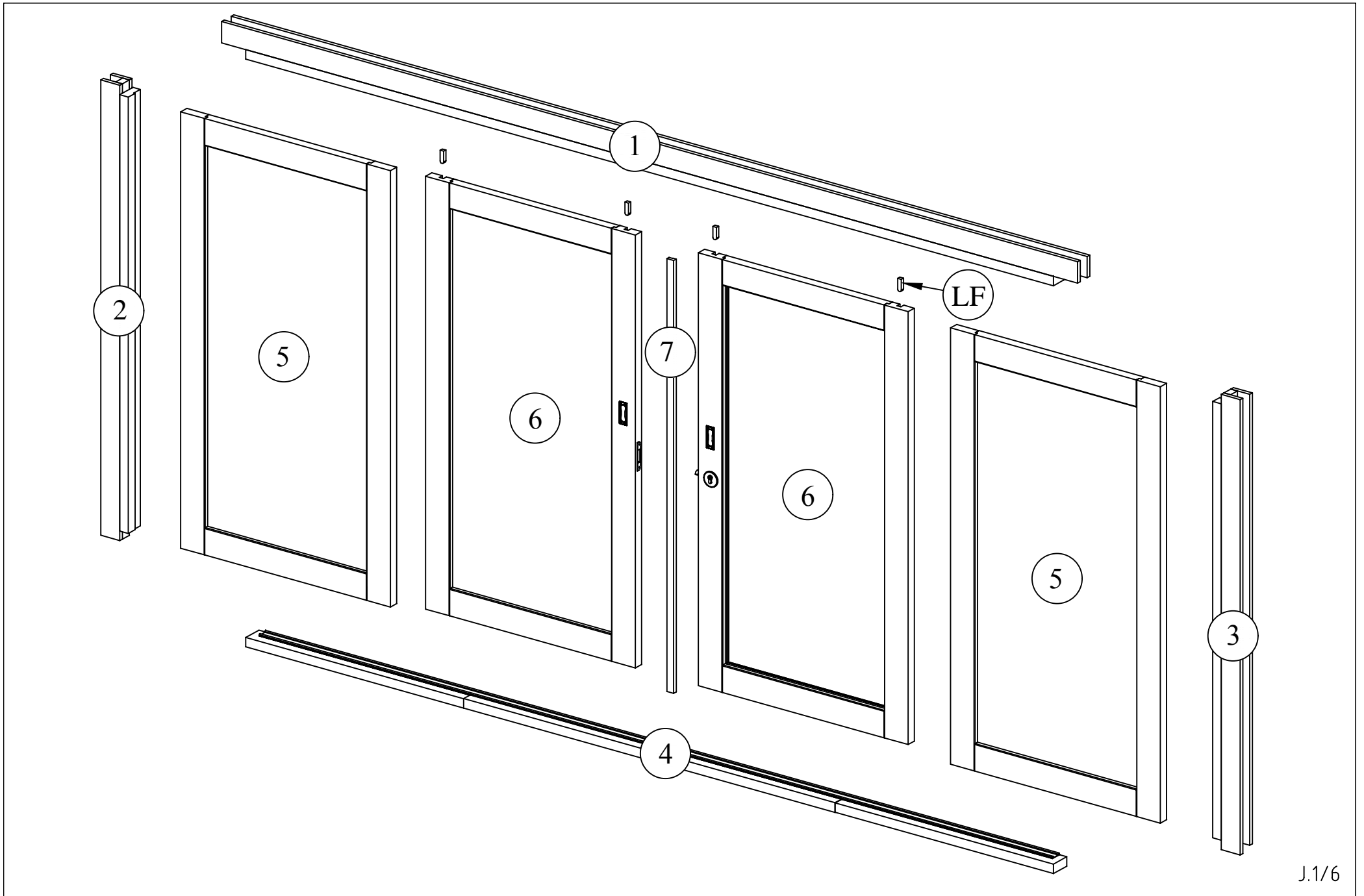

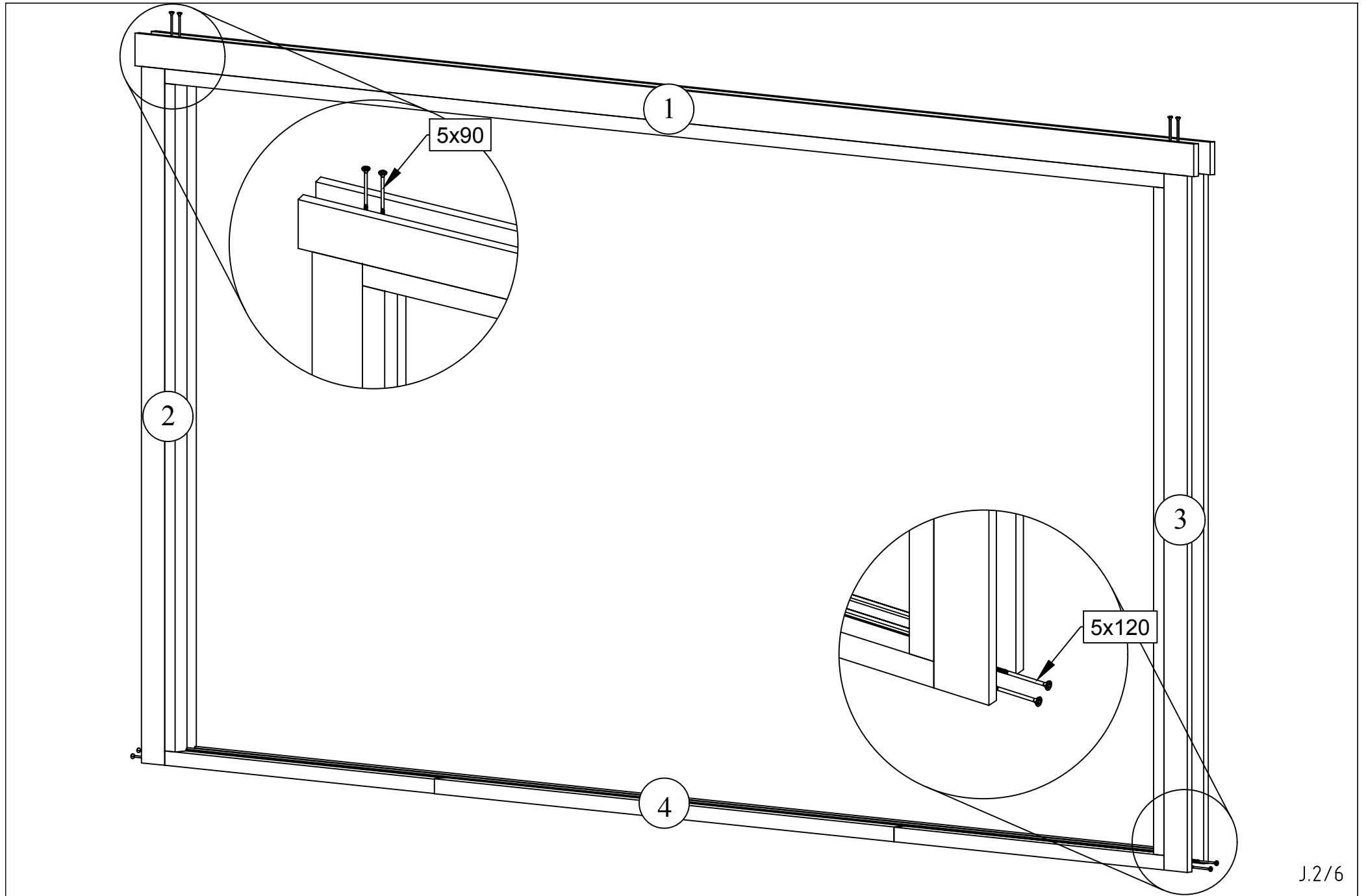

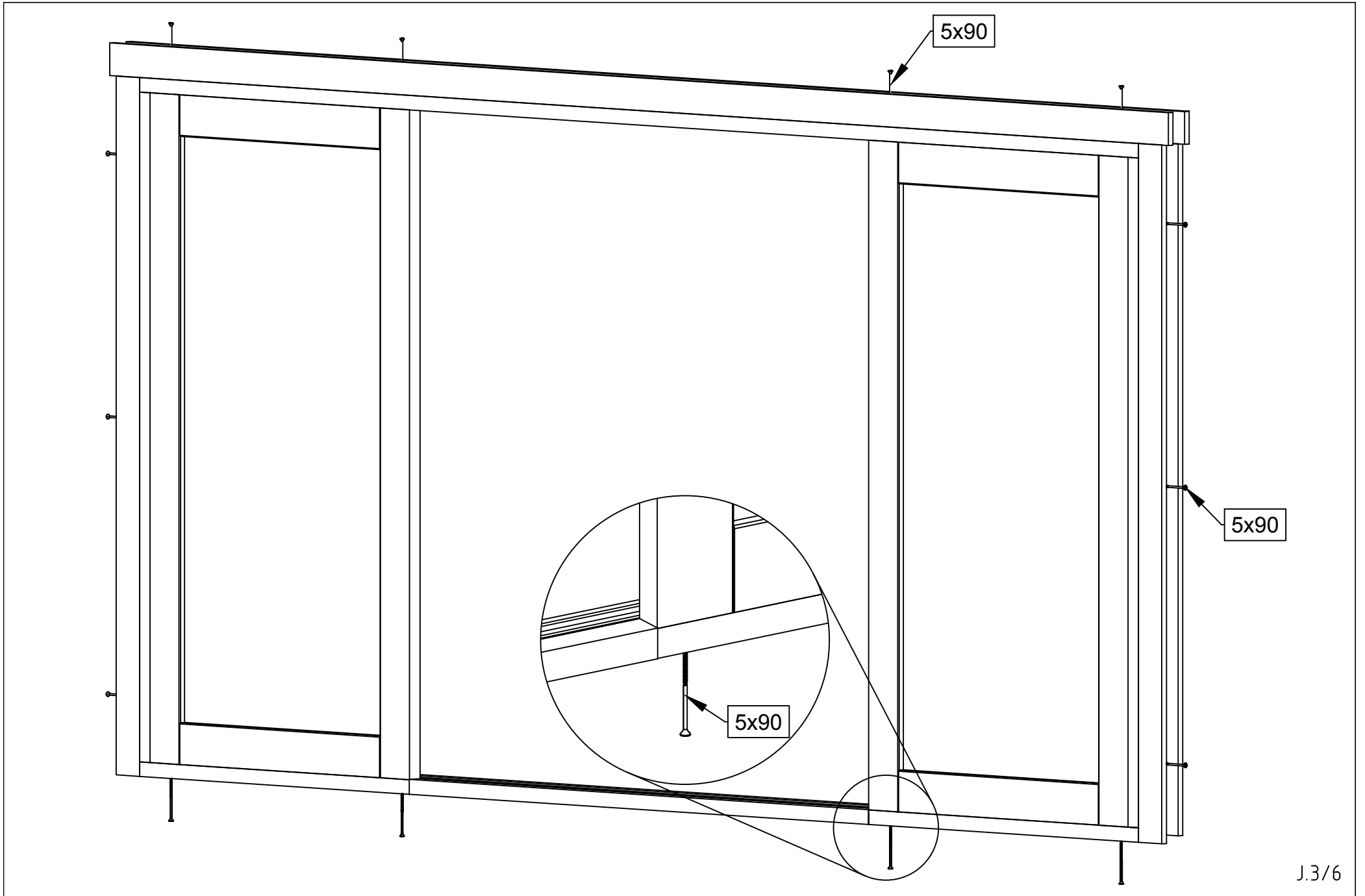



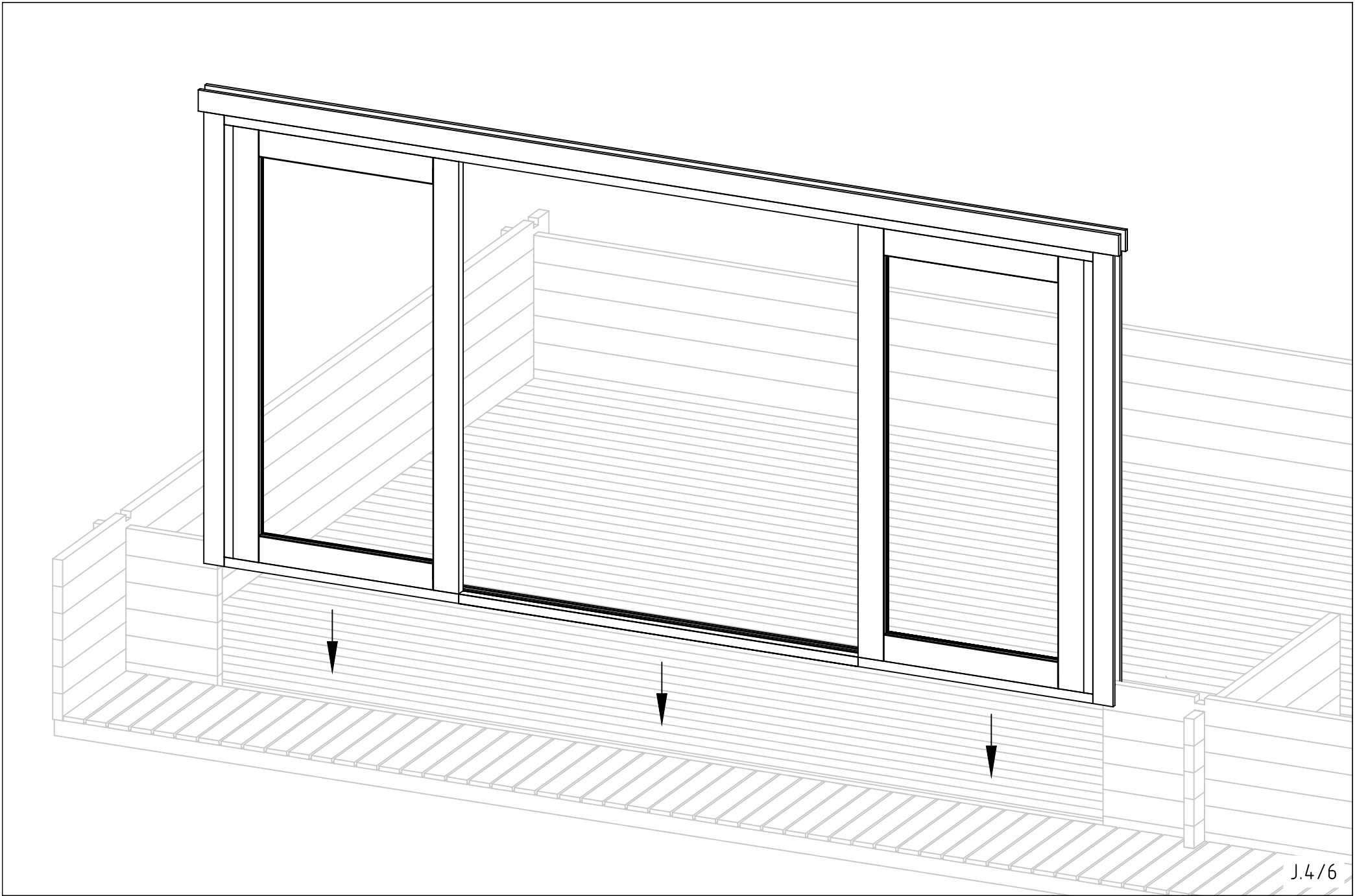

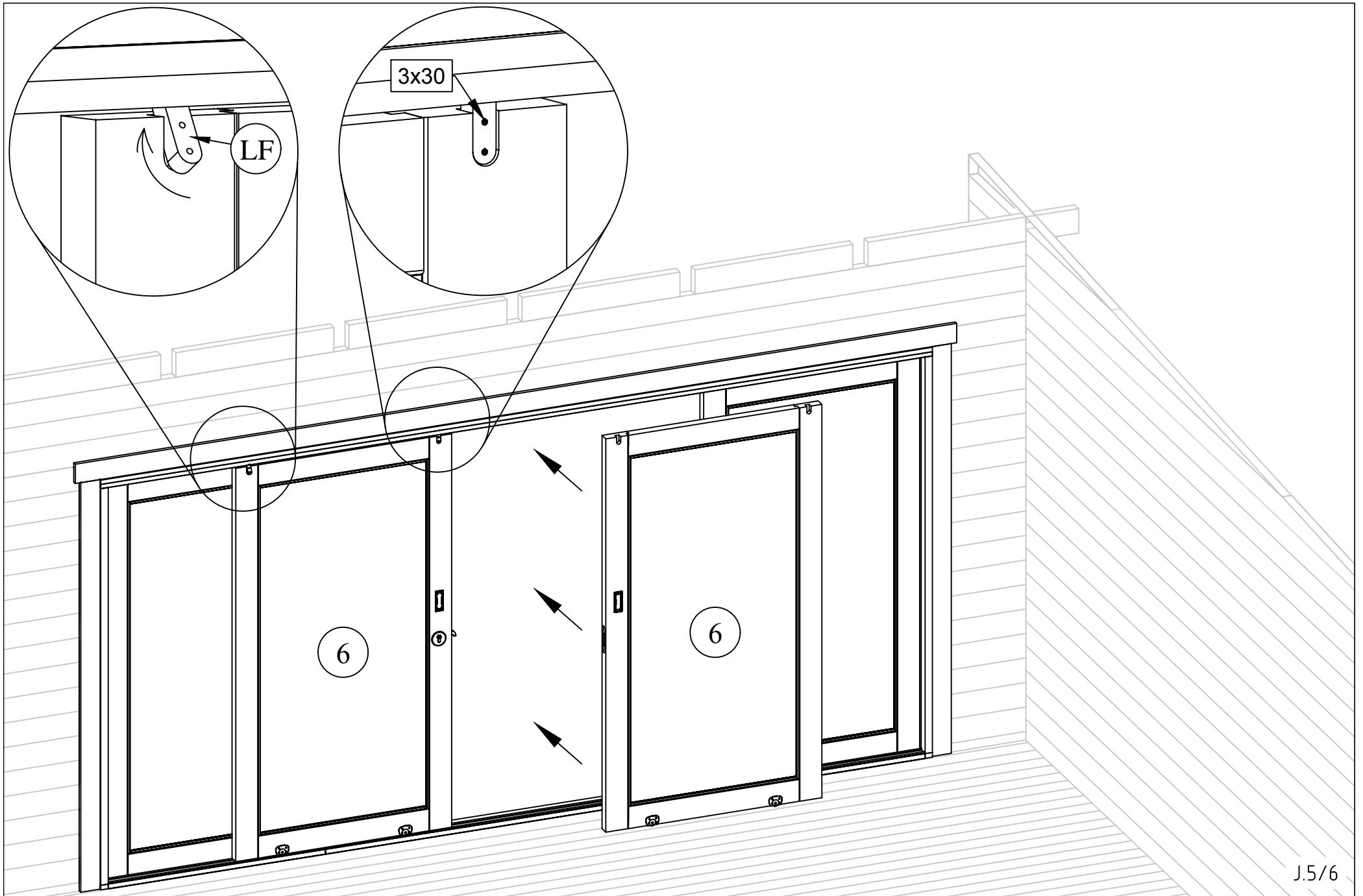

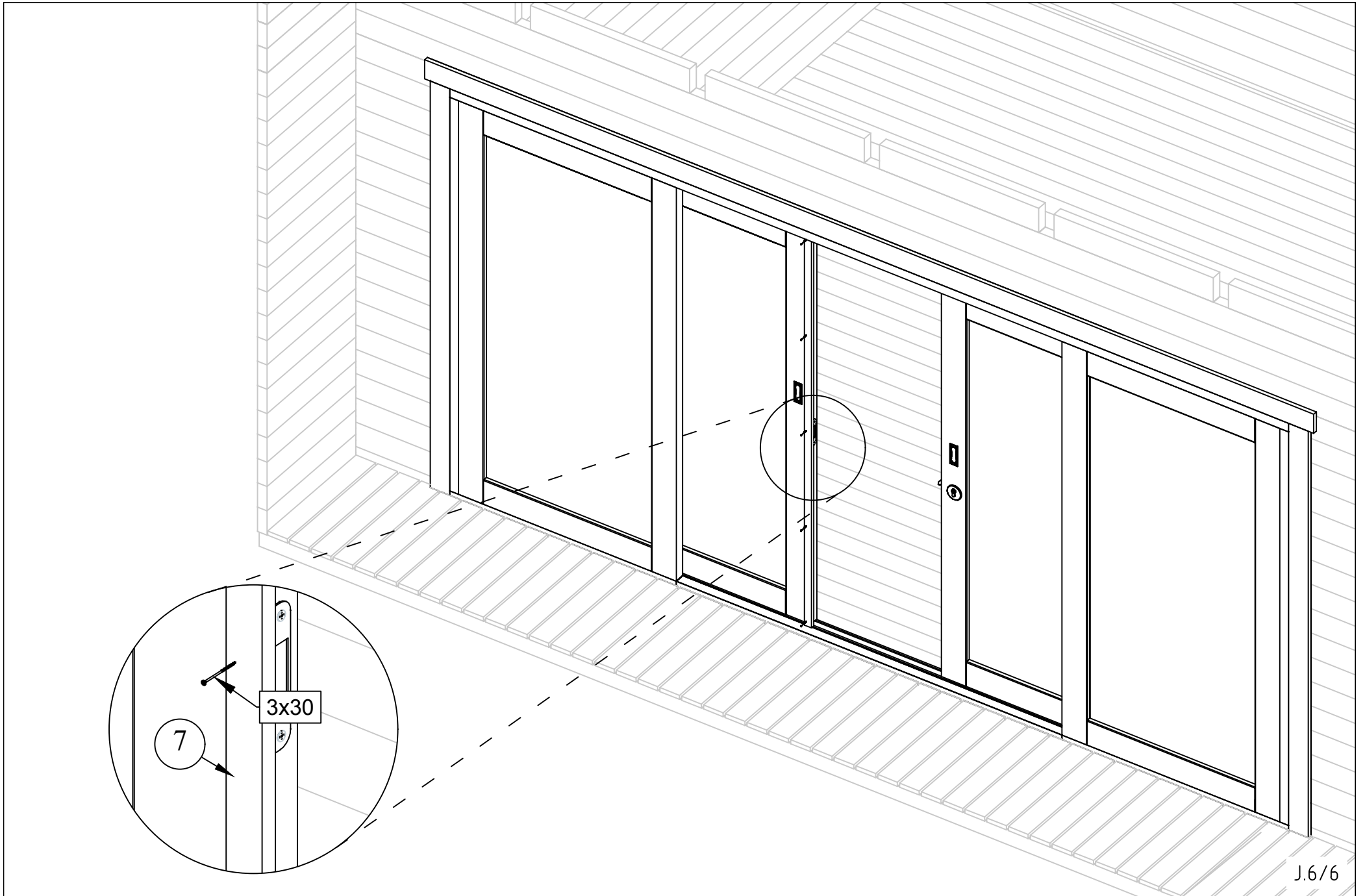

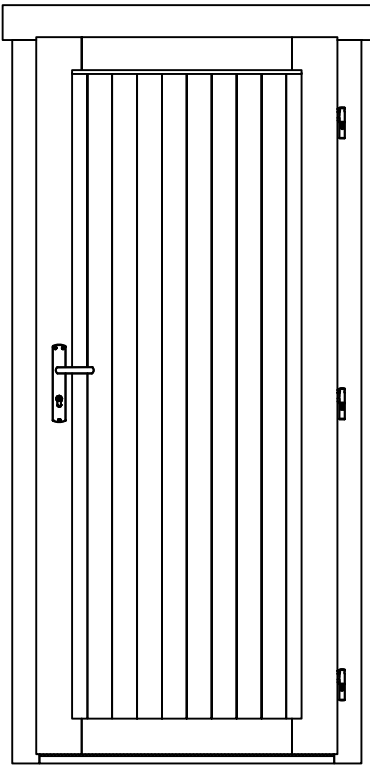
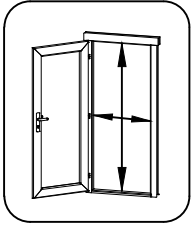
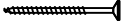

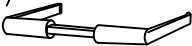

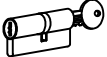



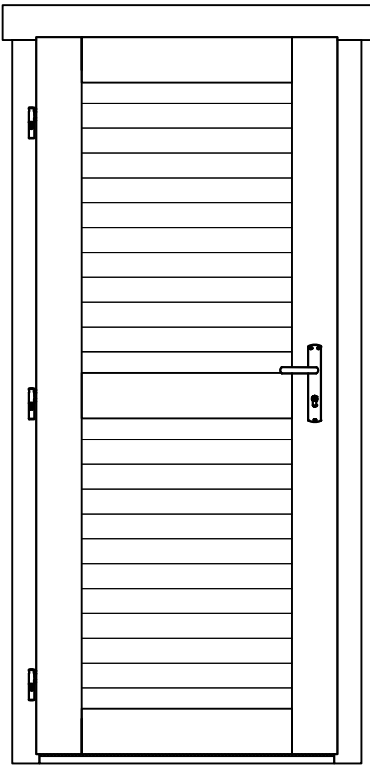
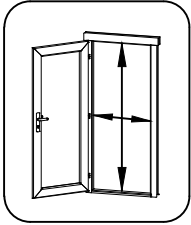

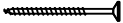
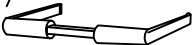

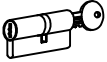
Pos	12.05.2016	Piece list - Stückliste - Liste des pièces - Elementi - Stuklijst - Tükítabel 835x1900 UL.2.100.IVP.MMWd TP+	1/1	Q	P (mm)	L (mm)
		  <p>735x1818 mm</p>				
HS16	Screw for door jamb - Schraube für Türrahmen - Vis de fixation partie haute avec montants du cadre de porte - Viti x fissaggio montanti porte - Schroef voor deurkozijn - Kruvi ukse lengile		4	5x90		
HS25	Screw for doorstep - Schrauben für swelle - Vis pour fixation barre de seuil - Vite per soglia della porta - Schroef voor deurdorpel - Kruvi lävepakule		2	4.5x65		
TL4	Door handle fittings - Türgriff - Poignée de porte - Maniglie - Deurhendel / klink - Ukse käepide VU		1			
TL5	Set of door lock covers - Schlossblenden - Set de garnitures de porte - Copertura serrature - Slot sluitplaat set - Ukse lukuplaat		1			
	Cylinder lock - Zylinderschloss - Barillet de porte - Serratura - Cylinder slot - Ukse lukusüdamik		1	30x35		
	Male bolt hinge for door - Türband - Partie male de paumelle de porte - Cerniera anube x porta - Scharnier bout - Ukse polthing isane		3			
HC	Covers for door hinges - Schutzkappe für Türband - Couverture de paumelle de porte - Copertura delle cerniere della porta - Afdek kap voor deurscharnier - Reguleeritava polthinge kate		6			

Pos	12.05.2016	Piece list - Stückliste - Liste des pièces - Elementi - Stuklijst - Tükítabel 835x1900 UL.2.100.IVV.MMd TP+	1/1	Q	P (mm)	L (mm)
						
						 735x1818 mm
HS16	Screw for door jamb - Schraube für Türrahmen - Vis de fixation partie haute avec montants du cadre de porte - Viti x fissaggio montanti porte - Schroef voor deurkozijn - Kruvi ukse lengile		4	5x90		
HS25	Screw for doorstep - Schrauben für swelle - Vis pour fixation barre de seuil - Vite per soglia della porta - Schroef voor deurdorpel - Kruvi lävepakule		2	4.5x65		
TL4	Door handle fittings - Türgriff - Poignée de porte - Maniglie - Deurhendel / klink - Ukse käepide VU		1			
TL5	Set of door lock covers - Schlossblenden - Set de garnitures de porte - Copertura serrature - Slot sluitplaat set - Ukse lukuplaat		1			
	Cylinder lock - Zylinderschloss - Barillet de porte - Serratura - Cylinder slot - Ukse lukusüdamik		1	30x35		
	Male bolt hinge for door - Türband - Partie male de paumelle de porte - Cerniera anube x porta - Scharnier bout - Ukse polthing isane		3			