

Sundborn
Art. Nr. 4428402
1/10

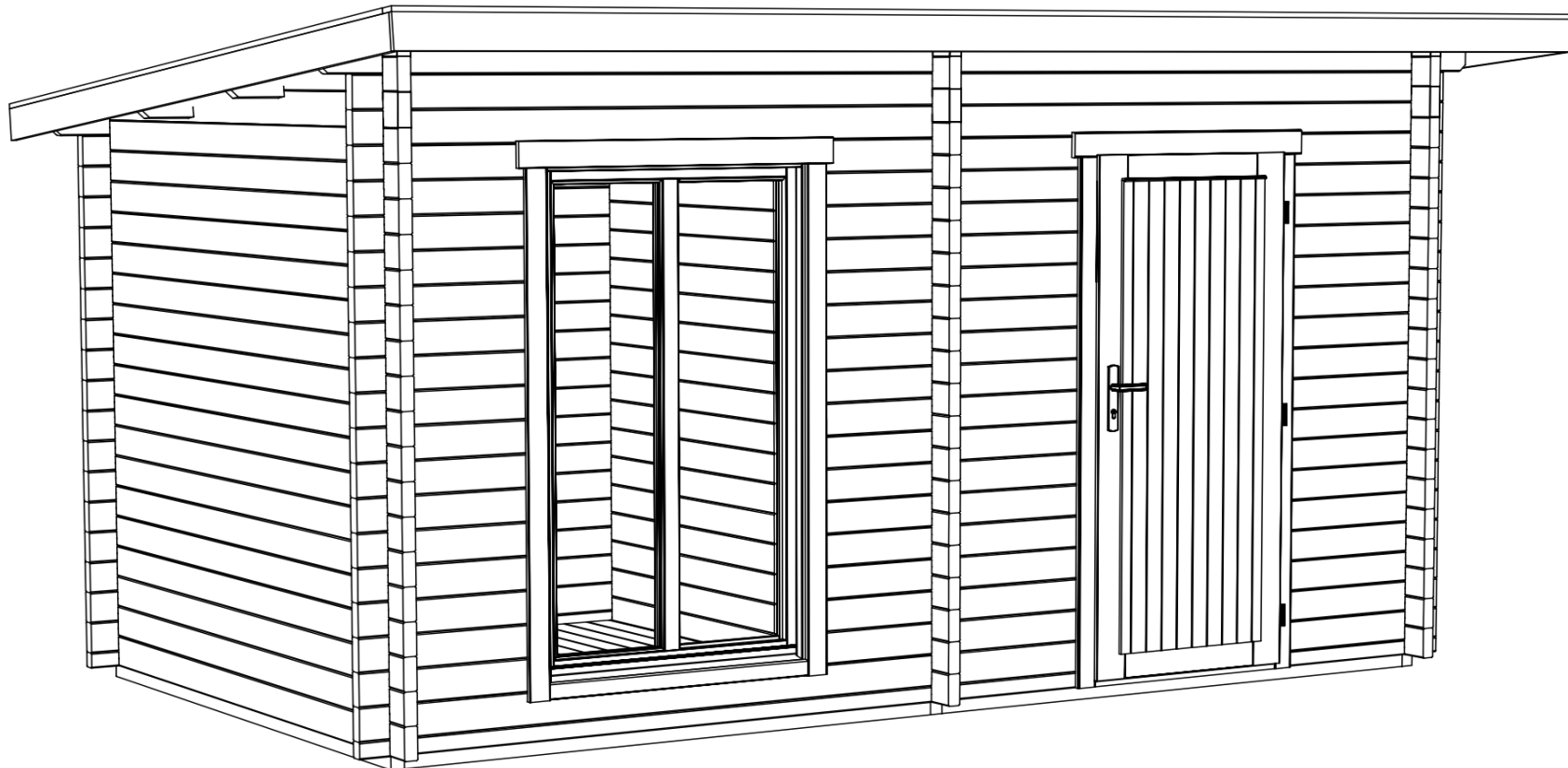

Groundplan - Grundplan - Plan de masse -
Planimetria - Plattegrond - Põhiplaan

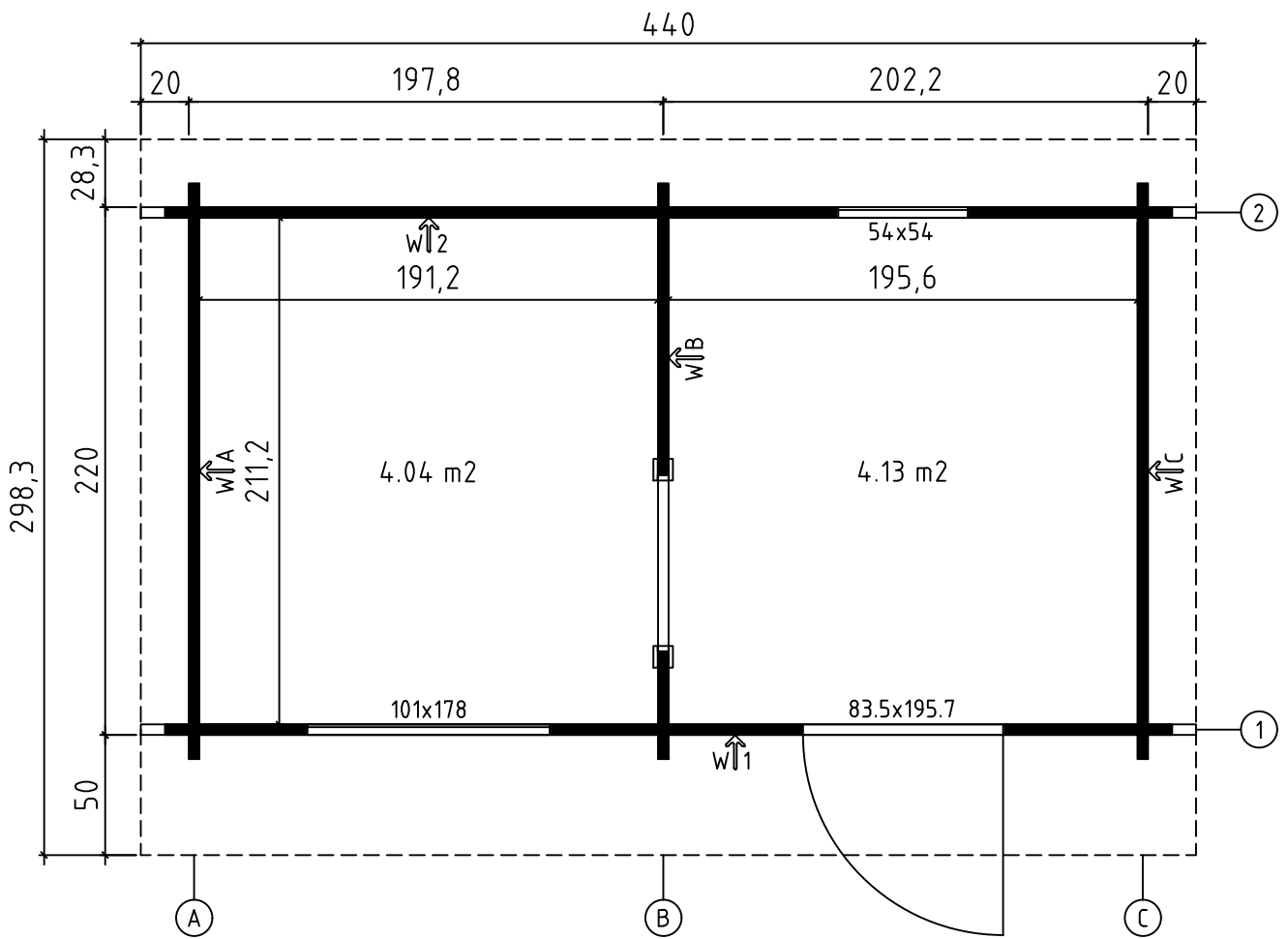

Foundation - Fundament - Fondation -
Fondamenta - Fundering - Immutatud alusraam

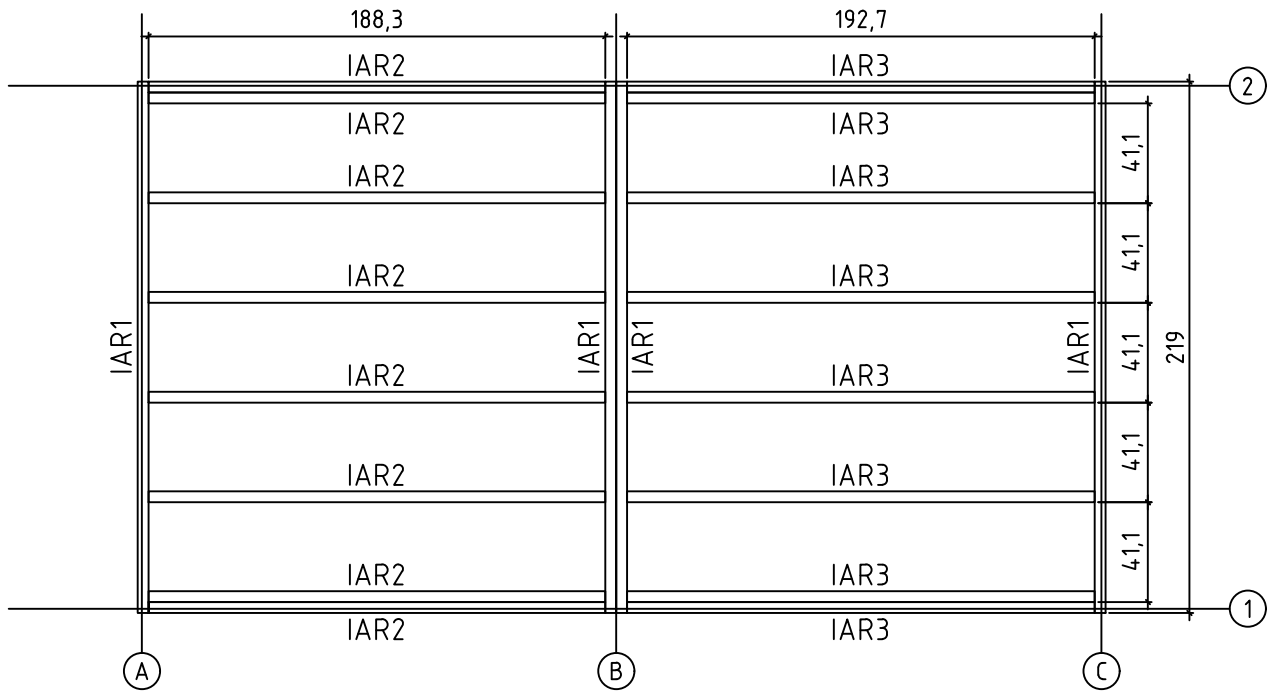

Floor boards - Fussbodenbretter - Plan pose
plancher - Pavimento - Vloerhout - Põrandalaudis

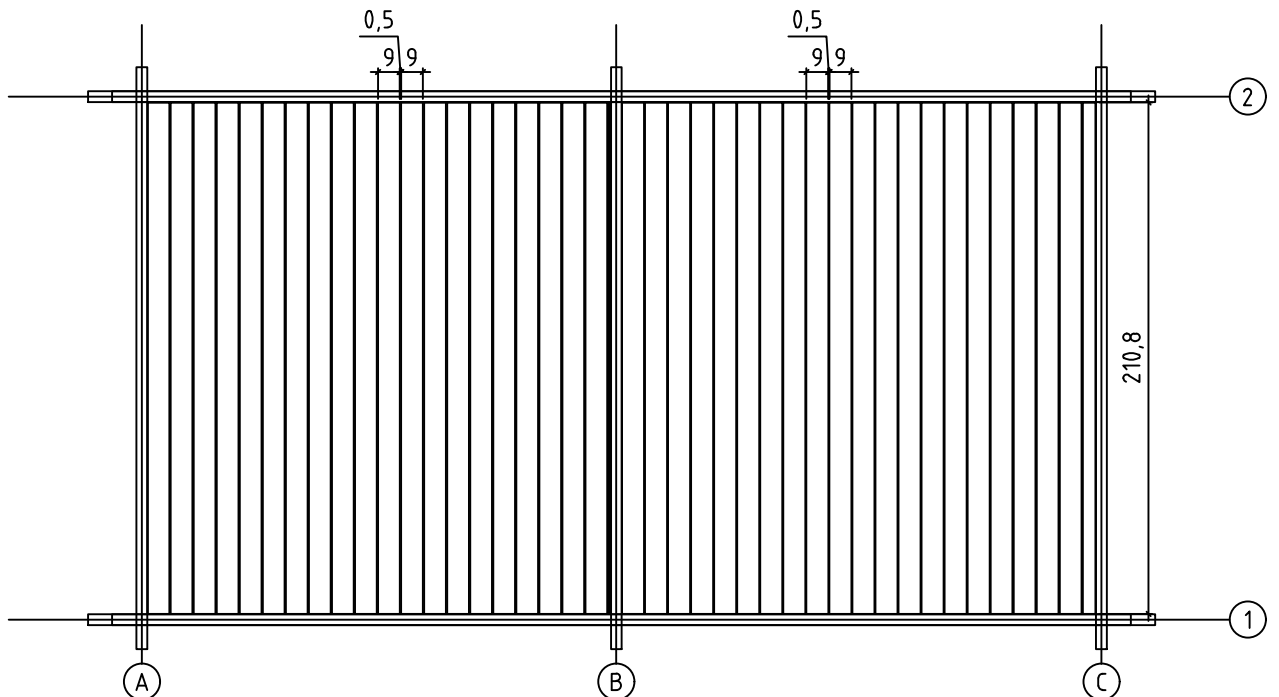



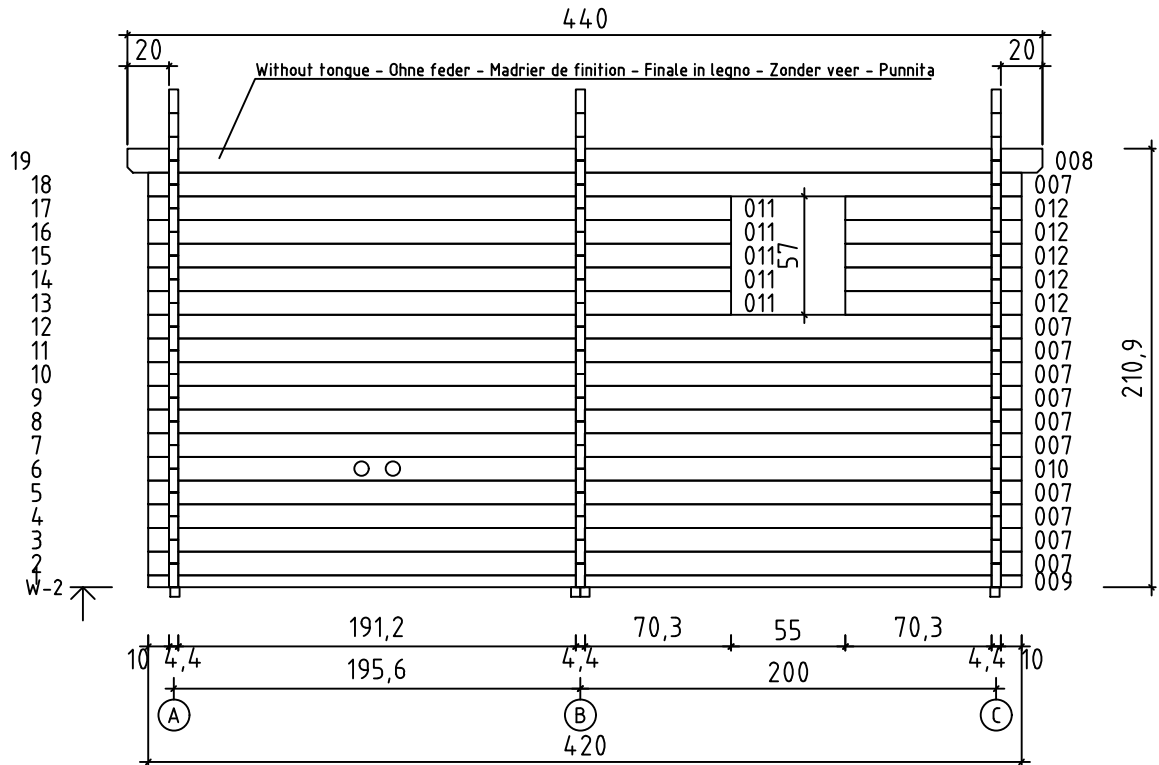
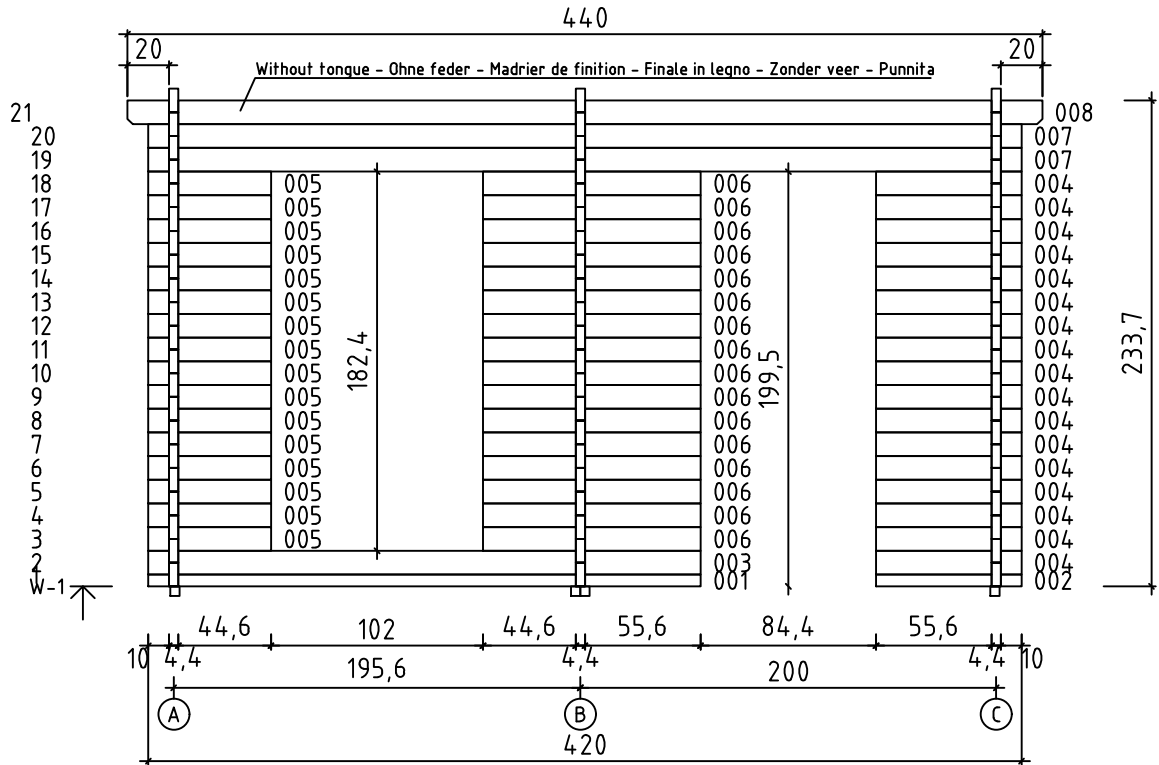



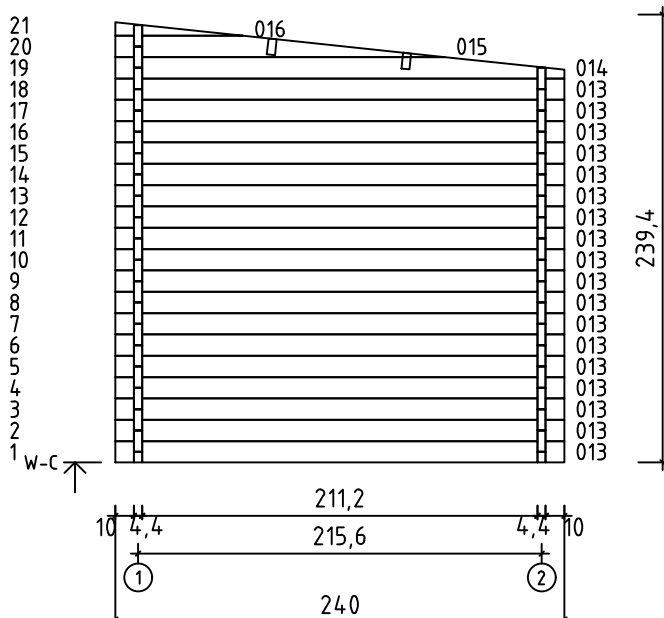
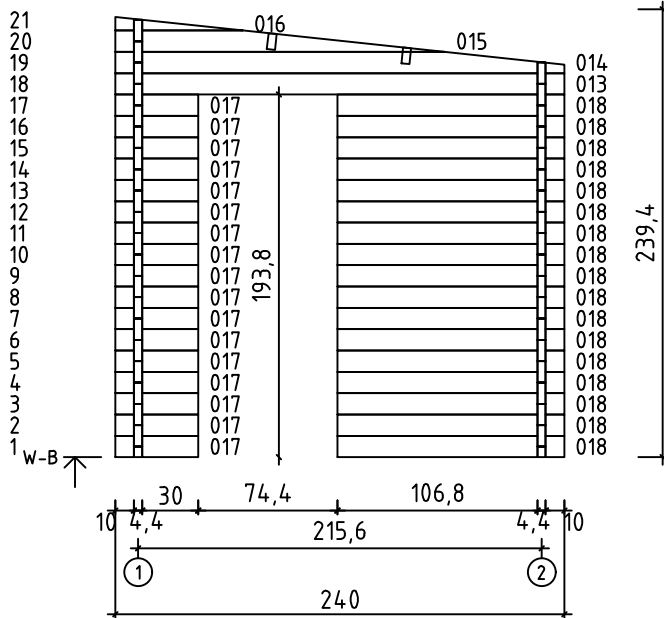
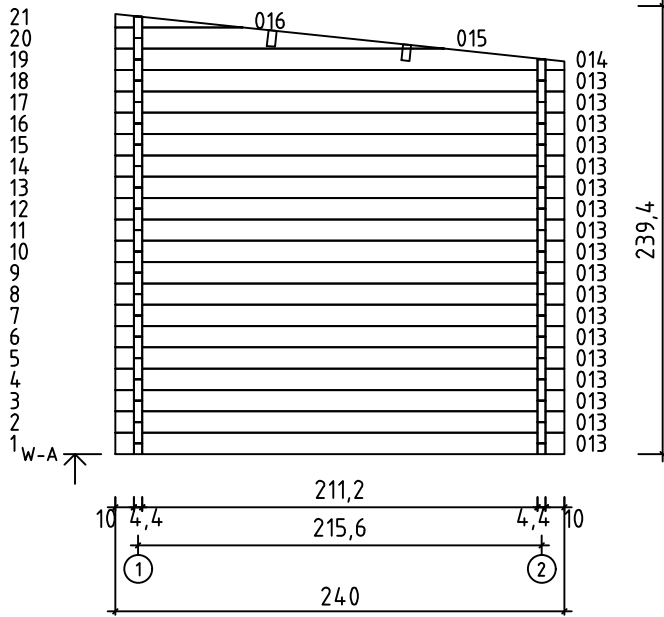

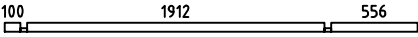
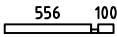
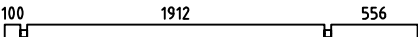
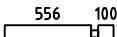

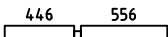
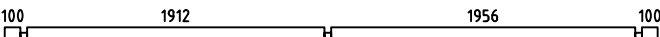
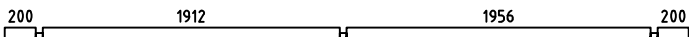

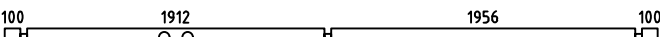
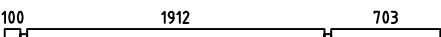
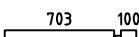
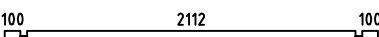
Art. Nr. 4428402

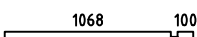
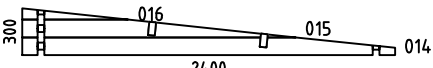
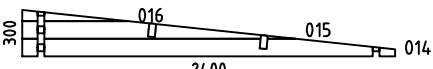
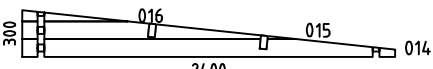

Art. №. 4428402

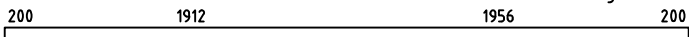

| Pos | 22.02.2022 Piece list - Stückliste - Liste des pièces - Elementi - Stuklijst - Tükitalabel Art. Nr. 4428402 6/10 | Q | P (mm) | L (mm) |
|-------|---|------|-----------|-----------|
| 001 |  | 1 | 44x57 | 2656 |
| 002 |  | 1 | 44x57 | 700 |
| 003 |  | 1 | 44x114 | 2656 |
| 004 |  | 17 | 44x114 | 700 |
| 005 |  | 16 | 44x114 | 590 |
| 006 |  | 16 | 44x114 | 1046 |
| 007 |  | 13 | 44x114 | 4200 |
| 008 |  | 2 | 44x114 | 4400 |
| 009 |  | 1 | 44x57 | 4200 |
| 010 |  | 1 | 44x114 | 4200 |
| 011 |  | 5 | 44x114 | 2803 |
| 012 |  | 5 | 44x114 | 847 |
| 013 |  | 37 | 44x114 | 2400 |
| 017 |  | 17 | 44x114 | 444 |
| 018 |  | 17 | 44x114 | 1212 |
| WA-1 |  | 1 | | |
| WB-1 |  | 1 | | |
| WC-1 |  | 1 | | |
| IAR1 | Foundation - Fundament - Fondation - Fondamenta - Fundering - Immutatud alusraam  | 4 | 45x45 | 2190 |
| IAR3 | Foundation - Fundament - Fondation - Fondamenta - Fundering - Immutatud alusraam  | 8 | 45x45 | 1927 |
| IAR2 | Foundation - Fundament - Fondation - Fondamenta - Fundering - Immutatud alusraam  | 8 | 45x45 | 1883 |
| A-PR1 | Roof beam - Dachbalken - Panne de toit - Perlina del tetto - Gordingen / dakbalk - Pärilin  | 2 | 44x120 | 4400 |
| | Terrace boards - Terrassenbretter - Plancher de terrasse - Piattaforme terrazzo - Terrasvloer - Terrassilaud  | 42+2 | 90x19 | 2108 |

| Pos | 22.02.2022 Piece list - Stückliste - Liste des pièces - Elementi - Stuklijst - Tükítabel Art. Nr. 4428402 7/10 | Q | P (mm) | L (mm) |
|-------|--|----|-----------|-----------|
| | Roof boards - Dachbretter - Voliges - Perlina per tetto - Dakhout - Katuselaud  | 49 | 90x18 | 3000 |
| | Roofing felt fillet - Dachpappenleiste - Baguette de fixation du feutre bitumeux - Asse per fissaggio guaina bituminosa - Afdeklijst asfaltpapier - Katusepapiiist  | 2 | 18x58 | 3010 |
| | Roofing felt fillet - Dachpappenleiste - Baguette de fixation du feutre bitumeux - Asse per fissaggio guaina bituminosa - Afdeklijst asfaltpapier - Katusepapiiist  | 1 | 18x58 | 4436 |
| RS1 | Corner fillet - Deckleiste - Profils de finition angles a l'exterieur - Massello d'angolo - (hoek)lijst - Nurgaliist  | 2 | 15x45 | 200 |
| RS2 | Corner fillet - Deckleiste - Profils de finition angles a l'exterieur - Massello d'angolo - (hoek)lijst - Nurgaliist  | 2 | 15x45 | 350 |
| RS3 | Corner fillet - Deckleiste - Profils de finition angles a l'exterieur - Massello d'angolo - (hoek)lijst - Nurgaliist  | 2 | 18x90 | 350 |
| DL1 | Railing strip - Begrenzungsleiste - Rembarde - Sbarra - Afscheidingslijst - Piirdelaud  | 2 | 18x90 | 920 |
| DL2 | Railing strip - Begrenzungsleiste - Rembarde - Sbarra - Afscheidingslijst - Piirdelaud  | 4 | 18x90 | 1890 |
| | Fascia board - Traufbrett - Bandeau de toit - Finitura lati tetto - Gevellijst - Räästalaud  | 2 | 18x120 | 3050 |
| | Fascia board - Traufbrett - Bandeau de toit - Finitura lati tetto - Gevellijst - Räästalaud  | 1 | 18x120 | 4436 |
| TB-1 | Fascia board - Traufbrett - Bandeau de toit - Finitura lati tetto - Gevellijst - Räästalaud  | 1 | 18x58 | 4400 |
| DRV-1 | Roof edge reinforcement - Dachrandverstärkung - Corniere de renfort de bord de toit - Rinforzo x tetto - Dakrand versterking - Räästatugevdus  | 2 | 28x34 | 4400 |
| KFS-1 | Storm protection - Sturmleiste - Latte anti-tempete - Protezione anti vento - Stormverankering / beveiliging - Tormikinnitusliist  | 6 | 22x45 | 2050 |
| FF1 | Fixing fillet - Fixierungsleiste - Profil de fixation - Massello di fissaggio - Bevestiging lijstwerk - Tenderliist  | 1 | 22x45 | 734 |
| FF2 | Fixing fillet - Fixierungsleiste - Profil de fixation - Massello di fissaggio - Bevestiging lijstwerk - Tenderliist  | 2 | 22x45 | 1890 |
| HS9 | Screw for covering moulding - Schrauben für deckungsprofil - Vis de fixation profils horizontaux haut inférieur et extérieur d'encadrement de porte - Vite per cornice di copertura - Schroef voor afdekprofiel - Kruvi piirdelauale  | 4 | 3.5x50 | |
| HS12 | Screw for covering moulding - Schrauben für deckungsprofil - Vis de fixation profils horizontaux haut inférieur et extérieur d'encadrement de porte - Vite per cornice di copertura - Schroef voor afdekprofiel - Kruvi piirdelauale  | 32 | 4x40 | |
| HS12 | Screw for fascia boards - Schrauben für traufbretter - Vis pour fixation bandeau de toit - Viti x striscia del tetto - Schroef voor gevellijst - Kruvi räästalauale  | 36 | 4x40 | |
| HS12 | Screw for roof edge reinforcement - Schrauben für dachrandverstärkung - Vis pour fixation corniere renfort de bord de toit - Viti x rinforzo bordo tetto - Schroef voor dakrand versterking - Kruvi räästatugevdusele  | 20 | 4x40 | |
| HS18 | Screw for roof beams - Schrauben für dachbalken - Vis pour fixation pannes de toit - Viti per perline del tetto - Schroef voor gordingen / dakbalken - Kruvi pärlinitele  | 6 | 5x120 | |
| HS18 | Screw for gable - Schrauben für giebel - Vis pour fixation des pignons - Viti per timpano - Schroef voor gevelpunt - Kruvi viilude kinnitamiseks  | 6 | 5x120 | |
| HS16 | Screw for 1. wall beam - Schraube für 1. bohlenreihe - Vis de fixations 1ere rangée de madriers avec poutrelles de fondations - Vite fissaggio alle fondamenta - Schroef voor 1 wandbalk - Kruvi poollauale  | 9 | 5x90 | |
| HS16 | Screw for foundation - Schrauben zur befestigung fundament - Vis de fixations des poutrelles de fondations - Viti x fondamenta - Schroef voor fundering - Kruvi alusraamile  | 40 | 5x90 | |

Art. Nr. 4428402

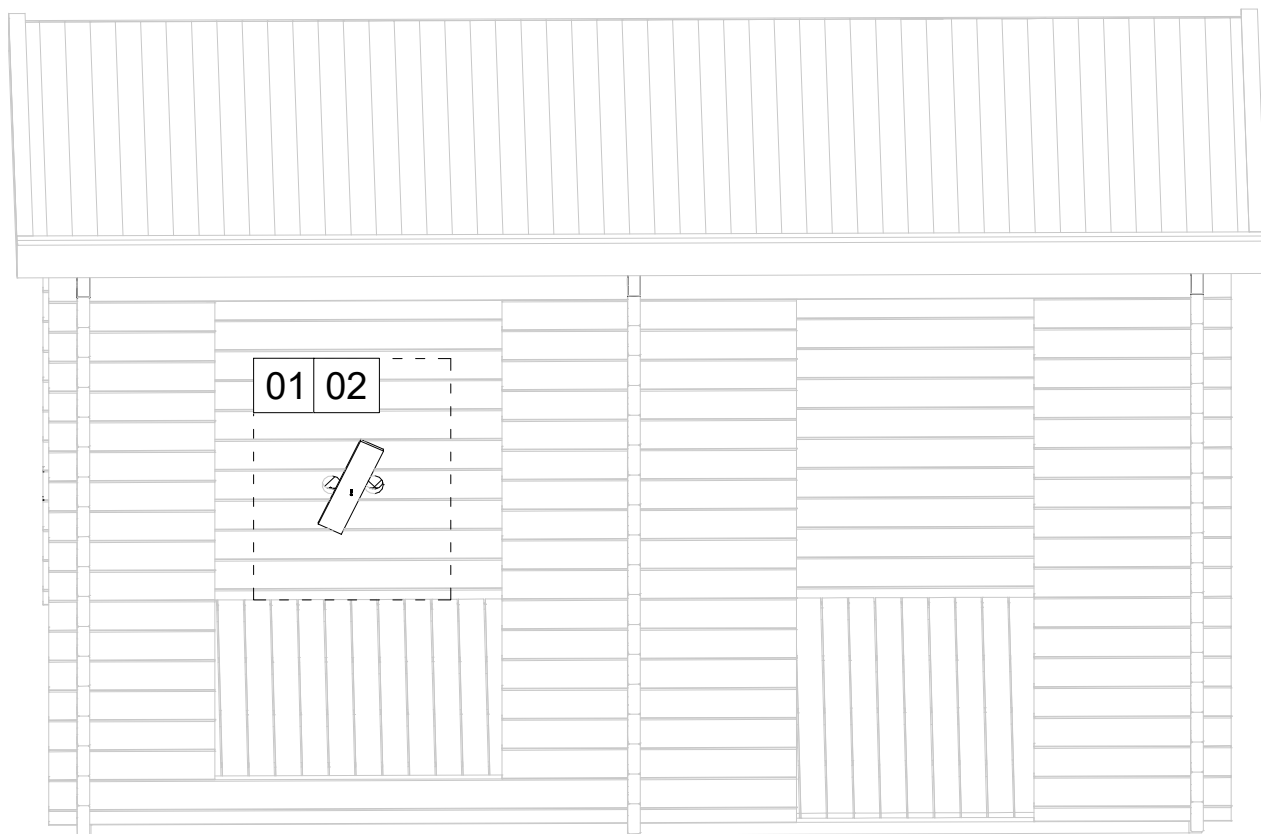

01

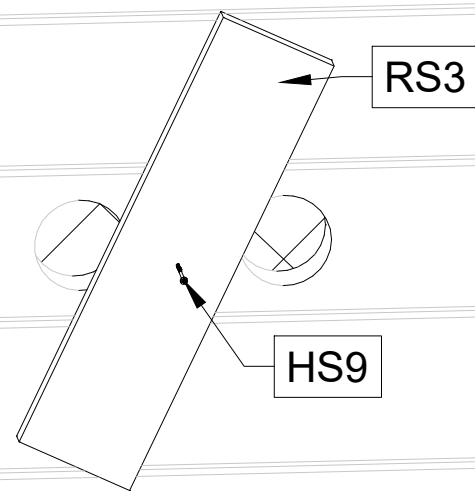

02

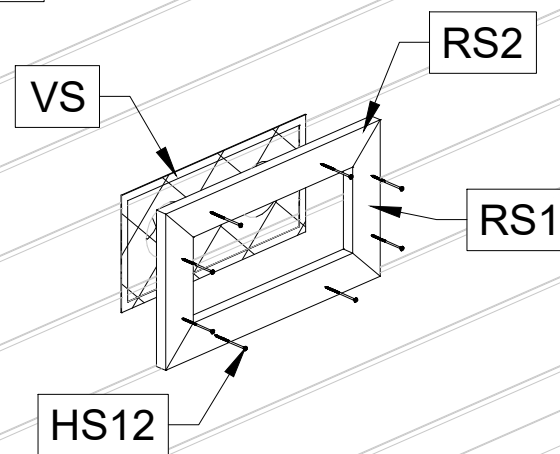

Art. Nr. 4428402

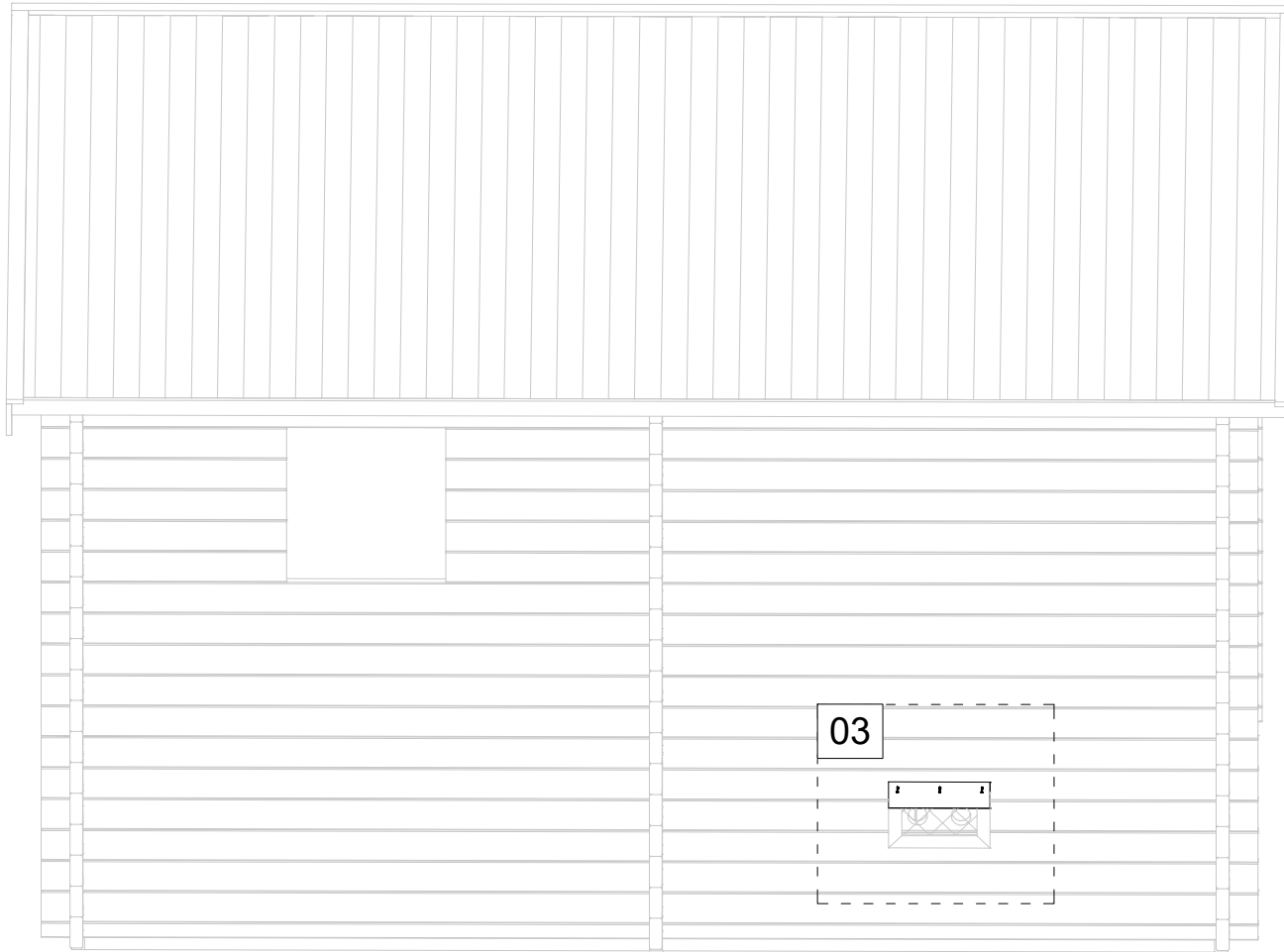

03

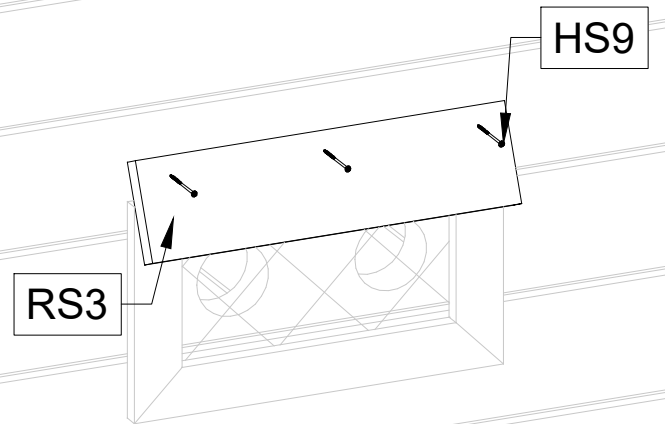

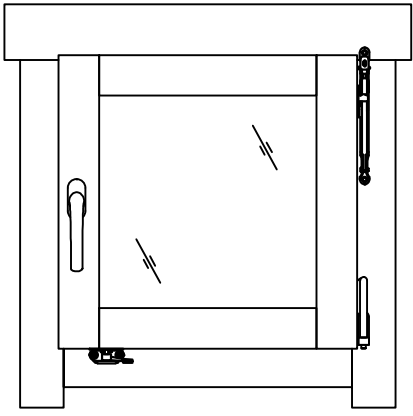
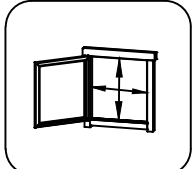
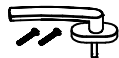



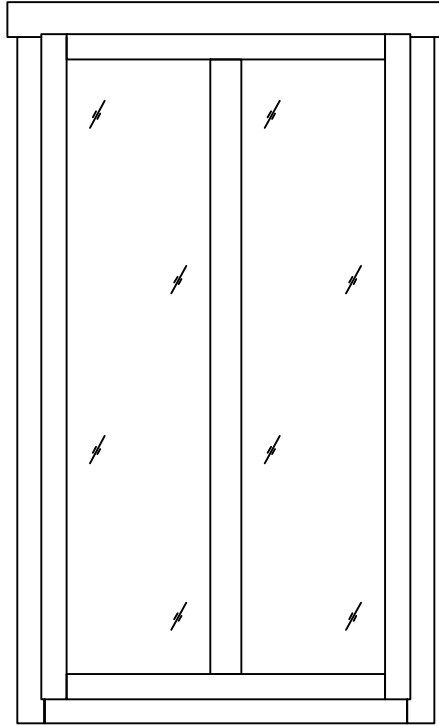

| Pos | 10.11.2017 Piece list - Stückliste - Liste des pièces - Elementi - Stuklijst - Tükítabel 540x540 AK.1.100.TPSP.a DGP+ | 1/1 | Q | P (mm) | L (mm) |
|-----|---|---|---|-----------|-----------|
| | <p data-bbox="263 156 1284 190">Glass size - Glasgröße - Taille de la vitre - Misura del vetro - Glas afmeting - Klaasi mõõt: 370x362 mm</p>   <p data-bbox="1364 347 1492 380">440x444 mm</p> | | | | |
| FS2 | <p data-bbox="263 2128 1021 2184">Window handle fittings - Fenstergriff - Poignee de fenetre - Maniglia c/ferramenta - Raamhendel -/grendel -/klink - Aknalink</p> |  | 1 | | |

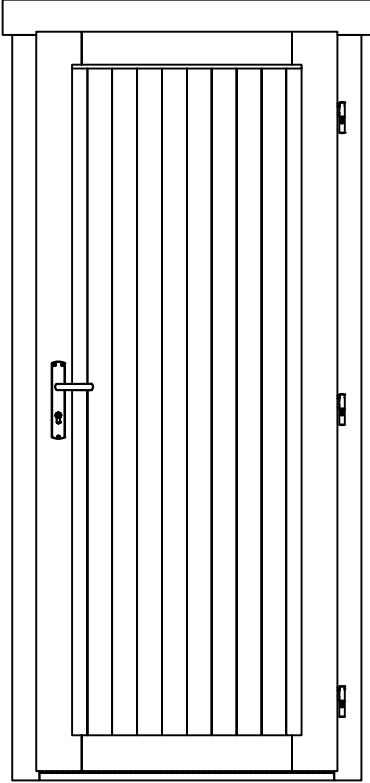
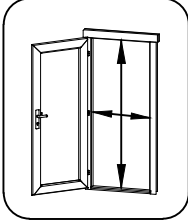
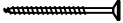
| | | | | | | |
|-----|------------|--|-----|---|-----------|-----------|
| Pos | 10.11.2017 | Piece list - Stückliste - Liste des pièces - Elementi - Stuklijst - Tükítabel 1010x1780 TAK.1.100.TPM0.e DGP+ | 1/1 | Q | P (mm) | L (mm) |
|-----|------------|--|-----|---|-----------|-----------|

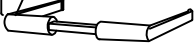
Glass size - Glasgröße - Taille de la vitre - Misura del vetro - Glas afmeting - Klaasi mõõt: 390x1602 mm

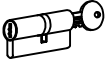

| Pos | 28.10.2016 | Piece list - Stückliste - Liste des pièces - Elementi - Stuklijst - Tükítabel 835x1957 UL.2.100.IVP.MMW TP+ | 1/1 | Q | P (mm) | L (mm) |
|------|--|--|-----|--------|-----------|--|
| |  | | | | | |
| | | | | | |  735 x 1873 mm |
| HS16 | Screw for door jamb - Schraube für türrahmen - Vis de fixation partie haute avec montants du cadre de porte - Viti x fissaggio montanti porte - Schroef voor deurkozijn - Kruvi ukse lengile |  | 4 | 5x90 | | |
| HS25 | Screw for doorstep - Schrauben für swelle - Vis pour fixation barre de seuil - Vite per soglia della porta - Schroef voor deurdorpel - Kruvi lävepakule |  | 2 | 4.5x65 | | |
| MH | Male bolt hinge for door - Türband - Partie male de paumelle de porte - Cerniera anube x porta - Scharnier bout - Reguleeritav polthing isane |  | 3 | 14x80 | | |
| TL4 | Door handle fittings - Türgriff - Poignée de porte - Maniglie - Deurhendel klink - Ukse käepide |  | 1 | | | |
| TL5 | Set of door lock covers - Schlossblenden - Set de garnitures de porte - Copertura serrature - Slot sluitplaat set - Ukse lukuplaat |  | 1 | | | |
| | Cylinder lock - Zylinderschloss - Barillet de porte - Serratura - Cylinder slot - Ukse lukusüdamik |  | 1 | 30x35 | | |
| HC | Covers for door hinges - Schutzkappe für türband - Couverture de paumelle de porte - Copertura delle cerniere della porta - Afdek kap voor deurscharnier - Reguleeritava polthinge kate |  | 6 | | | |