

Art. Nr. 4428802

1/17

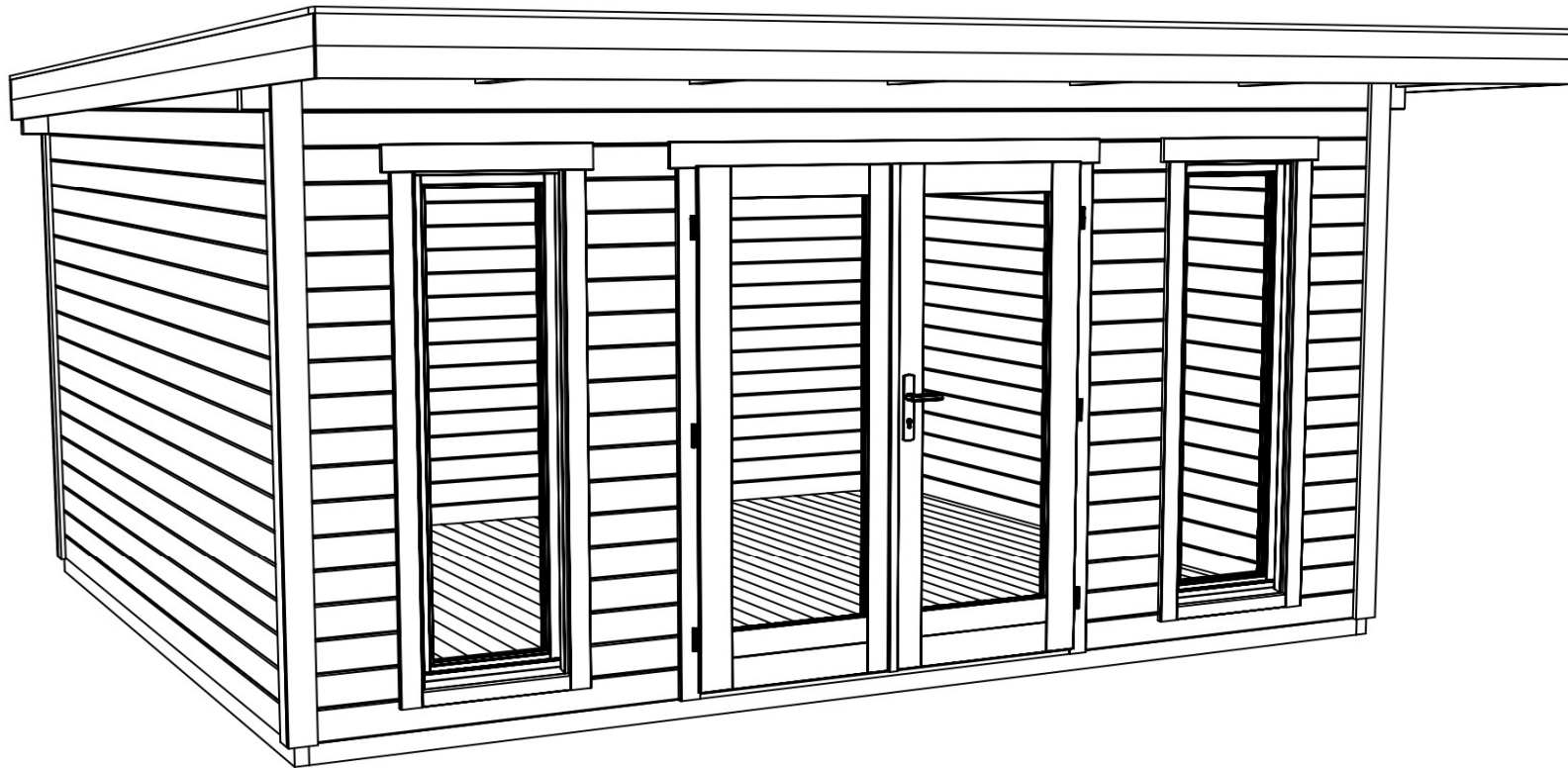

04.05.2023

Art.Nr. 4428802

Groundplan - Grundplan - Plan de masse - Planimetria - Plattegrond -
Planimetria - Põhiplaan

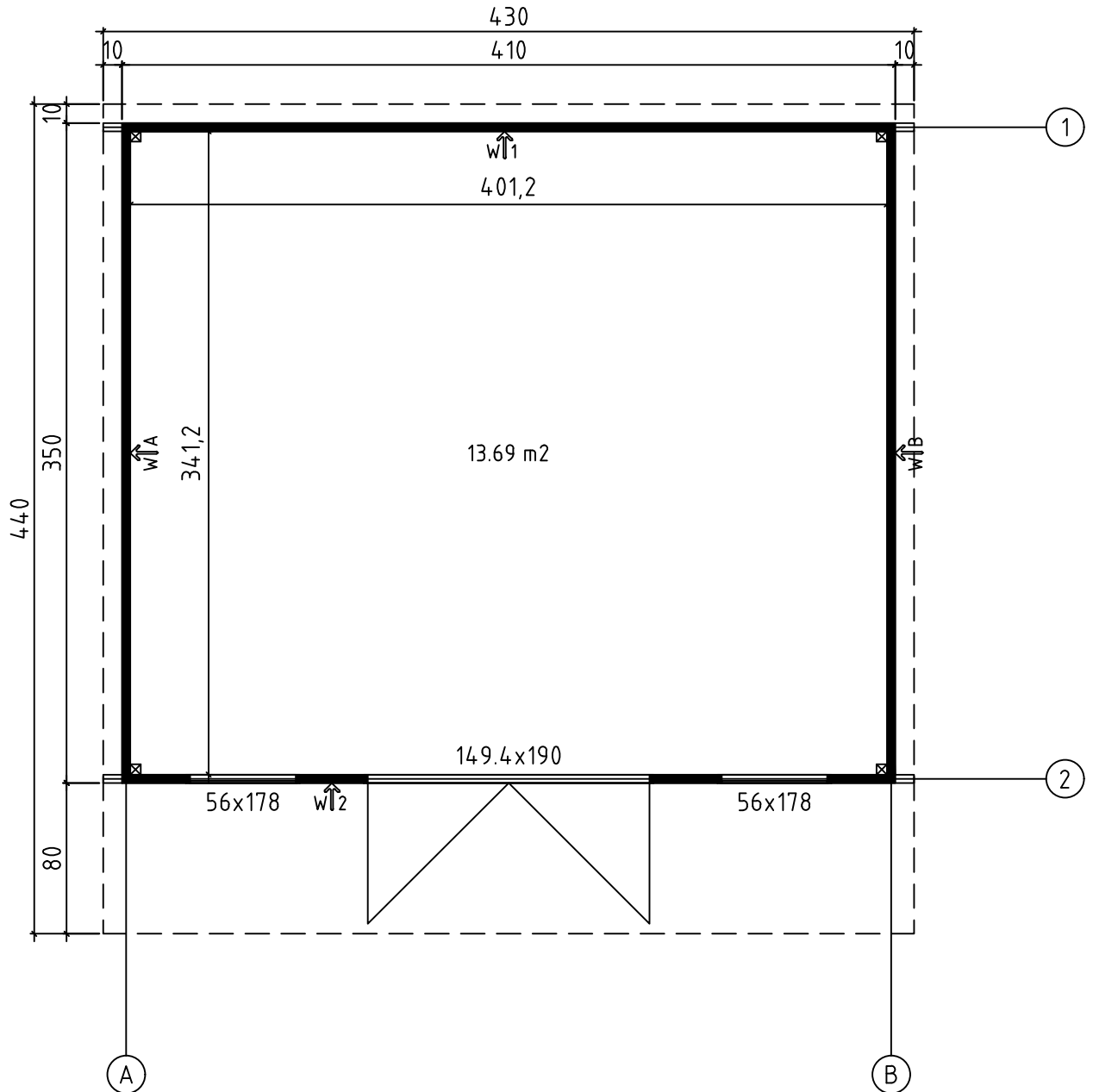

Art.Nr. 4428802

Foundation - Fundament - Fondation - Fondamenta - Fundering -
Bastidor impregnado - Immutatud alusraam

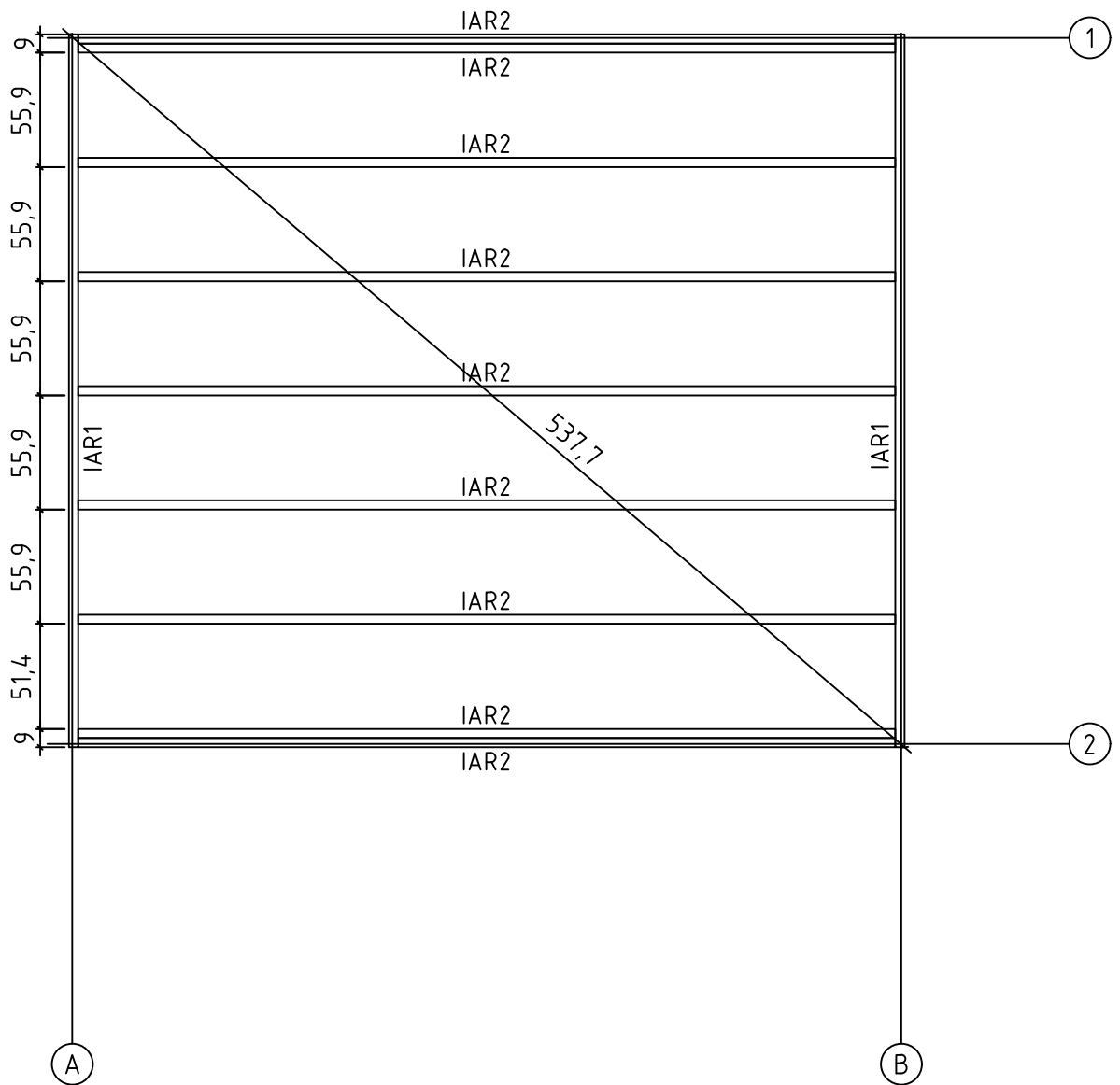





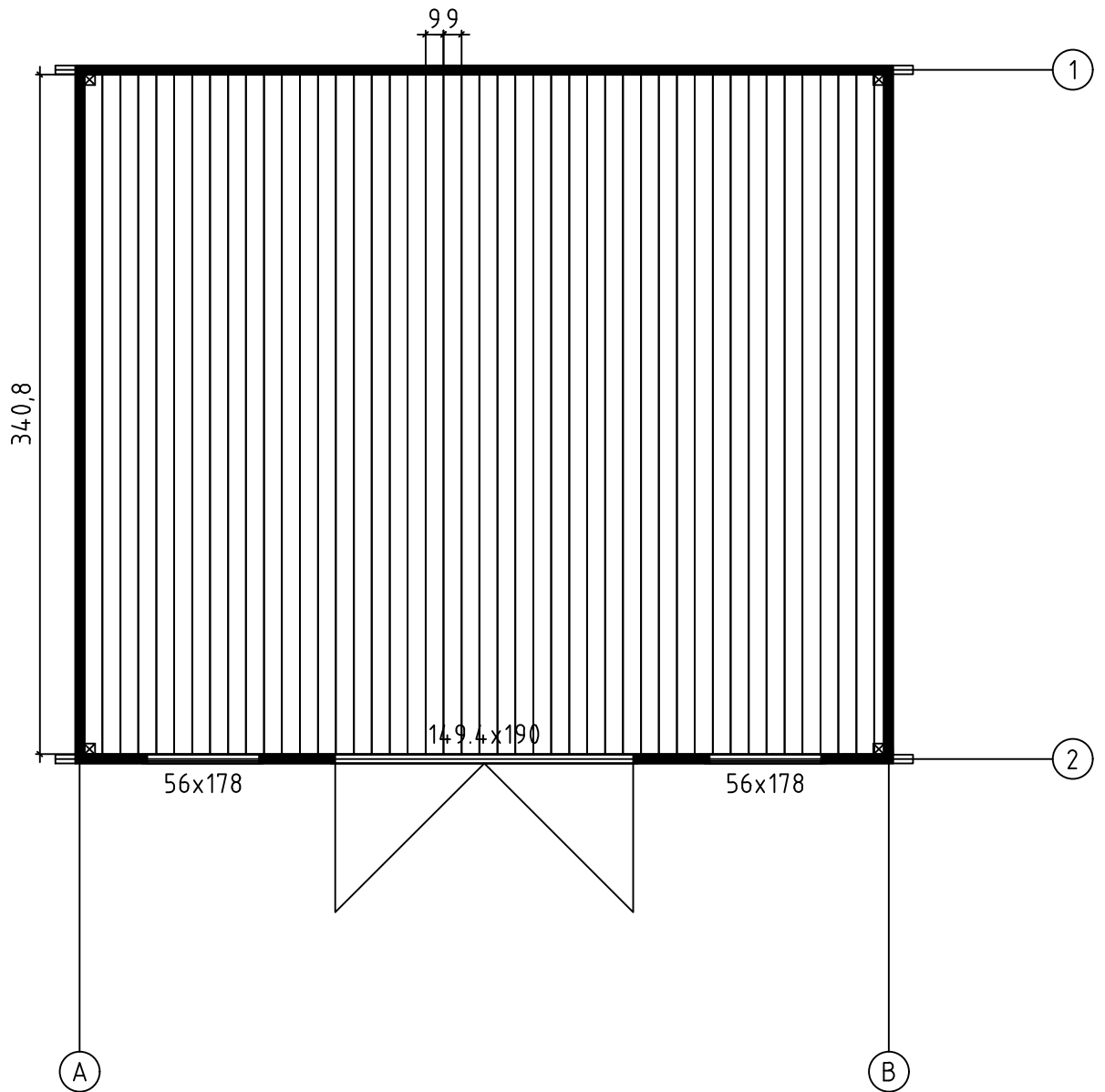

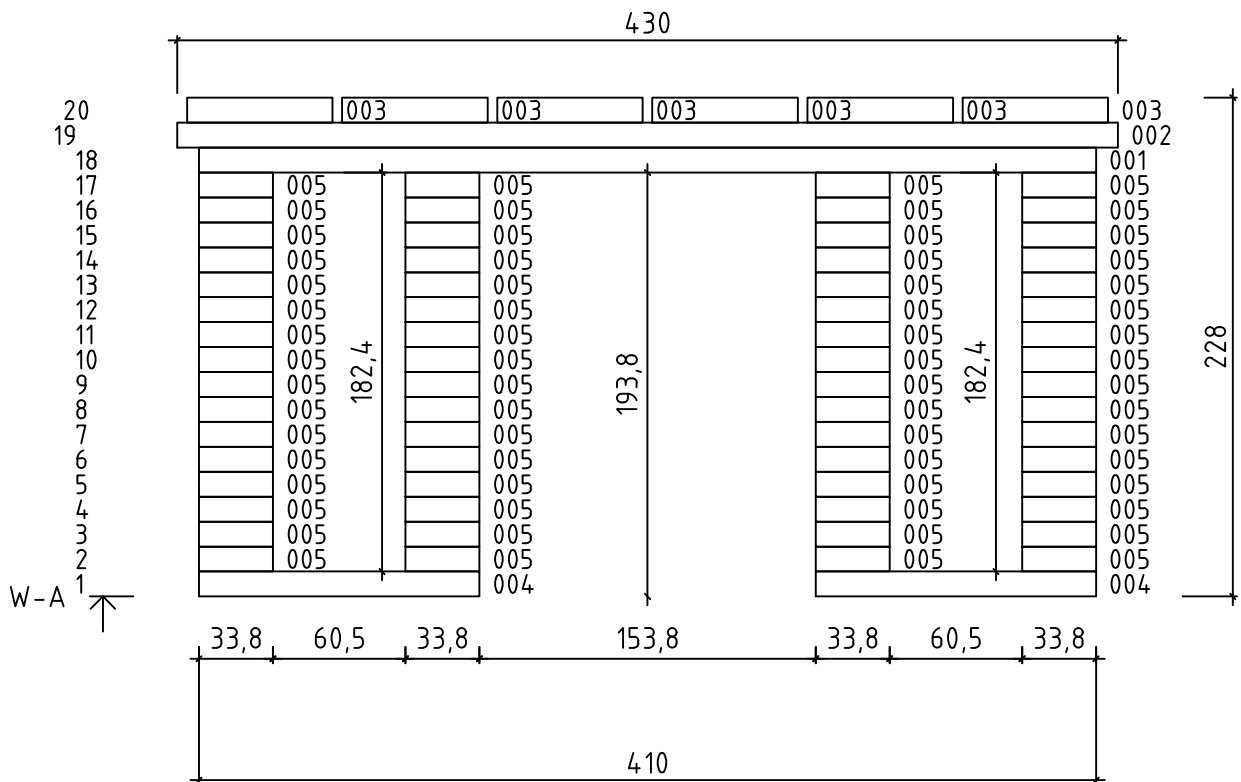
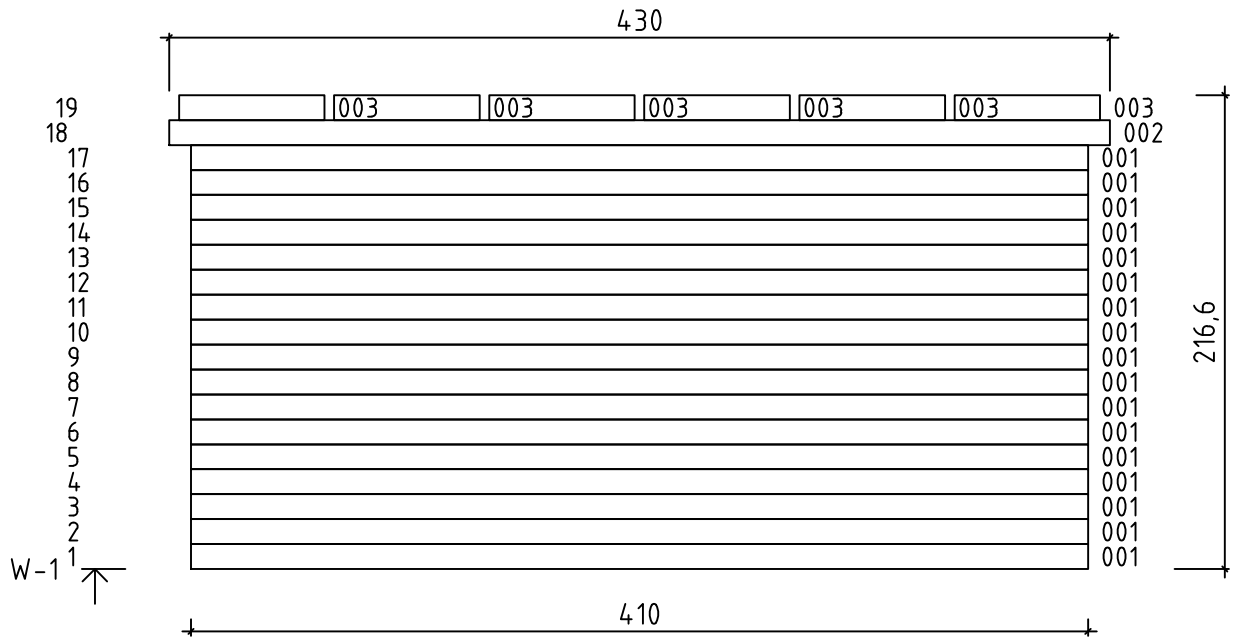

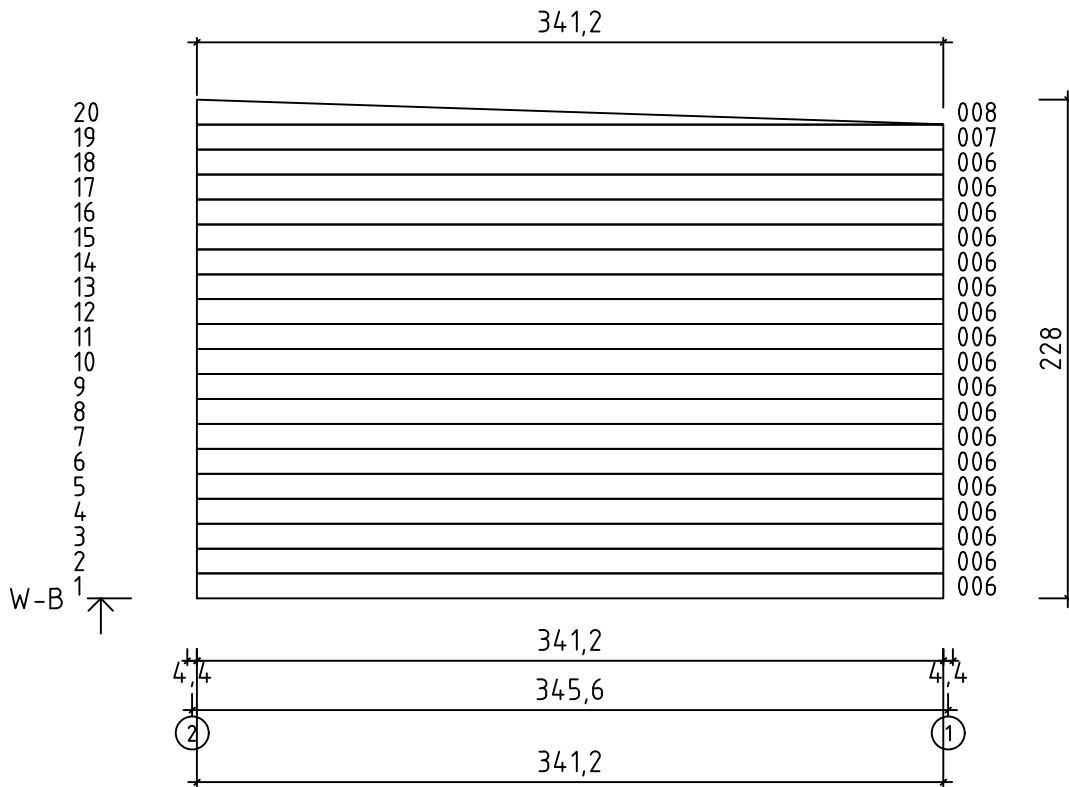
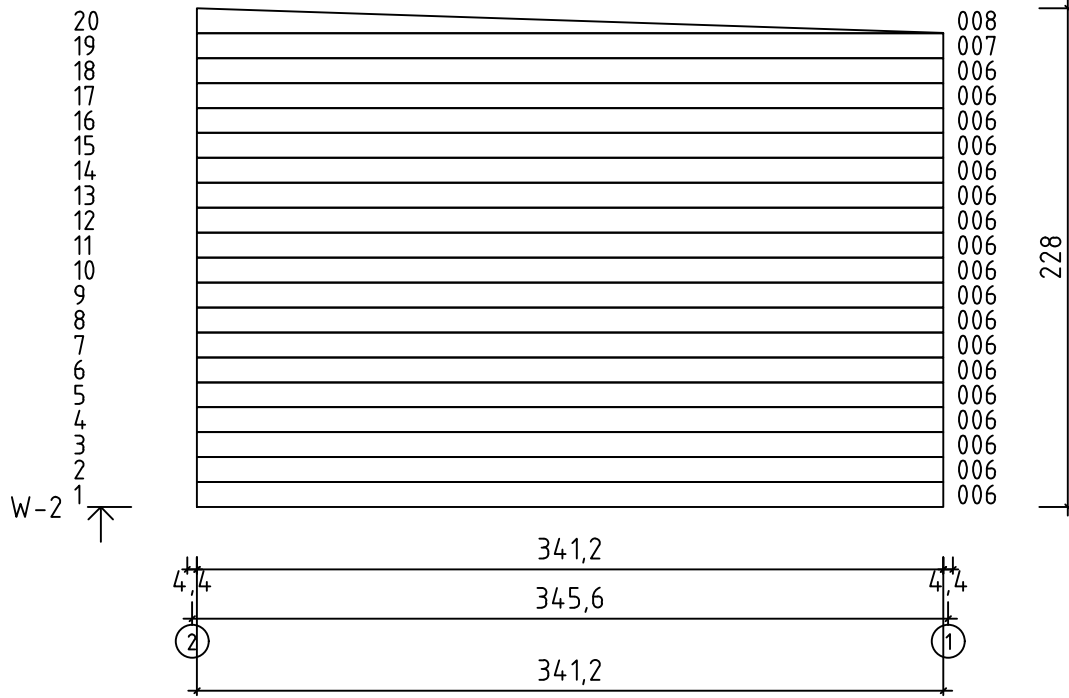

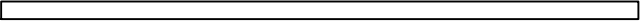

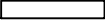
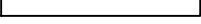

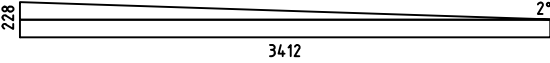
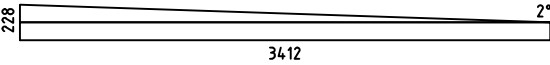
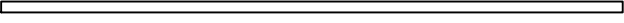
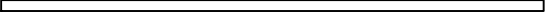
Art.Nr. 4428802





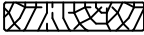

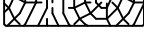

Floor boards - Fussbodenbretter - Plan pose plancher - Pavimento -
Vloerhout - Tarima de suelo - Põrandalaudis

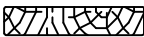
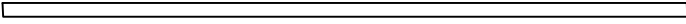

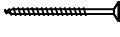
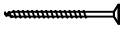

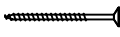
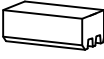
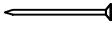
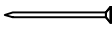
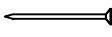

Pos	04.05.2023	Piece list - Stückliste - Liste des pièces - Elementi - Stuklijst - Elementos - Tükítabel Art.Nr. 4428802	7/17	Q	P (mm)	L (mm)
001 44301				18	44x114	4100
002 45952				2	44x114	4300
003 45778				12	44x114	665
004 45767				2	44x114	1281
005 45768				64	44x114	338
006 40159				36	44x114	3412
WA-1 45770				1		
WB-1 45770				1		
IAR2 2726		Foundation - Fundament - Fondation - Fundamenta - Fundering - Bastidor impregnado - Immutatud alusraam 		9	45x70	4000
IAR1 39413		Foundation - Fundament - Fondation - Fundamenta - Fundering - Bastidor impregnado - Immutatud alusraam 		2	45x70	3490
SR1 45771		Rafter - Dachsparren - Chevron - Trave - Dak spar - Cabio - Sarikas 		7	44x140	4407
FB-1 32155		Floor boards - Fussbodenbretter - Lame de plancher - Pavimento - Vloerhout - Tablero de suelo - Põrandalaud 		45	90x18	3408
RB-1 10881		Roof boards - Dachbretter - Voliges - Perlina per tetto - Dakhout - Tablero de tejado - Katusepapiist 		49	90x18	4300
FL-1 30087		Floor fillet - Fussbodenleiste - Corniere de finition du plancher - Finitura per pavimento (battisco pa) - Vloerafwerkljst - Rodapié - Põrandaliist 			18x18	15
DPL-1 45772		Roofing felt fillet - Dachpappenleiste - Baguette de fixation du feutre bitumeux - Asse per fissaggio guaina bituminosa - Afdekljst asfaltpapier - Moldura de fieltro para tejado - Katusepapiiist 		1	18x58	4336
DPL-2 24933		Roofing felt fillet - Dachpappenleiste - Baguette de fixation du feutre bitumeux - Asse per fissaggio guaina bituminosa - Afdekljst asfaltpapier - Moldura de fieltro para tejado - Katusepapiiist 		2	18x58	4380
TBE2-1 975		Corner fillet - Deckleiste - Profils de finition angles a l'exterieur - Massello d'angolo - (hoek)lijst - Moldura de esquina - Nurgaliist 		2	18x90	1938
TBE2-2 1377		Corner fillet - Deckleiste - Profils de finition angles a l'exterieur - Massello d'angolo - (hoek)lijst - Moldura de esquina - Nurgaliist 		2	18x90	2052
TBE2-3 7543		Corner fillet - Deckleiste - Profils de finition angles a l'exterieur - Massello d'angolo - (hoek)lijst - Moldura de esquina - Nurgaliist 		2	18x90	2166
TBE2-4 30191		Corner fillet - Deckleiste - Profils de finition angles a l'exterieur - Massello d'angolo - (hoek)lijst - Moldura de esquina - Nurgaliist 		2	18x90	2280
P-1 45773		Post - Pfosten - Poteau - Piede registrabile - Stijl - Poste - Post 		2	55x55	2166

Pos	04.05.2023 Piece list - Stückliste - Liste des pièces - Elementi - Stuklijst - Elementos - Tükítabel Art.Nr. 4428802	8/17	Q	P (mm)	L (mm)
P-2 44805	Post - Pfosten - Poteau - Piede registrabile - Stijl - Poste - Post		2	55x55	2280
TB-1 3854	Fascia board - Traufbrett - Bandeau de toit - Finitura lati tetto - Gevellijst - Tablero de alero - Räästalaud		4	18x90	4336
TB-2 45774	Fascia board - Traufbrett - Bandeau de toit - Finitura lati tetto - Gevellijst - Tablero de alero - Räästalaud		4	18x90	4405
TBE4-1 24897	Fixing fillet - Fixierungsleiste - Profil de fixation - Massello di fissaggio - Bevestiging lijstwerk - Moldura en T - Tenderliist		4	18x44	1800
TBE4-2 43334	Fixing fillet - Fixierungsleiste - Profil de fixation - Massello di fissaggio - Bevestiging lijstwerk - Moldura en T - Tenderliist		2	18x44	1910
HS12 5109	Screw for corner fillet - Schraube zur befestigung deckleiste - Vis pour profils de finition angles a l'exterieur - Viti per massellino d'angolo - Schroef voor afdekljst (hoek) - Tornillo para moldura de esquina - Kruvi nurgaliistule		80	4x40	
HS12 5109	Screw for fascia boards - Schrauben für traufbretter - Vis pour fixation bandeau de toit - Viti x striscia del tetto - Schroef voor gevellijst - Tornillo para tablero de alero - Kruvi räästalauale		100	4x40	
HS12 5109	Screw for fixing fillet of door and window - Schrauben für fixierungsleiste - Vis pour profil vertical de fixation pour ouvertures des fenetres et portes - Viti per massello di fissaggio - Schroeven voor bevestiging van deur en raam lijsten - Tornillo para molduras en T - Kruvi tenderliistudele		35	4x40	
HS34 40958	Screw for wall details - Schraube für wand details - Vis pour mur details - Viti per elementi della porta - Schroef voor wand details - Tornillo para elementos de pared - Kruvi seinadetailidele		350	5x80	
HS16 5115	Screw for foundation - Schrauben zur befestigung fundament - Vis de fixations des poutrelles de fondations - Viti x fundamenta - Schroef voor fundering - Tornillo para bastidor - Kruvi alusraamile		25	5x90	
HS22 5120	Screw for 1. wall beam - Schraube für 1. bohlenreihe - Vis de fixations 1ere rangée de madriers avec poutrelles de fondations - Vite fissaggio alle fondamenta - Schroef voor 1 wandbalk - Tornillo para medio tablero - Kruvi poollauale		15	6x150	
HS22 5120	Screw for rafter - Schrauben für dachsparren - Vis pour chevron - Vite per trave - Schroef voor dakspar - Tornillo para cabio - Kruvi sarikatele		15	6x150	
HS23 5121	Screw for wall details - Schraube für wand details - Vis pour mur details - Viti per elementi della porta - Schroef voor wand details - Tornillo para elementos de pared - Kruvi seinadetailidele		200	6x180	
SH44 32512	Hammer block - Schlagholz - Calle de frappe - Blocco di legno da usare come cuscinetto quando si usa il martello - Slagklos - Bloque de impacto - Löögiklots		1		
NF4 5137	Zn nail for roof - Zn nägel für dachbretter - Pointe pour fixation voliges de toit - Chiodi x perline tetto - Spijker(nagel) voor dakhout - Clavo para tablero de tejado - Nael katuselauale		360	2x50	
NF4 5137	Zn nail for floor - Zn nägel für fussbodenbretter - Clous pour plancher - Chiodi x perline pavimento - Spijker(nagel) voor vloer - Clavo para tablero de suelo - Nael pörandalauale		330	2x50	
NF5 5145	Zn nail for roofing felt fillet - Zn nägel für dachpappenleiste - Pointe pour baguette de fixation feutre bitumeux - Chiodi x carta bituminosa x tetto - Spijker(nagel) voor asfaltpapier afdekljst - Clavo de moldura de fieltro - Papiliistunael		30	2x40	
33696	Window - Fenster - Fenetre - Finestra - Raam - Ventana - Aken 560x1780 AK.1.100.TPSP DGP+		1		
33724	Window - Fenster - Fenetre - Finestra - Raam - Ventana - Aken 560x1780 AK.1.100.TPSV DGP+		1		
38014	Door - Tür - Porte - Porte - Deur - Puerta - Uks 1494x1900 TUK.1.100.TPVP.MMJ DGP+		1		

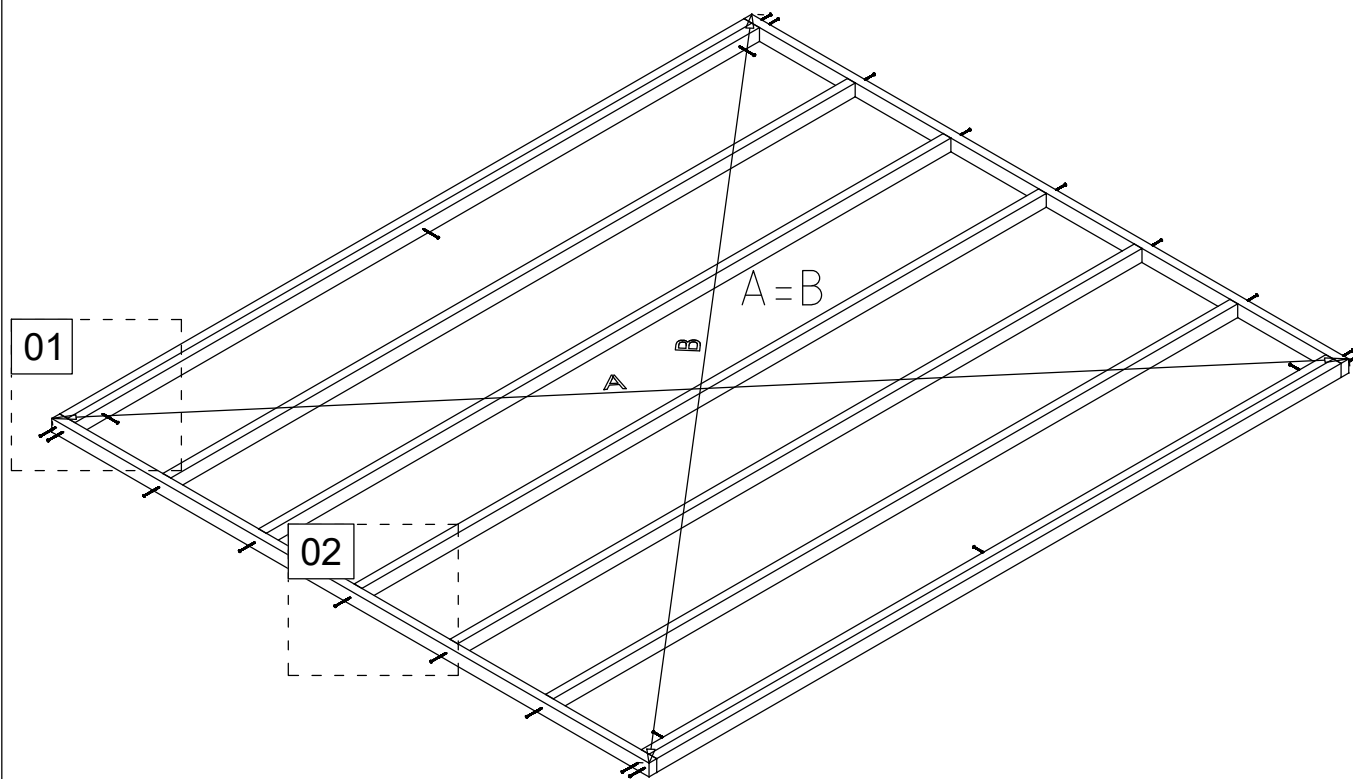

01

HS16

IAR2

HS16

IAR1

02

HS16

IAR2

IAR1

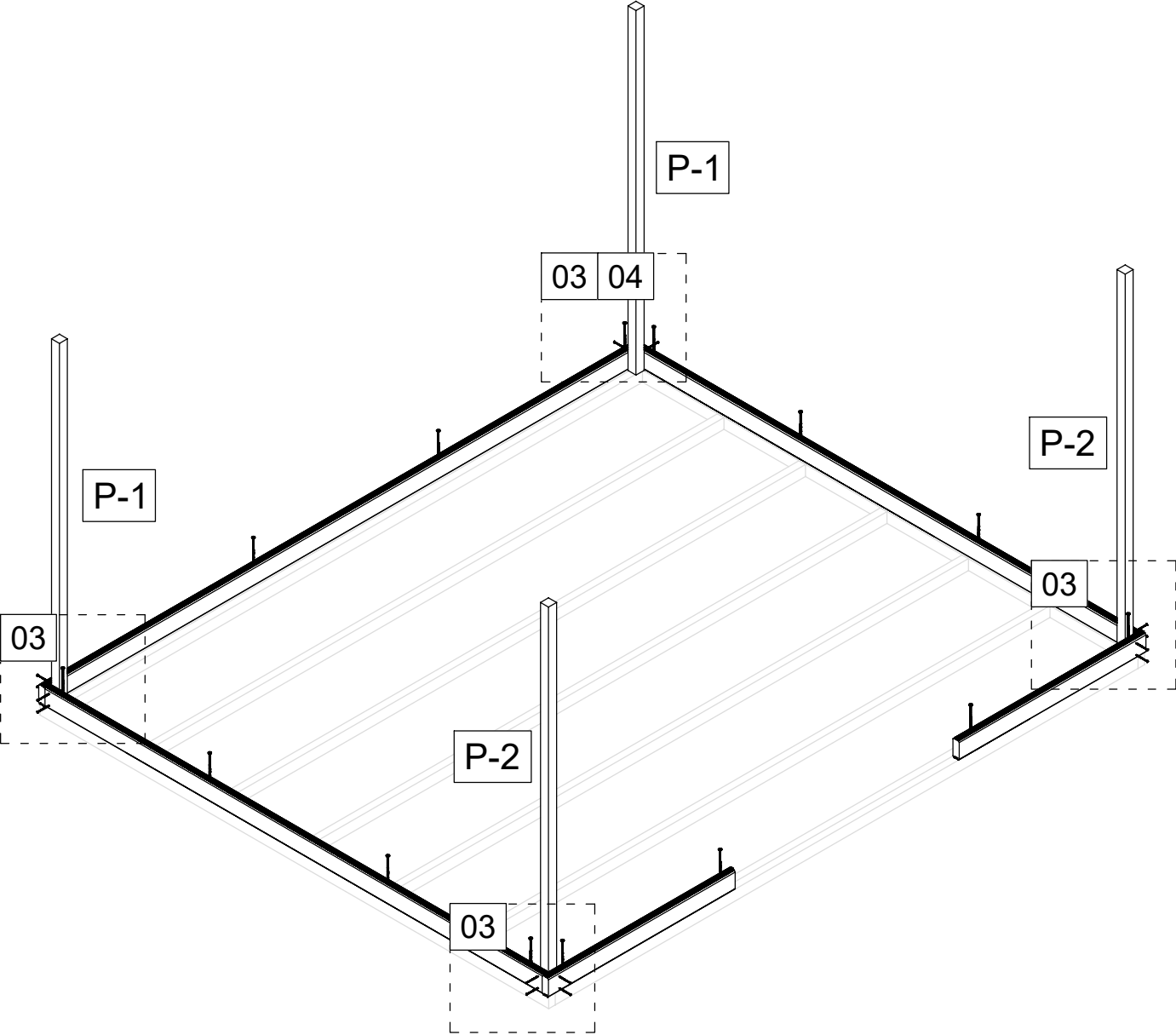

03a

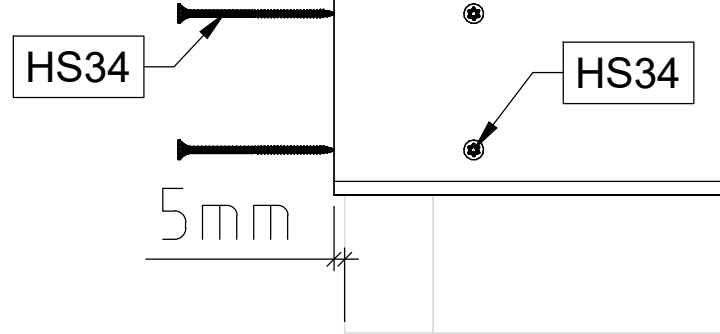

03b

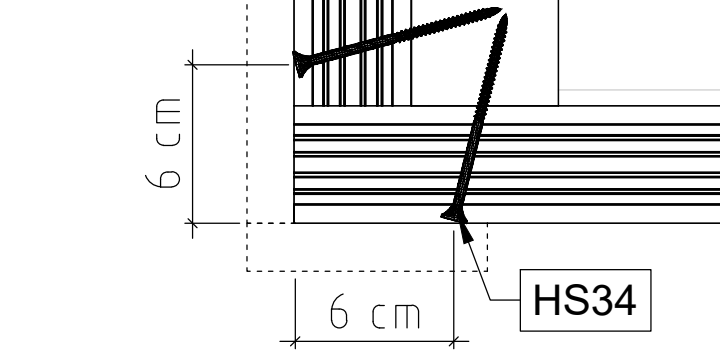

04

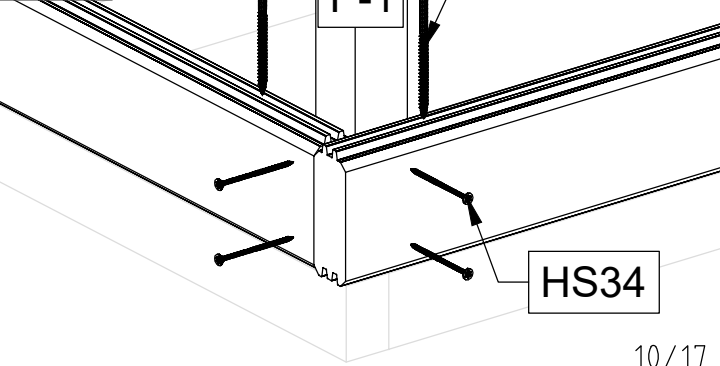

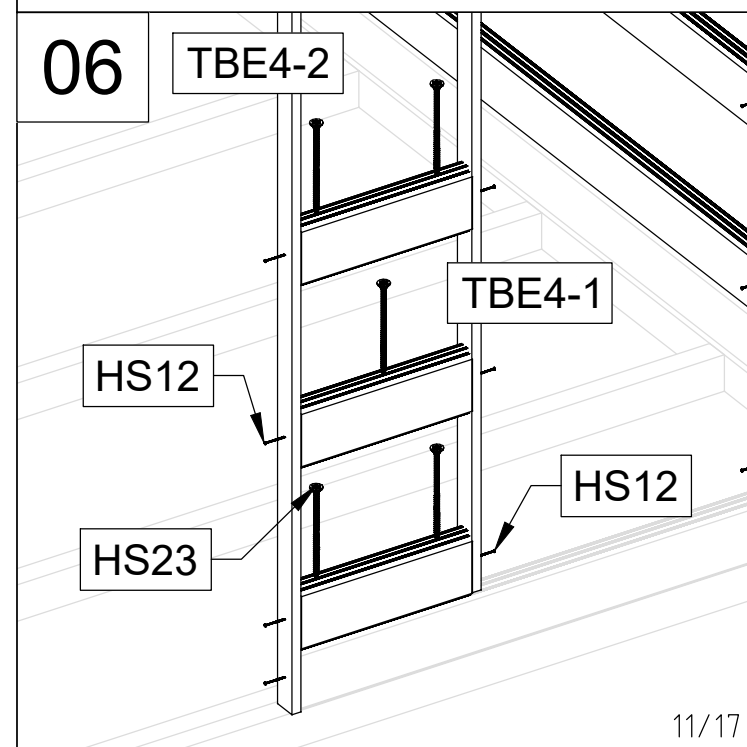
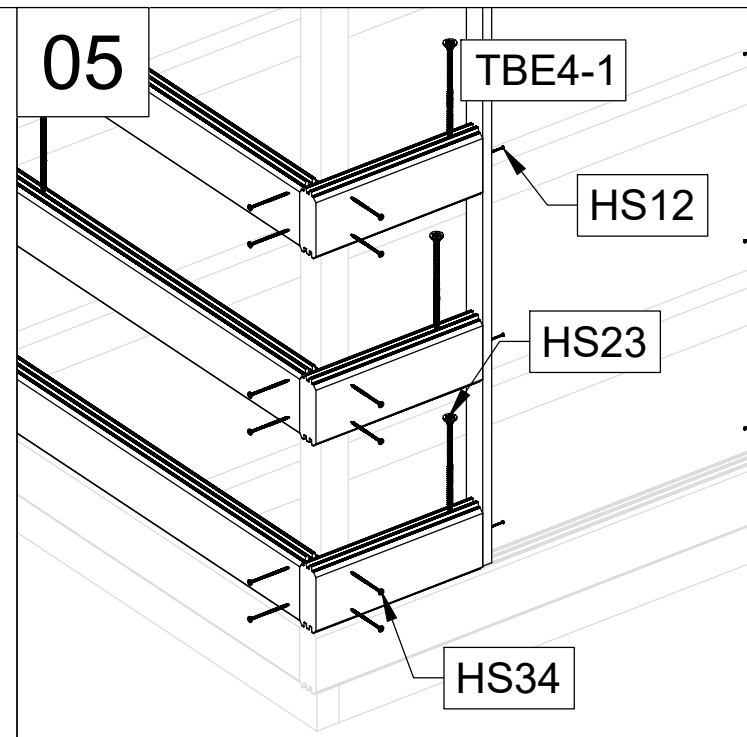
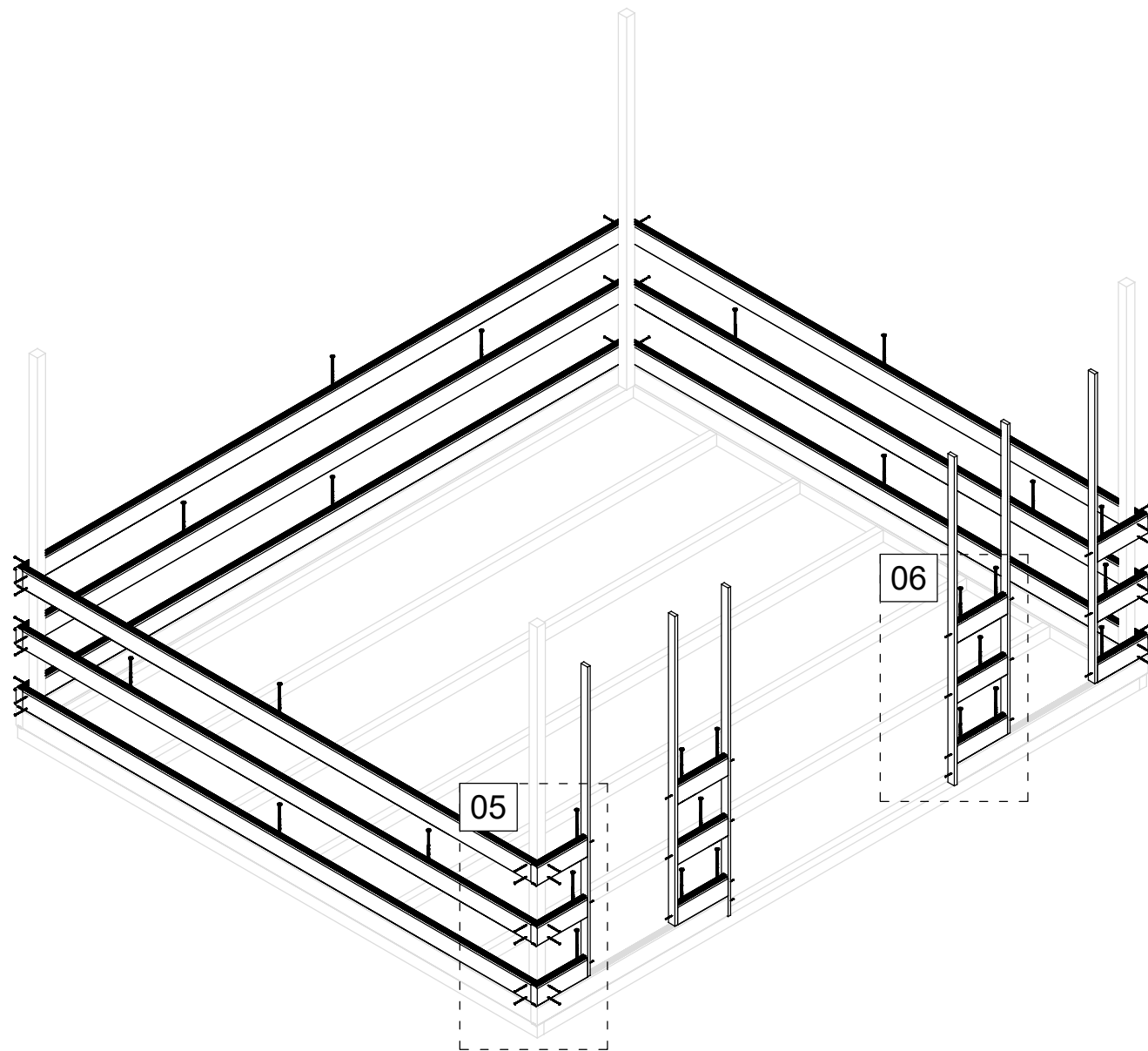

Art. Nr. 4428802

08

07

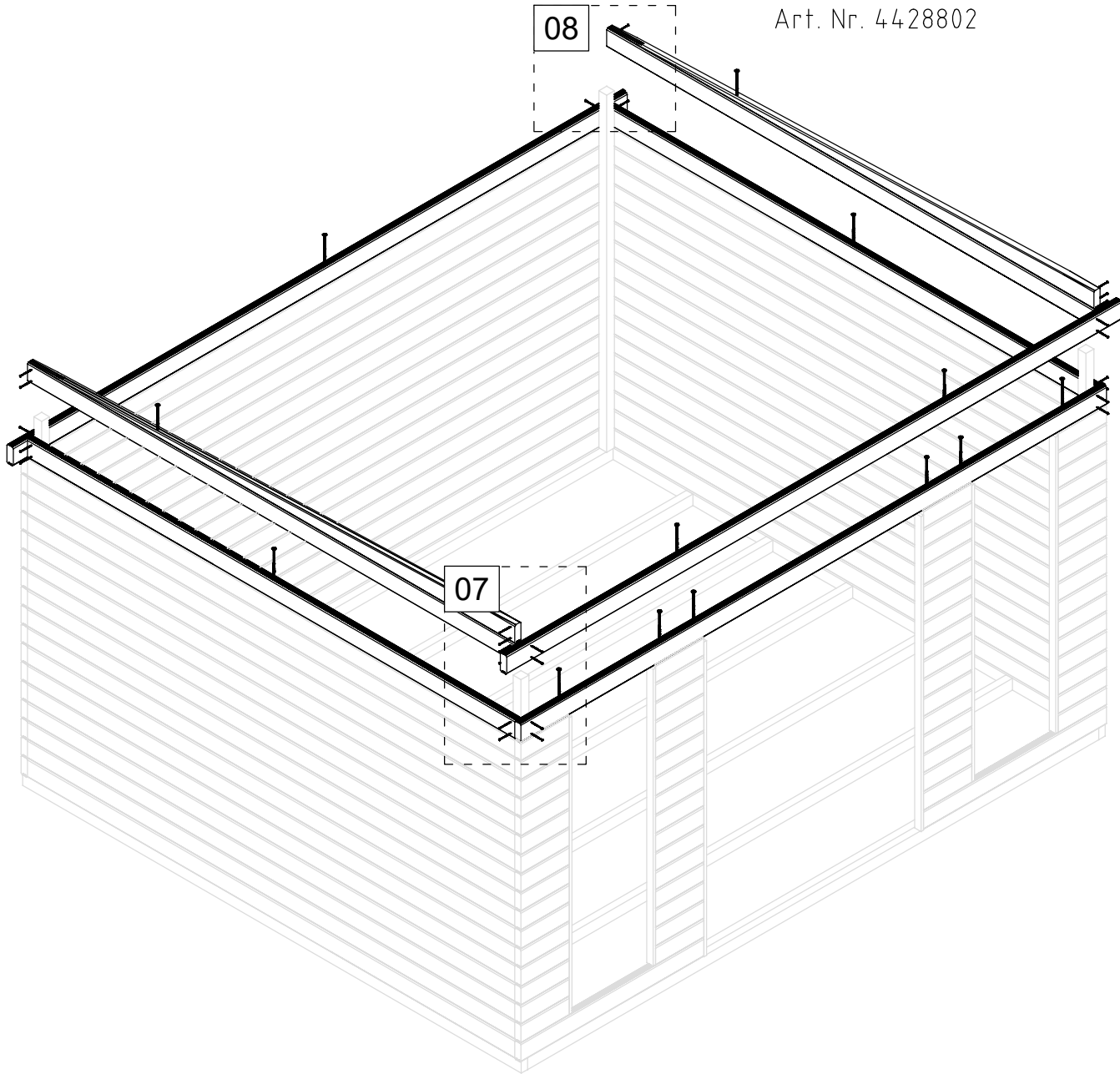

07

HS23

HS34

08

HS34

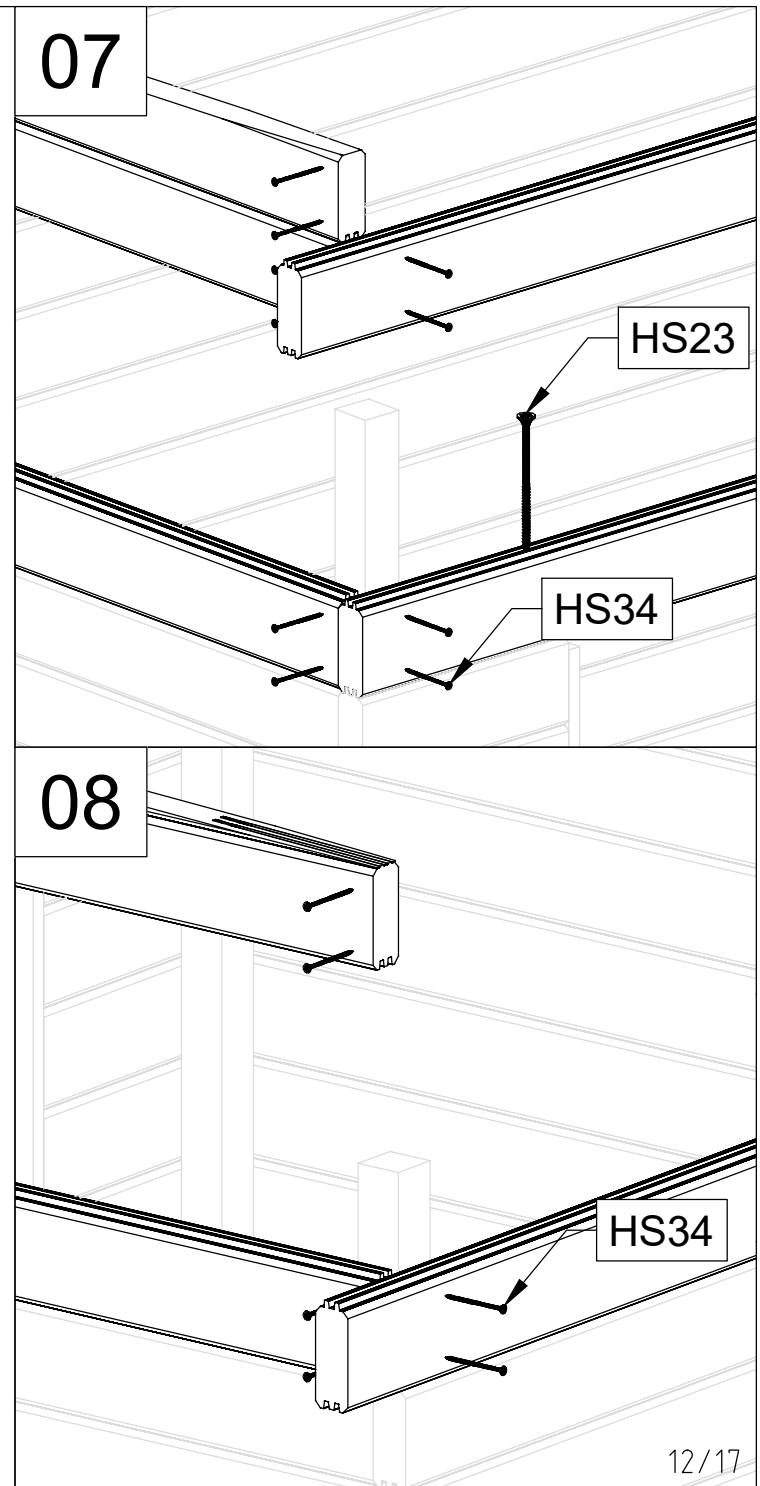

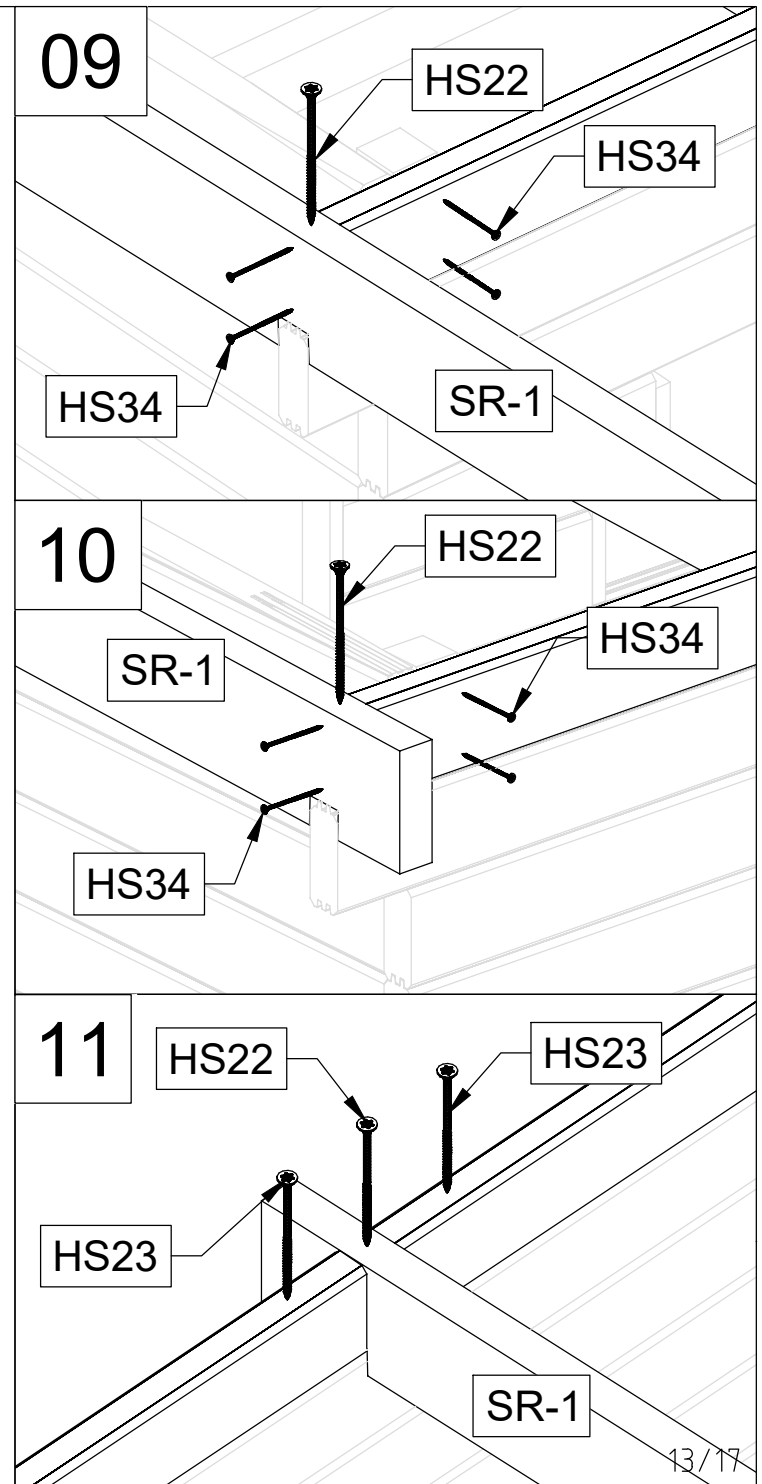
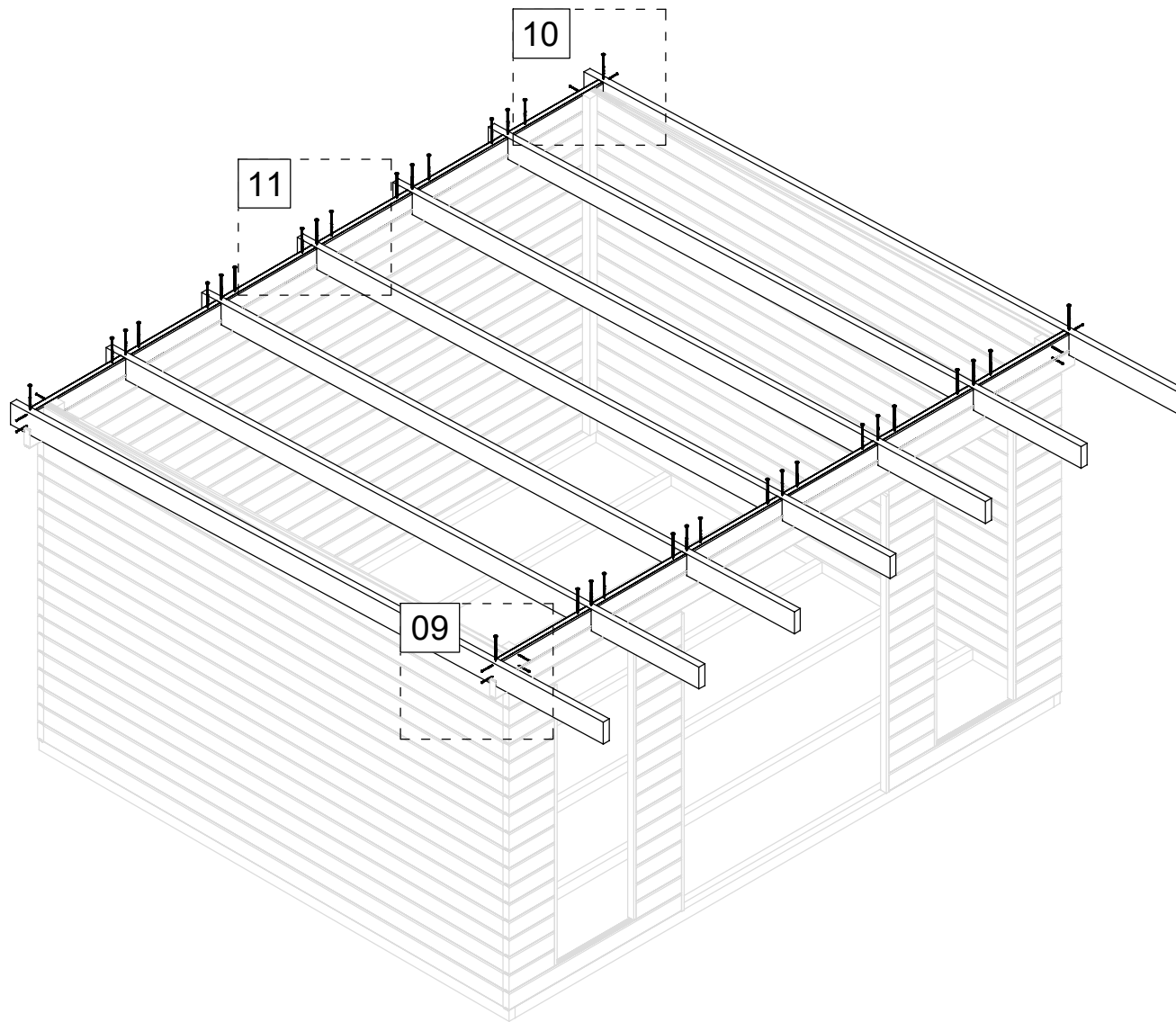

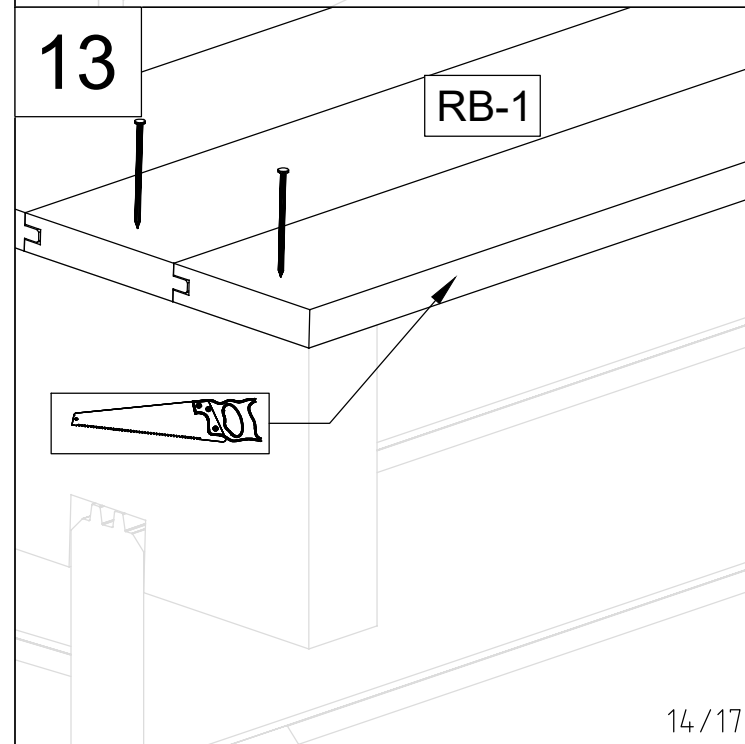
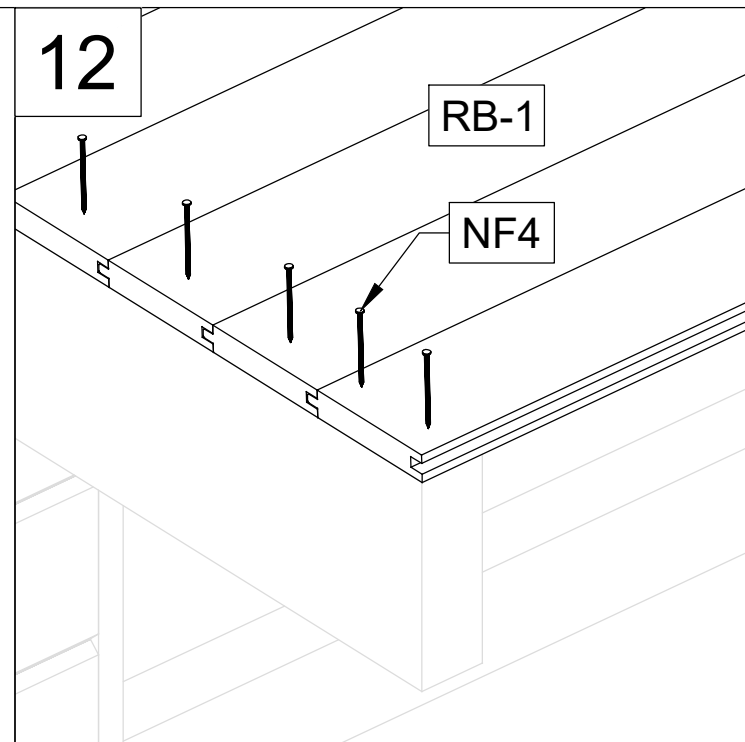
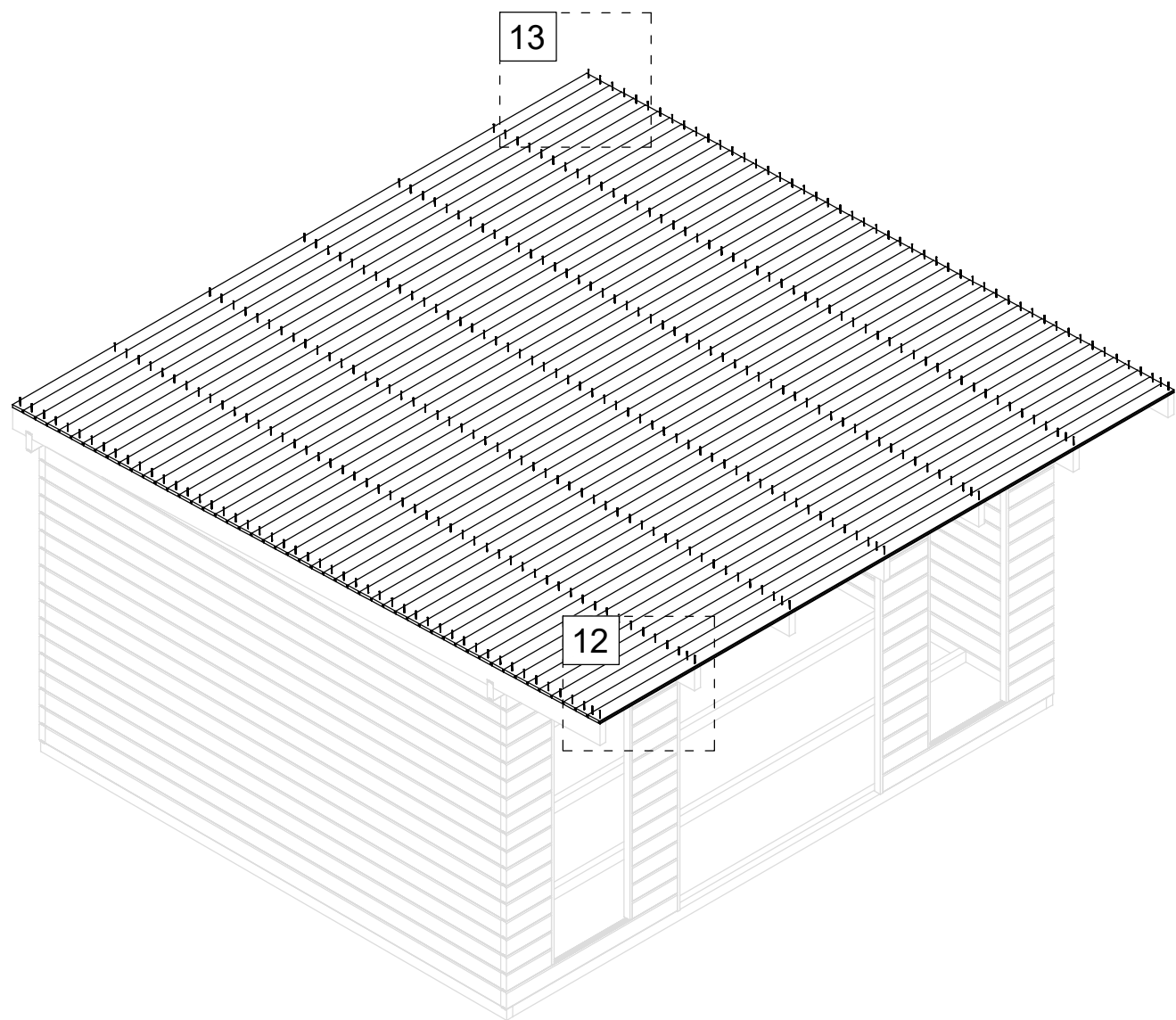

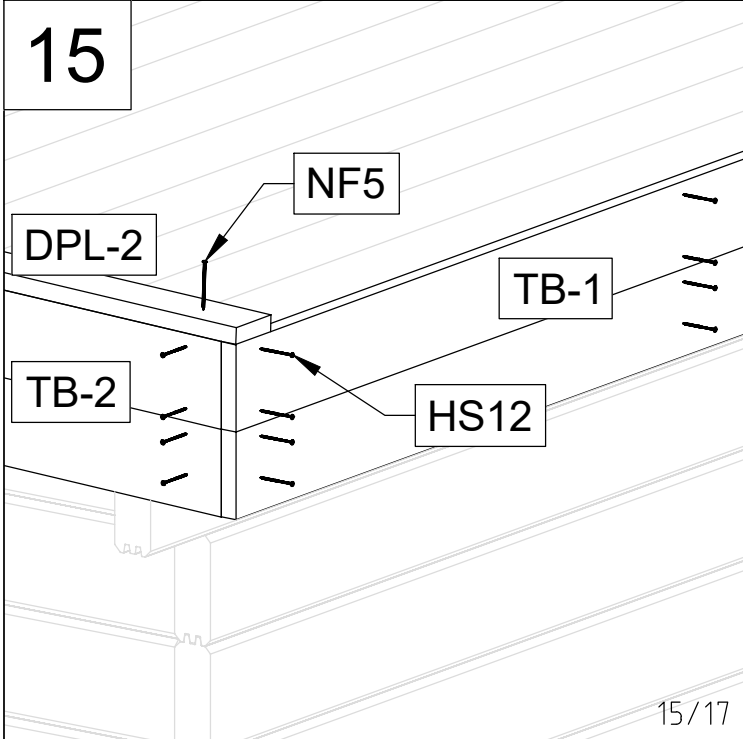
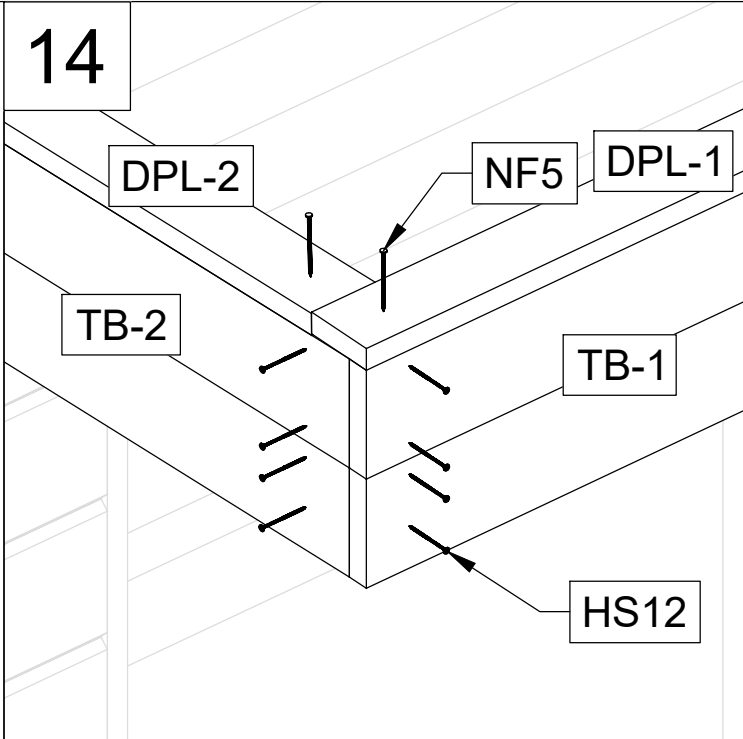
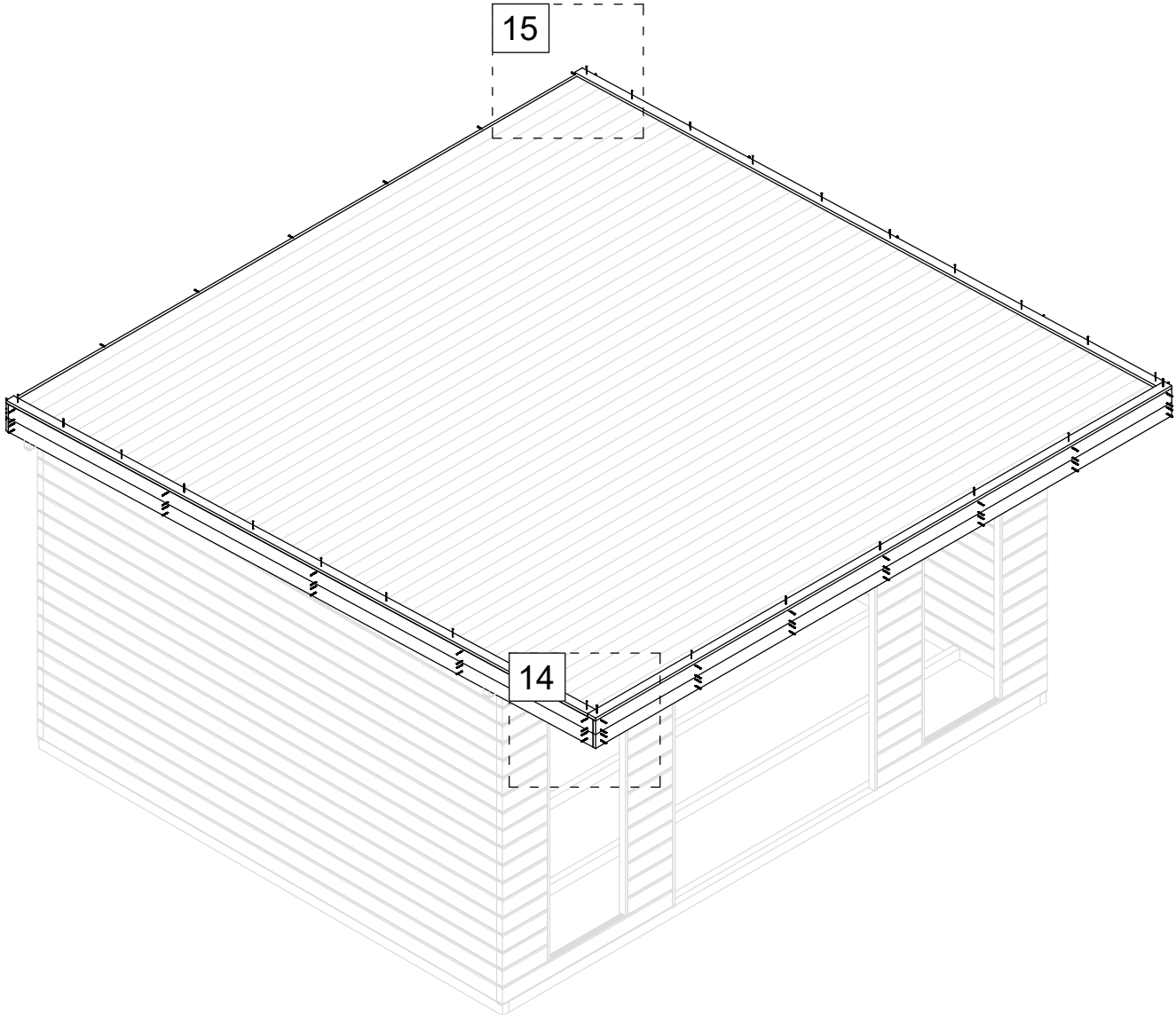

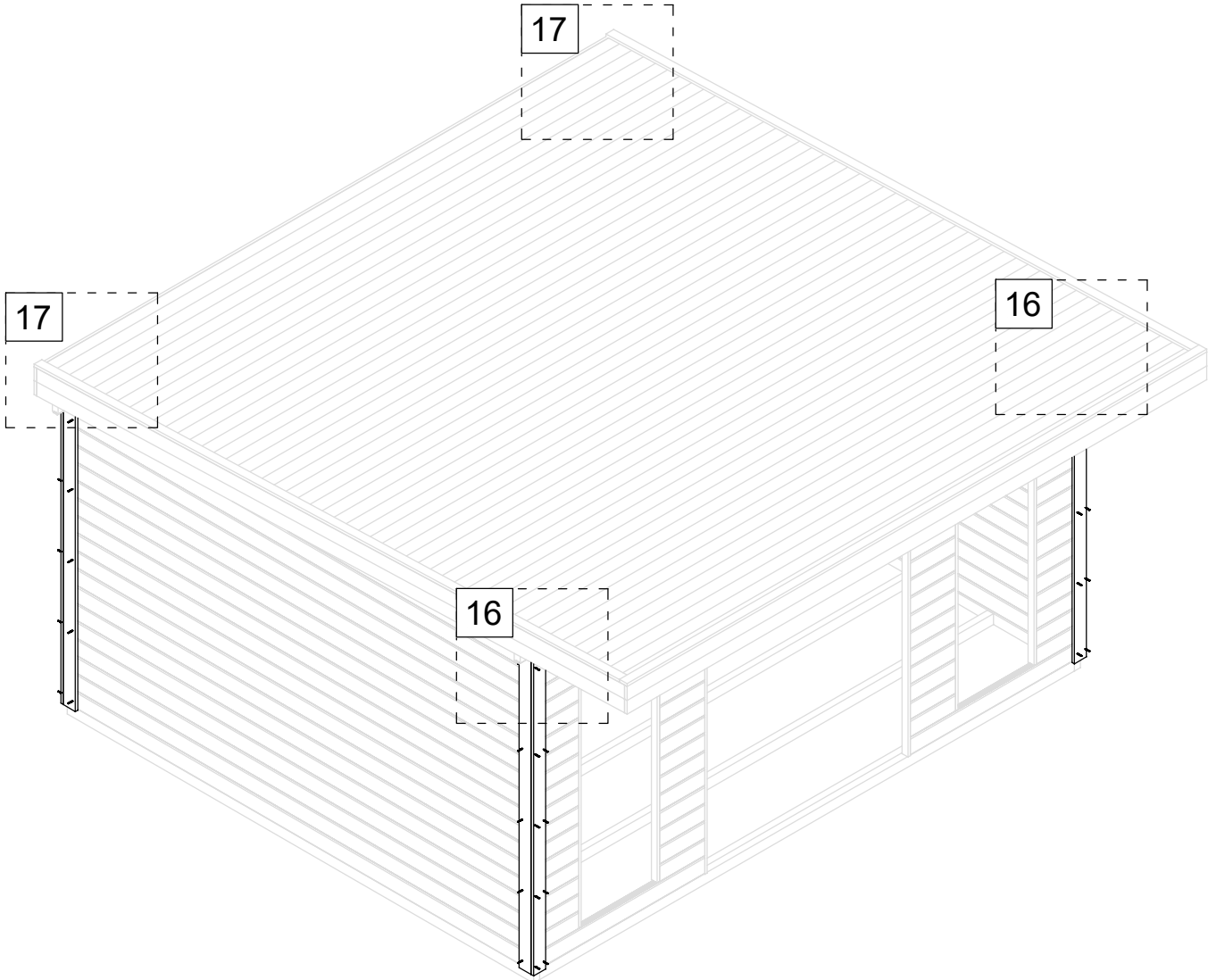

16

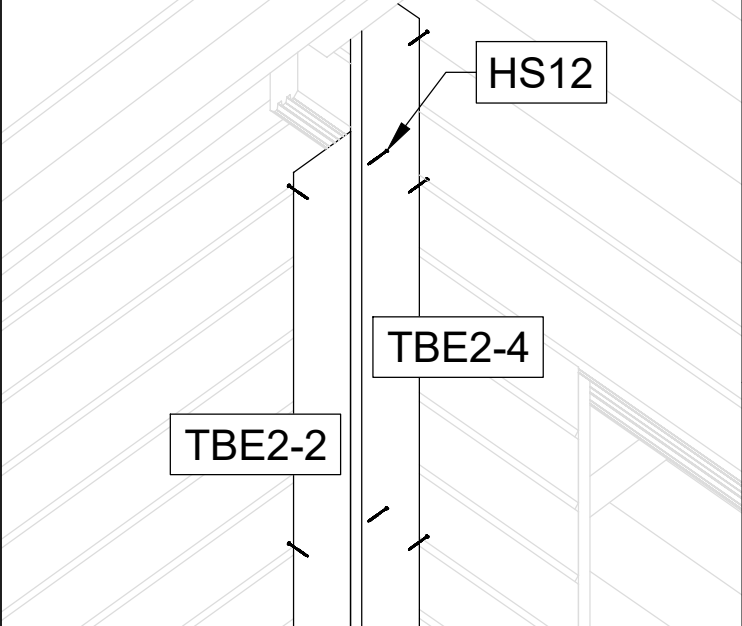

17

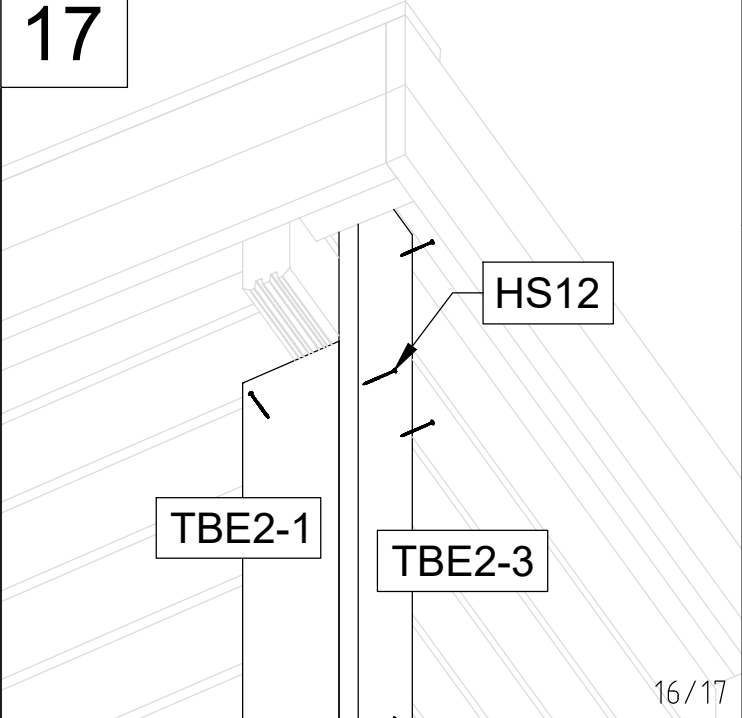

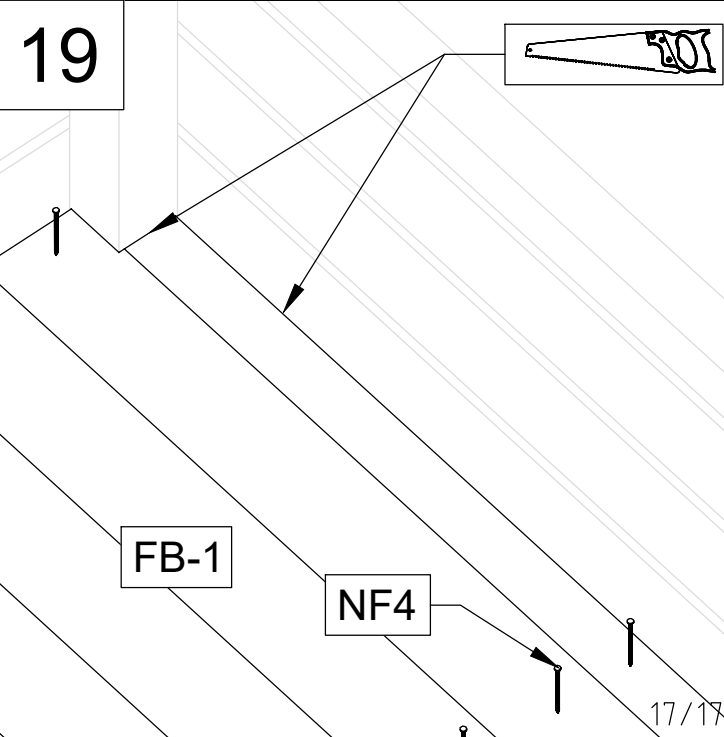
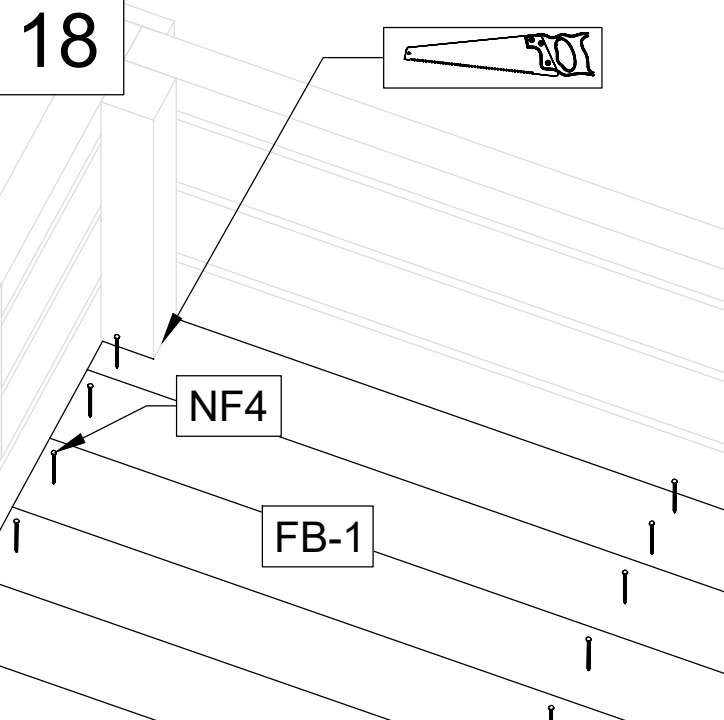
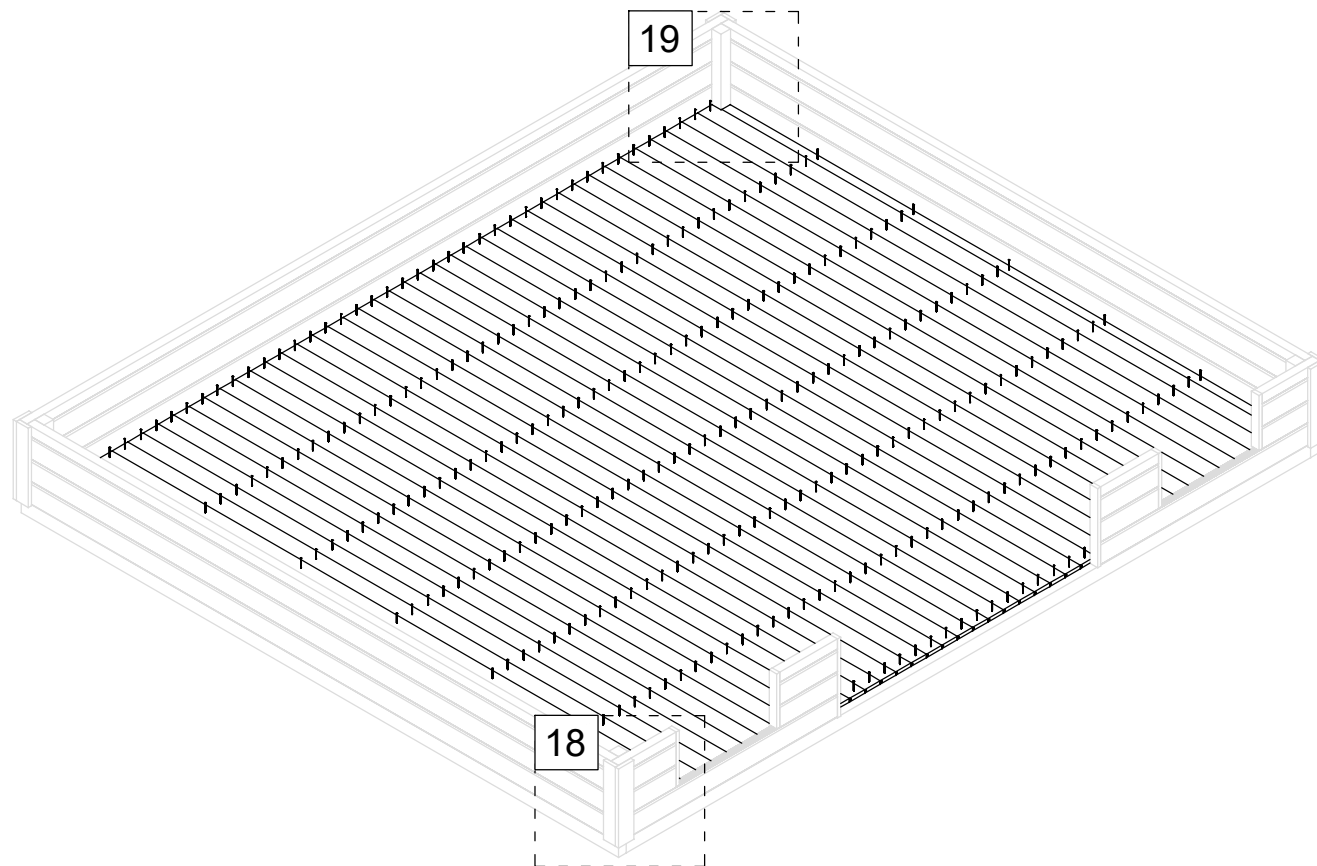



Pos	10.11.2017	Piece list - Stückliste - Liste des pièces - Elementi - Stuklijst - Tükitalabel 560x1780 AK.1.100.TPSP DGP+	1/1	Q	P (mm)	L (mm)
-----	------------	----------------------------------------------------------------------------------------------------------------	-----	---	-----------	-----------

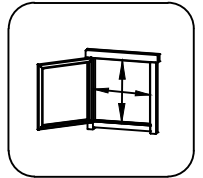
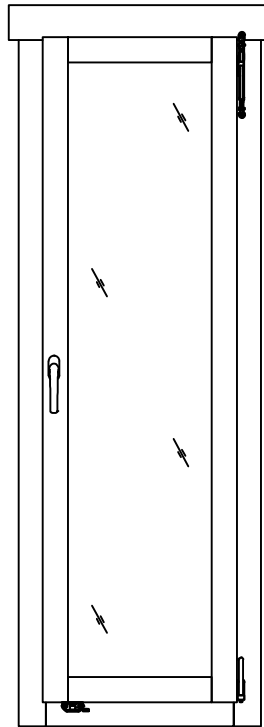



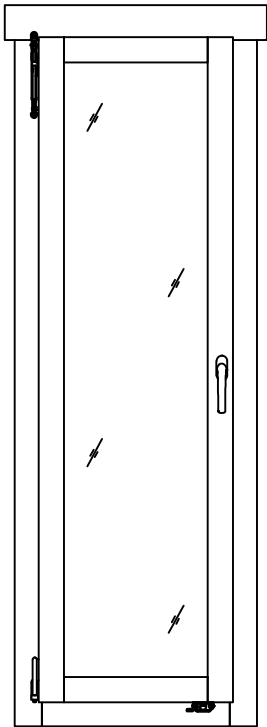
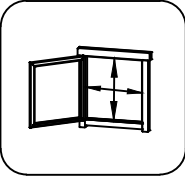

Glass size - Glasgröße - Taille de la vitre - Misura del vetro - Glas afmeting - Klaasi mõõt: 390x1602 mm

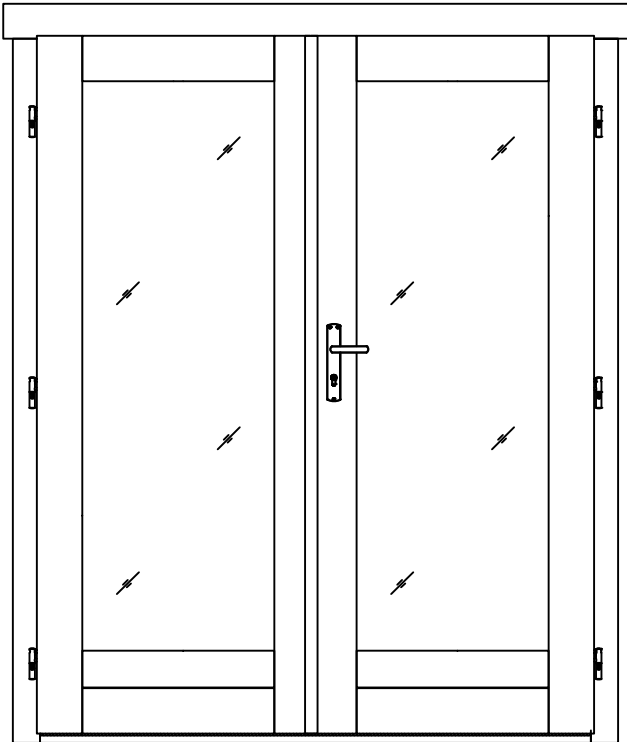
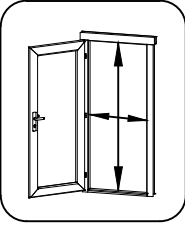
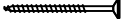
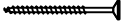
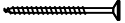

460x1684 mm

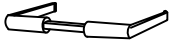
FS2	Window handle fittings - Fenstergriff - Poignee de fenetre - Maniglia c/ferramenta - Raamhendel -/grendel -/klink - Aknalink		1		
-----	---------------------------------------------------------------------------------------------------------------------------------	---------------------------------------------------------------------------------------	---	--	--

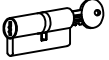
Pos	10.11.2017 Piece list - Stückliste - Liste des pièces - Elementi - Stuklijst - Tükitalabel 560x1780 AK.1.100.TPSV DGP+	1/1	Q	P (mm)	L (mm)
	<p data-bbox="256 152 1286 181">Glass size - Glasgröße - Taille de la vitre - Misura del vetro - Glas afmeting - Klaasi mõõt: 390x1602 mm</p>   <p data-bbox="1366 349 1493 378">460x1684 mm</p>				
FS2	<p data-bbox="261 2130 1023 2186">Window handle fittings - Fenstergriff - Poignee de fenetre - Maniglia c/ferramenta - Raamhendel -/grendel -/klink - Aknalink</p>		1		

Pos	Piece list - Stückliste - Liste des pièces - Elementi - Stuklijst - Tükítabel 1494x1900 TUK.1.100.TPVP.MMj DGP+	1/1	Q	P (mm)	L (mm)
	<p>Glass size - Glasgröße - Taille de la vitre - Misura del vetro - Glas afmeting - Klaasi mõõt: 514x1536 mm</p>   <p>1394x1812 mm</p>				
HS4	Screw for door fillet - Schraube zur Befestigung Türleiste - Vis pour fixation baguette d'arrêt de porte - Viti per massellino della porta - Schroef voor deurlijst - Kruvi ukse kokkuvaltšiliistule		5	3x30	
HS16	Screw for door jamb - Schraube für Türrahmen - Vis de fixation partie haute avec montants du cadre de porte - Viti x fissaggio montanti porte - Schroef voor deurkozijn - Kruvi ukse lengile		4	5x90	
HS25	Screw for doorstep - Schrauben für Swelle - Vis pour fixation barre de seuil - Vite per soglia della porta - Schroef voor deurdorpel - Kruvi lävepakule		3	4.5x65	
MH	Male bolt hinge for door - Türband - Partie male de paumelle de porte - Cerniera anube x porta - Scharnier bout - Reguleeritav polthing isane		6	14x80	
HC	Covers for door hinges - Schutzkappe für Türband - Couverture de paumelle de porte - Copertura delle cerniere della porta - Afdek kap voor deurscharnier - Reguleeritava polthinge kate		12		
TL4	Door handle fittings - Türgriff - Poignée de porte - Maniglie - Deurhendel / klink - Ukse käepide		1		
TL5	Set of door lock covers - Schlossblenden - Set de garnitures de porte - Copertura serrature - Slot sluitplaat set - Ukse lukuplaat		1		
	Cylinder lock - Zylinderschloss - Barillet de porte - Serratura - Cylinder slot - Ukse lukusüdamik		1	30x35	
	Striker for barrel bolt - Hülse für Grendelriegel - Gache au sol du targette - Boccola per fermo della porta - Huls voor vergrendelingsschuif - Vasturaud ukse servariivile		2		