

Name	Portland 220x420/44						
Zeichnung/Drawing	3D						
Maßstab/Scale	1:40	Profil/Profile	4.4x13.5	Druck auf/ Print on	A4	Datum/Date	17.02.2022

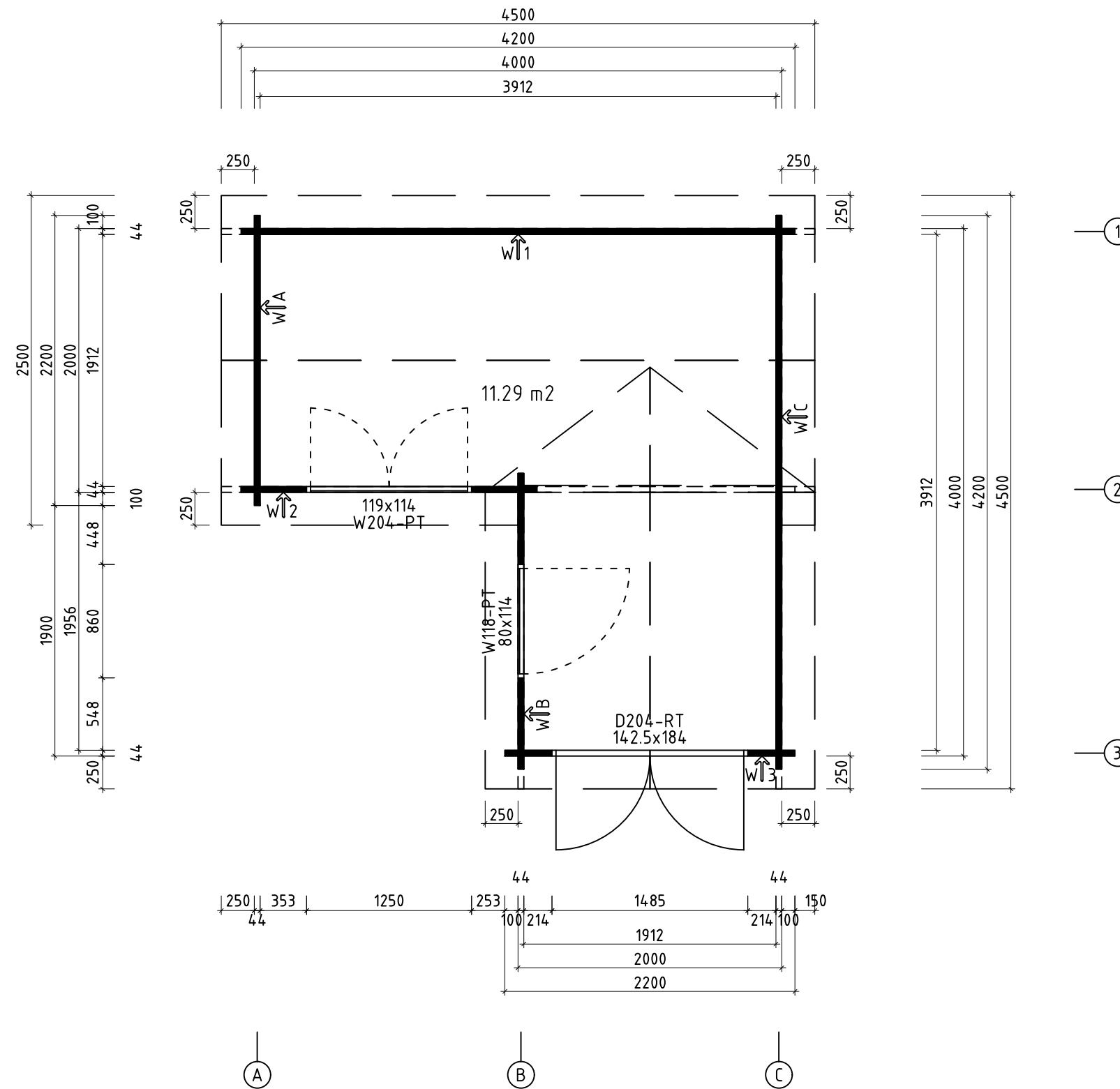

Q4 - Qualitätsklasse für Fenster und Türen/
Quality class for windows and doors

* Fenster und Türen sind mit Sprossen/
Windows and doors are with muntins

Name	Portland 220x420/44		
Zeichnung/Drawing	Grundplan; Plan		
Maßstab/Scale	1:40	Profil/Profile	4.4x13.5
Druck auf/ Print on	A3	Datum/Date	17.02.2022

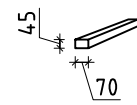
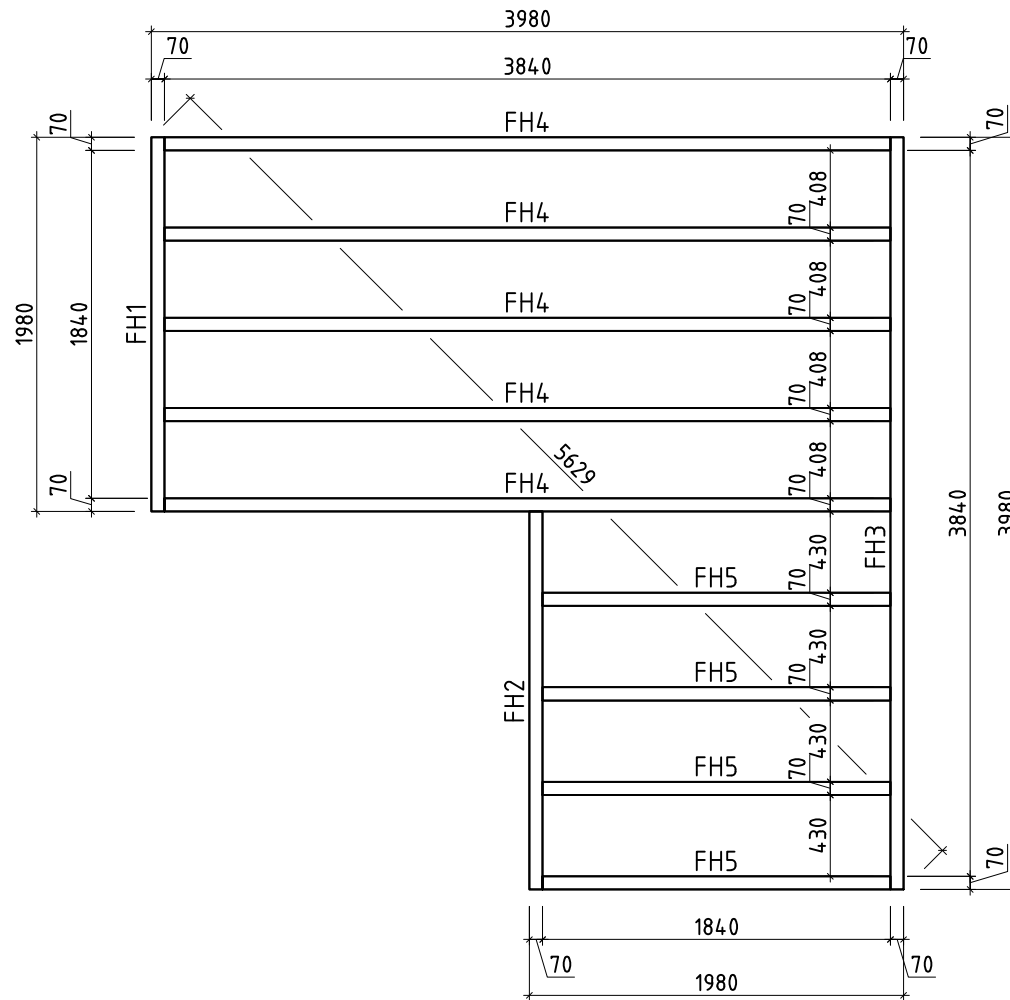

Name		Portland 220x420/44	
Zeichnung/Drawing		Lagerholzplan; Foundation beams	
Maßstab/Scale	1:40	Profil/Profile	4.4x13.5
Druck auf/Print on	A4	Datum/Date	17.02.2022

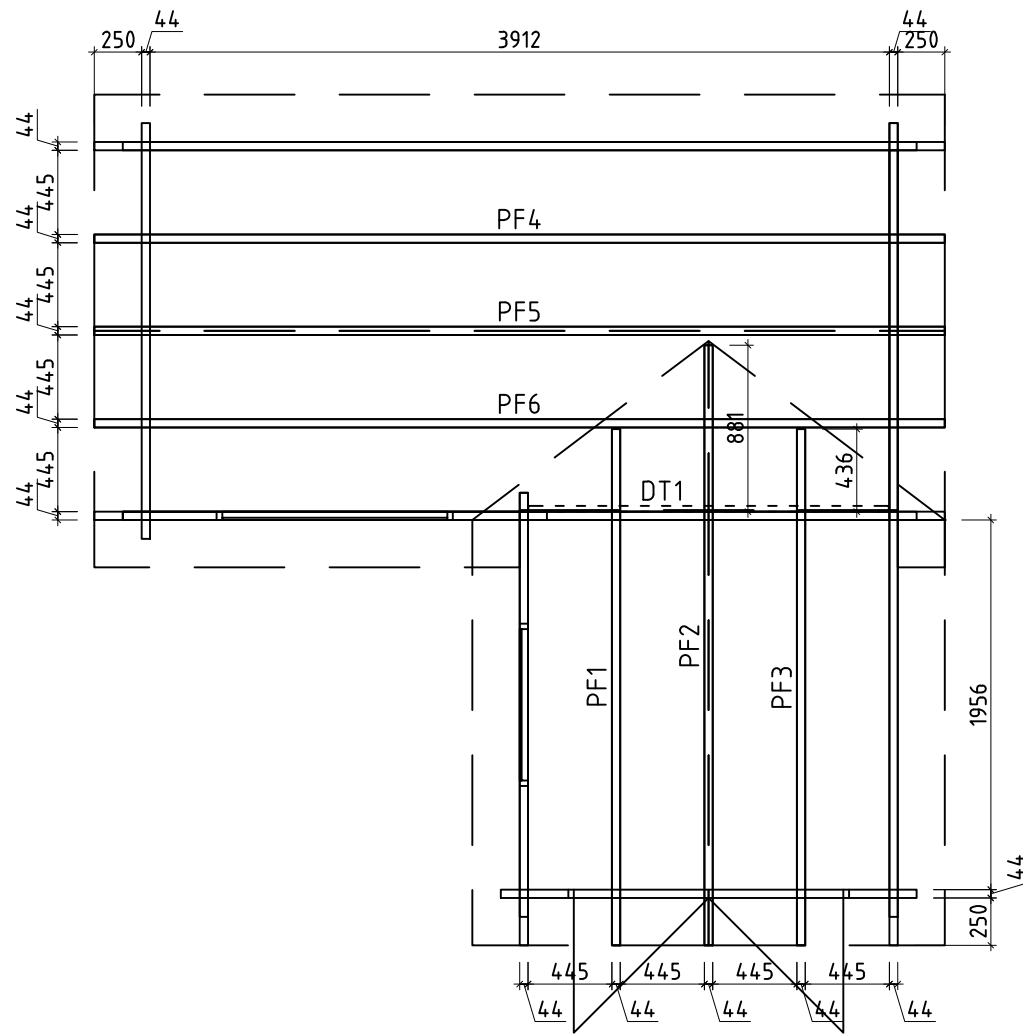

Name		Portland 220x420/44	
Zeichnung/Drawing		Pfetten; Purlins	
Maßstab/Scale	1:40	Profil/Profile	4.4x13.5
Druck auf/ Print on	A4	Datum/Date	17.02.2022

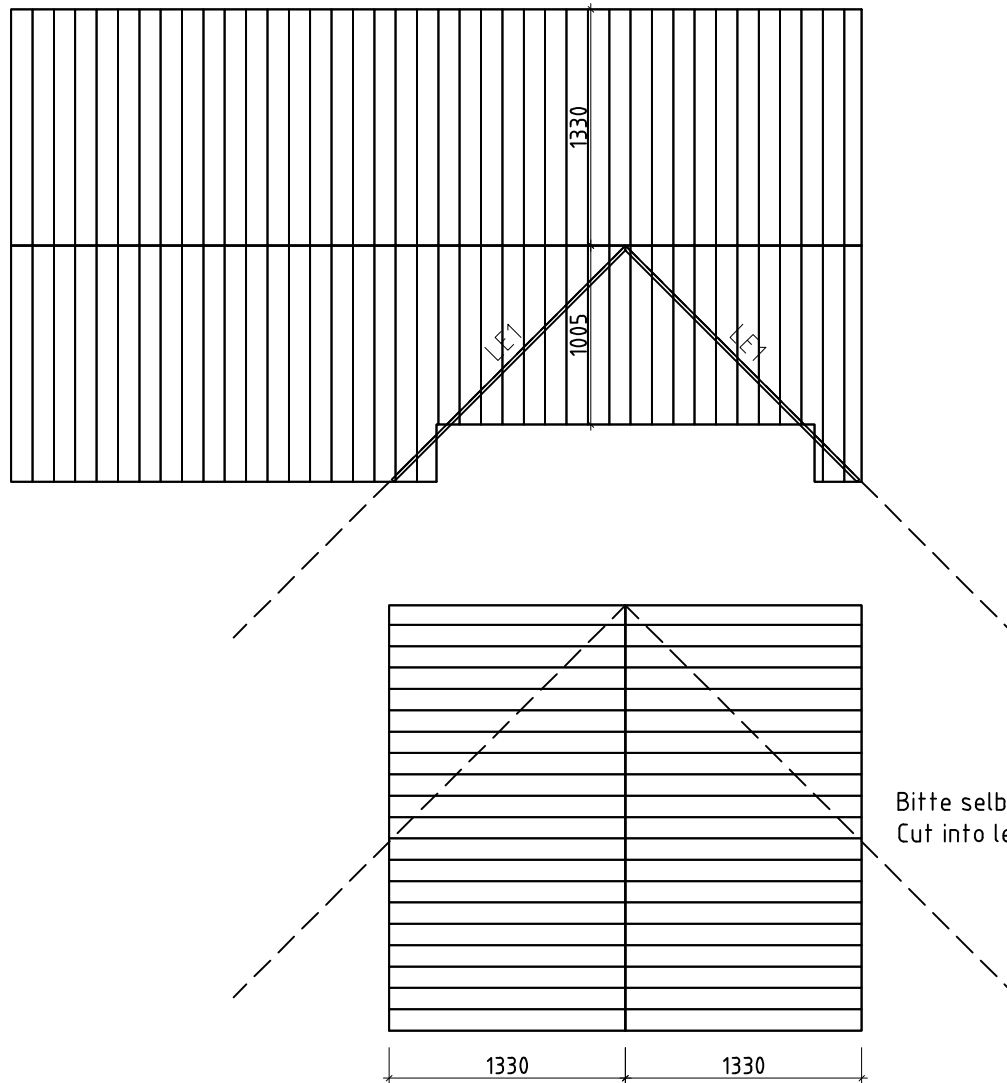

Bitte selber anpassen/
Cut into length on site

Name				Portland 220x420/44			
Zeichnung/Drawing				Dachbretter; Roof boards			
Maßstab/Scale	1:40	Profil/Profile	4.4x13.5	Druck auf/ Print on	A4	Datum/Date	17.02.2022

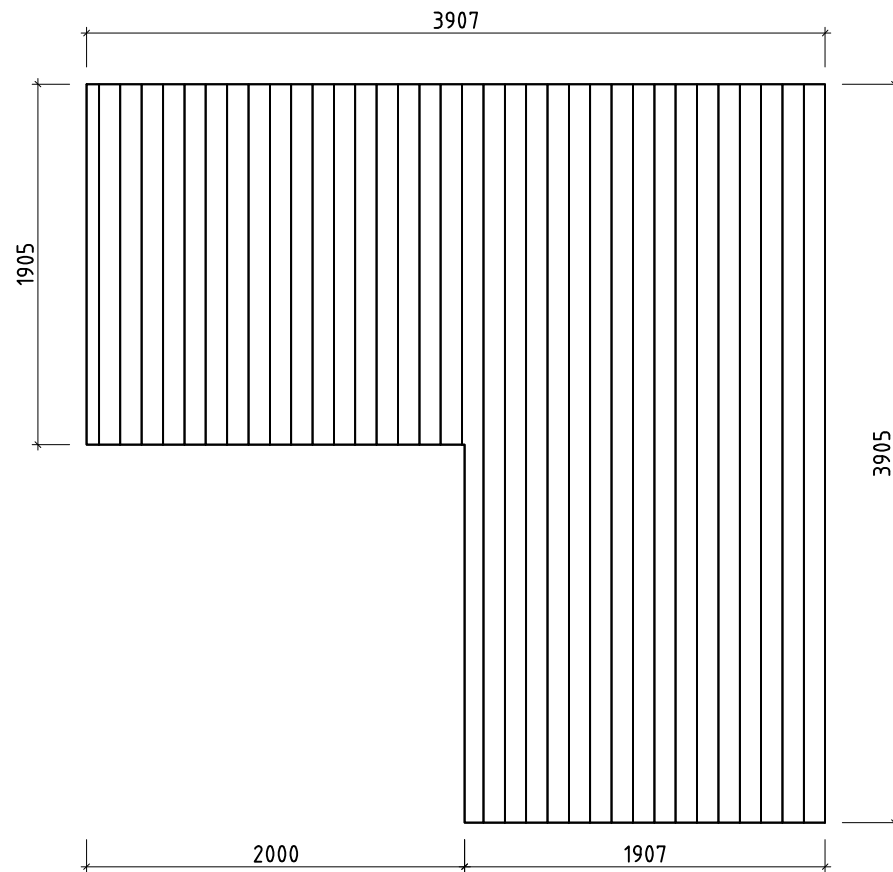

Name		Portland 220x420/44		
Zeichnung/Drawing		Fussbodenbretter; Floor boards		
Maßstab/Scale	1:40	Profil/Profile	4.4x13.5	Druck auf/ Print on
			A4	Datum/Date
				17.02.2022

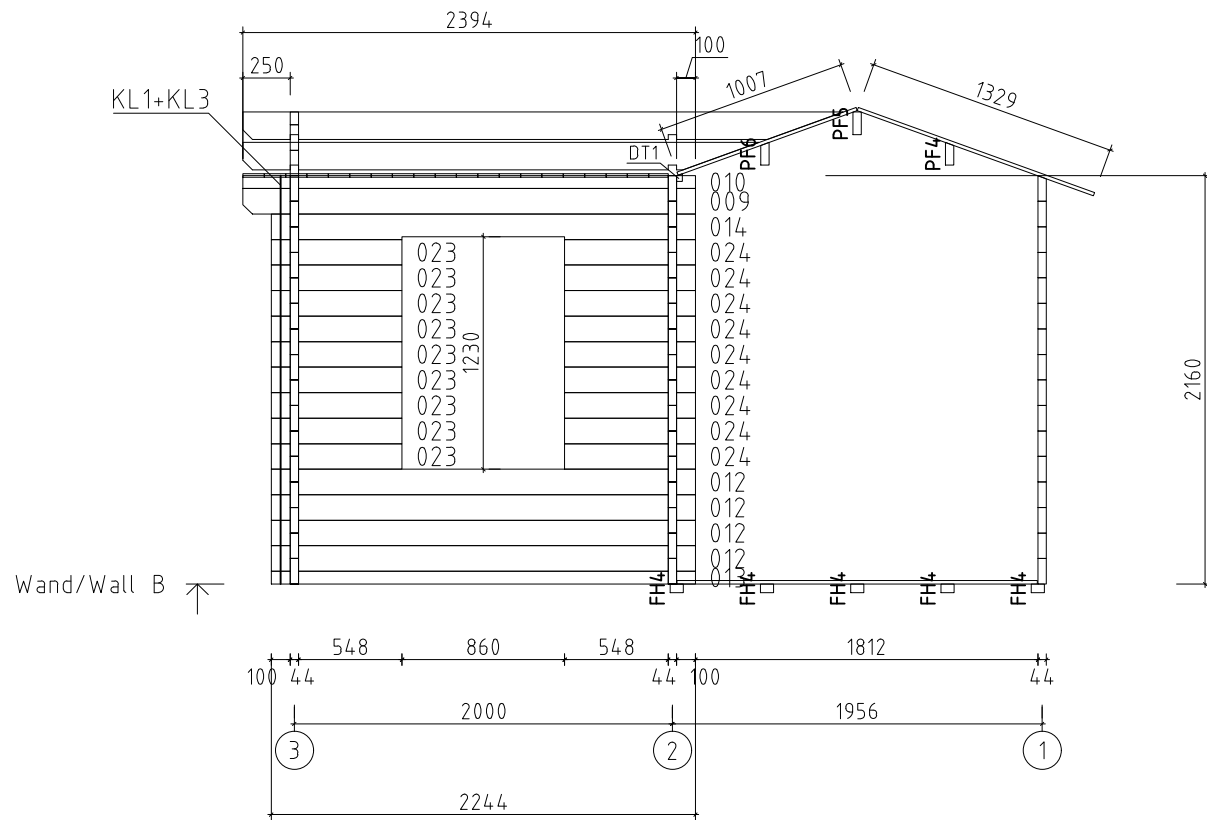



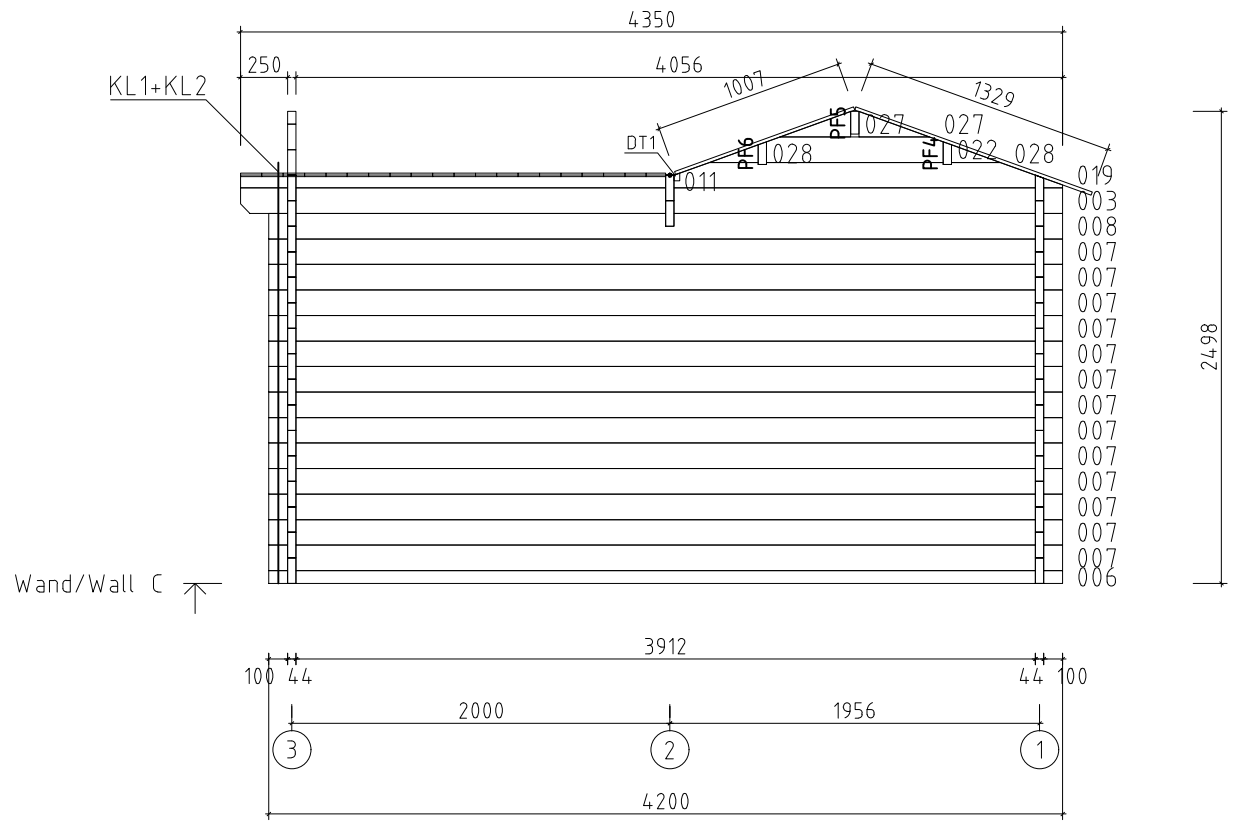

Name				Portland 220x420/44			
Zeichnung/Drawing				WAND/WALL B			
Maßstab/Scale	1:40	Profil/Profile	4.4x13.5	Druck auf/ Print on	A4	Datum/Date	17.02.2022

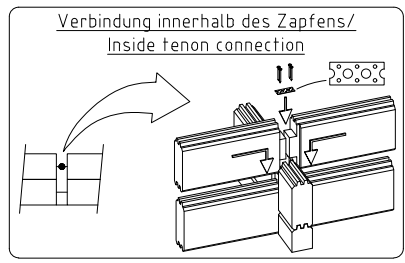



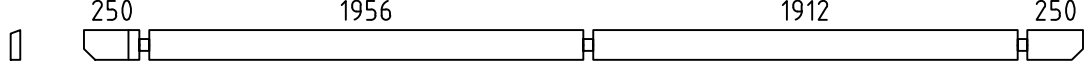
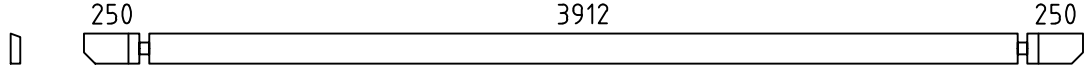
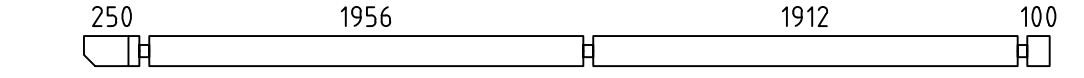
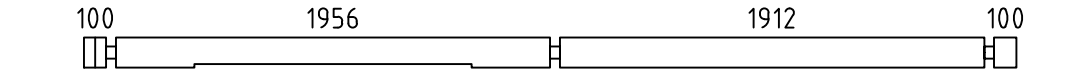
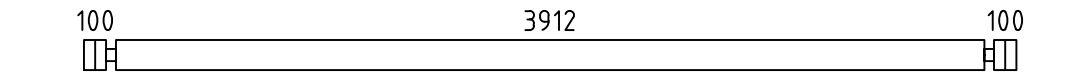
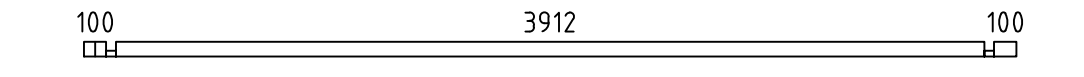
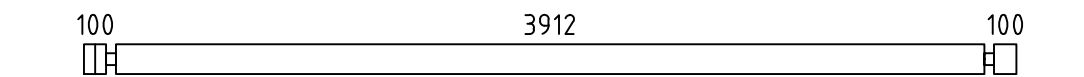

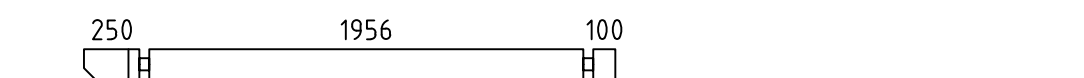
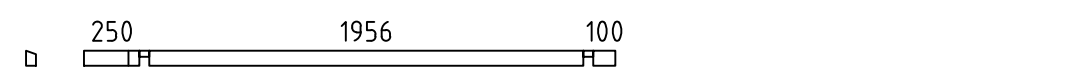
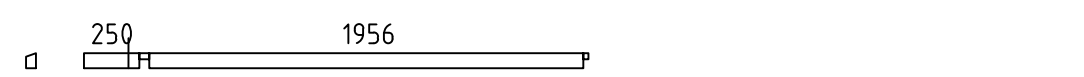
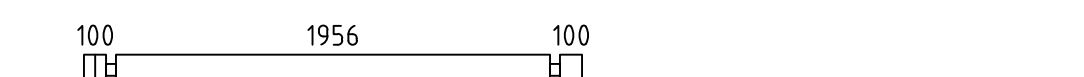
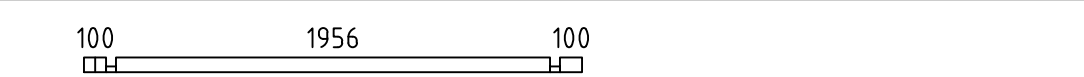
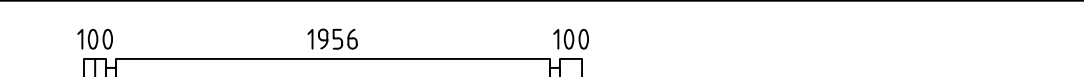

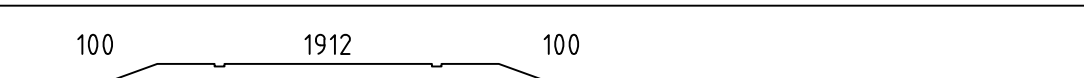
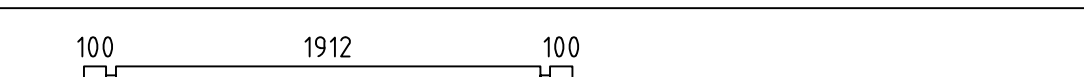
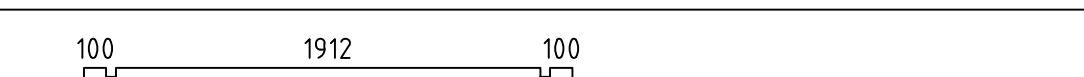
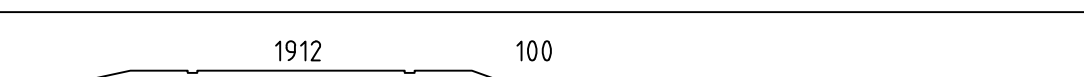
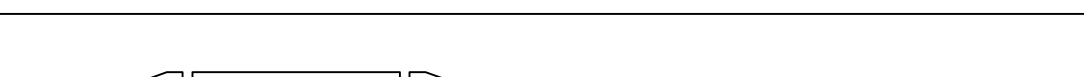
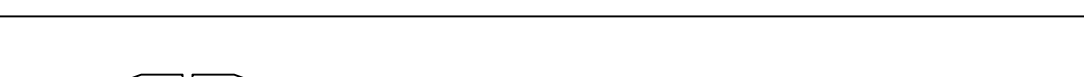
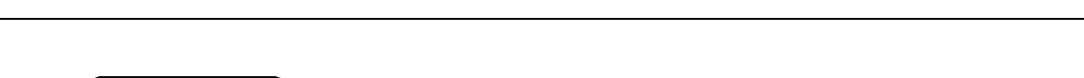
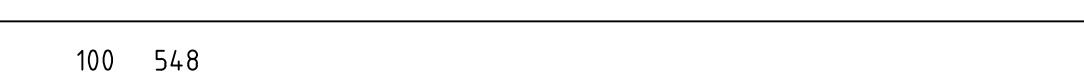
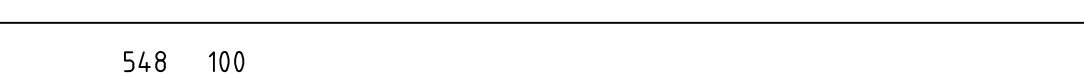
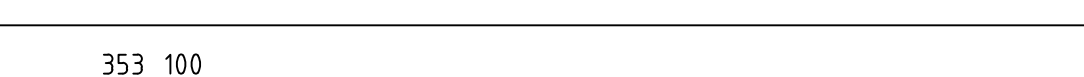

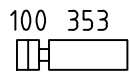



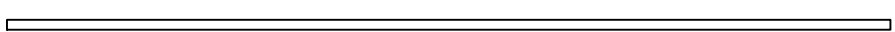

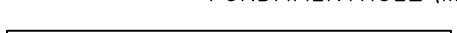
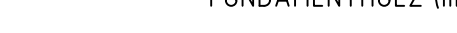
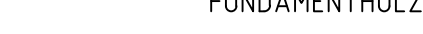
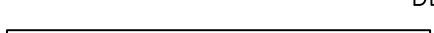

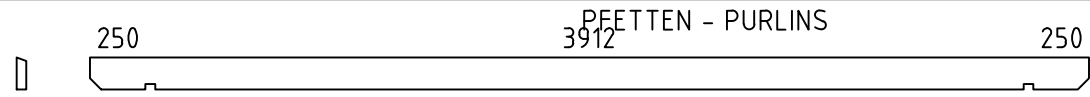
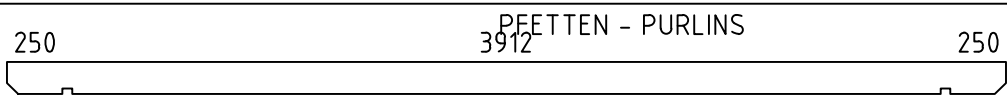
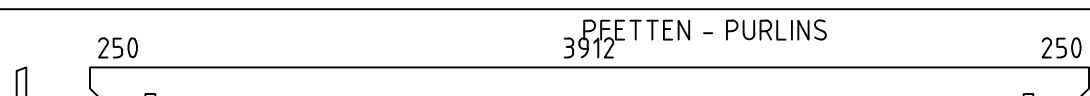
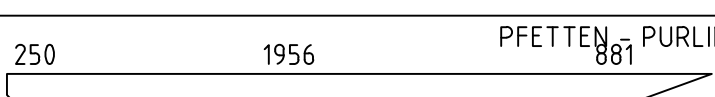
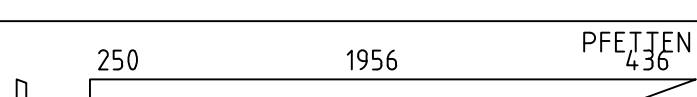
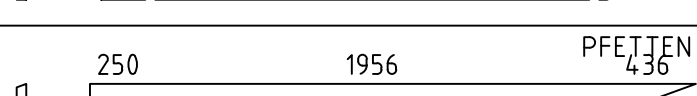
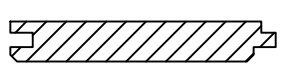

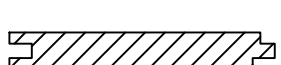



Wand/Wall C

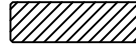



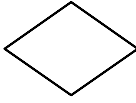
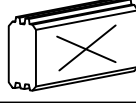

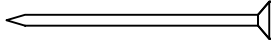
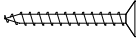
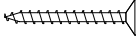
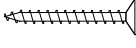
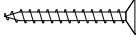
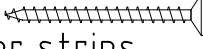
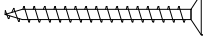
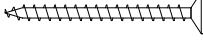
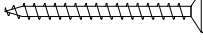
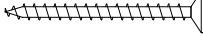
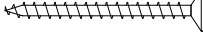
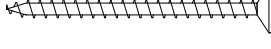
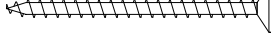
Name		Portland 220x420/44	
Zeichnung/Drawing		WAND/WALL C	
Maßstab/Scale	1:40	Profil/Profile	4.4x13.5
Druck auf/ Print on	A4	Datum/Date	17.02.2022

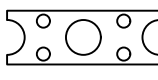
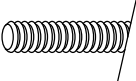
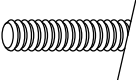
Pos	Teileliste/Specification Portland 220x420/44	Stck Pcs.	Profil Profile (mm)	Länge Length (mm)
001		1	44x135	4500
002		1	44x135	4500
003		1	44x135	4350
004		1	44x135	4200
005		15	44x135	4200
006		1	44x68	4200
007		13	44x135	4200
008		1	44x135	4200
009		1	44x135	2394
010		1	44x68	2394
011		1	44x68	2272
012		9	44x135	2244
013		1	44x68	2244
014		1	44x135	2244
015		1	44x135	2200
016		1	44x135	2200
017	 ✓	30	44x135	2200
018		1	44x68	2200
019		1	44x135	2078
020		2	44x135	1912
021		2	44x135	934
022		2	44x135	934
023		9	44x135	692
024		9	44x135	692
025		9	44x135	497
Kood	Portland 220x420/44	Materjal		Leht 1/4

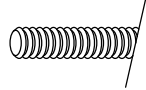
Pos	Teileliste/Specification Portland 220x420/44		Stck Pcs.	Profil Profile (mm)	Länge Length (mm)	
026			9	44x135	497	
027			4	44x135	374	
028			4	44x93	258	
029			4	44x67	187	
030			4	44x26	71	
FH3	FUNDAMENTHOLZ (imprägniert) - FOUNDATION BEAM (impregnated) 		1	70x45	3980	
FH4	FUNDAMENTHOLZ (imprägniert) - FOUNDATION BEAM (impregnated) 		5	70x45	3840	
FH2	FUNDAMENTHOLZ (imprägniert) - FOUNDATION BEAM (impregnated) 		1	70x45	2000	
FH1	FUNDAMENTHOLZ (imprägniert) - FOUNDATION BEAM (impregnated) 		1	70x45	1980	
FH5	FUNDAMENTHOLZ (imprägniert) - FOUNDATION BEAM (impregnated) 		4	70x45	1840	
DT1	DECKENTRÄGER - COVER CARRIER 		✓	1	30x40	1907
LE1	LEISTE - LATH 		✓	2	18x40	1750
PF4		PFETTEN - PURLINS	1	44x145	4500	
PF5		PFETTEN - PURLINS	1	44x145	4500	
PF6		PFETTEN - PURLINS	1	44x145	4500	
PF2		PFETTEN - PURLINS	1	44x145	3175	
PF1		PFETTEN - PURLINS	1	44x145	2730	
PF3		PFETTEN - PURLINS	1	44x145	2730	
	DACHBRETTER - ROOF BOARDS		✓	121+2	113x18	1330
	DACHBRETTER - ROOF BOARDS		17	113x18	1005	
	FUSSBODENBRETTER - FLOOR BOARDS		17+1	113x18	3905	
	FUSSBODENBRETTER - FLOOR BOARDS		18	113x18	1905	
	DECKENLEISTEN - CEILING STRIPS		✓		15x28	41,0 lfm/rm
	FUSSBODENLEISTEN - FLOOR STRIPS		✓		18x40	17,0 lfm/rm
G02-1	GIEBELBRETTER - GABLE BOARDS 18x120	19,9° 	✓	6	18x120	1410
Kood	Portland 220x420/44		Materjal		Leht 2/4	

Pos	Teileliste/Specification Portland 220x420/44		Stck Pcs.	Profil Profile (mm)	Länge Length (mm)
G06-1	GIEBELDECKLEISTEN - GABLE COVER STRIPS 18x58	 ✓	6	18x58	1410
T01-1	TRAUFENBRETTER - EAVES BOARDS 18x95		2	18x95	2250
T01-2	TRAUFENBRETTER - EAVES BOARDS 18x95	 ✓	1	18x95	2750
T01-3	TRAUFENBRETTER - EAVES BOARDS 18x95		1	18x95	4500
T06-1	TRAUFENLEISTEN - EAVES STRIPS 18x40	 ✓		18x40	12,0 lfm/rm
GS	GIEBELSEGMENT - GABLE DIAMOND		3		
SH	SCHLAGHÖLZER - MOUNTING PIECES		3		
NG2 550	NÄGEL - NAILS 2.5x50 Dachbretter - Roof boards		828		
NG2 560	NÄGEL - NAILS 2.5x60 Fussbodenbretter - Floor boards		490		
SR3 030	Schrauben - Screws 3.0x30 Deckenleisten - Ceiling strips		82		
SR3 030	Schrauben - Screws 3.0x30 Fussbodenleisten - Floor strips		34		
SR3 030	Schrauben - Screws 3.0x30 Leiste - Lath		10		
SR3 030	Schrauben - Screws 3.0x30 Traufenleisten - Eaves strips		24		
SR37	Schrauben - Screws 3.5x45 Fenster- und Türleisten - Window and door strips		72		
SR3 545	Schrauben - Screws 3.5x45 Giebelbretter - Gable boards		18		
SR3 545	Schrauben - Screws 3.5x45 Giebeldeckleisten - Gable cover strips		18		
SR3 545	Schrauben - Screws 3.5x45 Giebelsegment - Gable diamond		6		
SR3 545	Schrauben - Screws 3.5x45 Traufenbretter - Eaves boards		26		
SR354 5-001	Schrauben - Screws 3.5x45 Verbindungsstreifen - Connecting strip		4		
SR44	Schrauben - Screws 4.0x60 Wasserleisten - Rain strips WL1		10		
SR4 060	Schrauben - Screws 4.0x60 Deckenträger - Cover Carrier		5		
SR5 0100	Schrauben - Screws 5.0x100 Fundamenthölzer - Foundation beams		48		
VS	Verbindungsstreifen für verbinden der Wandbohlen - Connecting strip for connecting the wall parts		1		
KL1	Gewindestange - Threaded Rod M8		5		2000
KL2	Gewindestange - Threaded Rod M8		1		258
Kood	Portland 220x420/44		Materjal		Leht 3/4

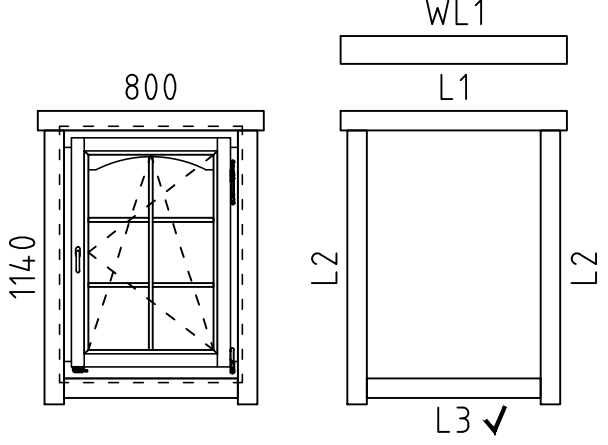
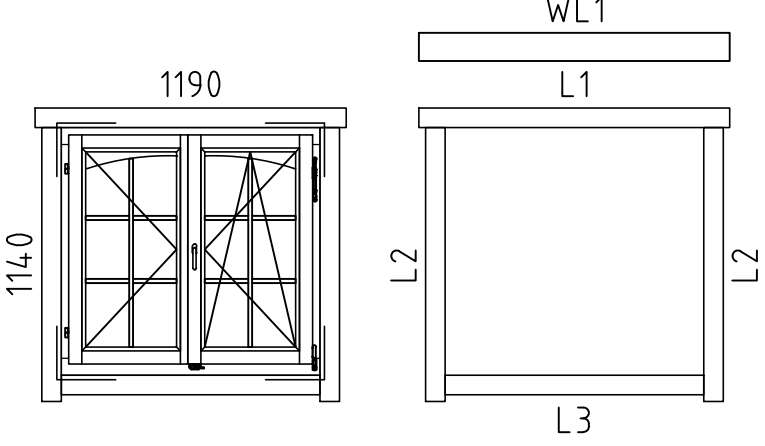
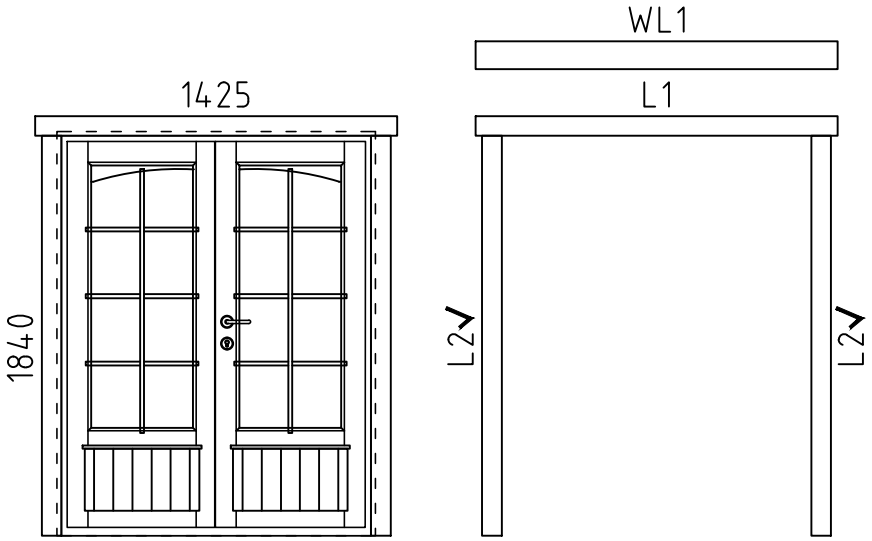
Pos	Teileliste/Specification Portland 220x420/44	Stck Pcs.	Profil Profile (mm)	Länge Length (mm)
KL3	Gewindestange - Threaded Rod M8 	4		190
KV M UT M8	Mutter - Nut M8 	10		
KV S EIB M8X25	U-Scheibe - Washer M8 Ø25 	10		
KV MU TJ M8	Befestigungsmutter - Fixing nut M8 	5		
	<p>FENSTER/WINDOW Q4 W4-S44P-A6T-08001140</p>  <p>W118-PT</p> <p>L1 18x90 L=1040mm 2x L2 18x90 L=1260mm 4x L3 18x90 L=800mm 2x ✓ WL1 36x129 L=1040mm 1x</p>	1		
	<p>FENSTER/WINDOW Q4 W4-D44P-G6T-11901140</p>  <p>W204-PT</p> <p>L1 18x90 L=1430mm 2 Stck. L2 18x90 L=1260mm 4 Stck. L3 18x90 L=1190mm 2 Stck. ✓ WL1 36x129 L=1430mm 1 Stck.</p>	1		
	<p>TÜR/DOOR Q4 D4-D44R-K8T-14251840</p>  <p>D204-RT</p> <p>L1 18x90 L=1665mm 2x L2 18x90 L=1840mm 4x ✓ WL1 36x129 L=1665mm 1x DIN rechts; right handed</p>	1		
	<p><u>Achtung!</u> Die Giebelbohlen können teilweise schon vormontiert sein! Bitte beachten - diese erscheinen nicht ganz so wie in der Teileliste beschrieben.</p>			
	<p><u>Notice!</u> The gable pieces can be partly pre-assembled! Please notice - those differ from the description given in the specification list.</p>			
	<p>✓ - Bitte selber anpassen (falls nötig)! / Cut into length on site (if needed)!</p>			
Kood	Portland 220x420/44	Materjal		Leht 4/4

Vihmaliist / Rain strip / Wasserleiste

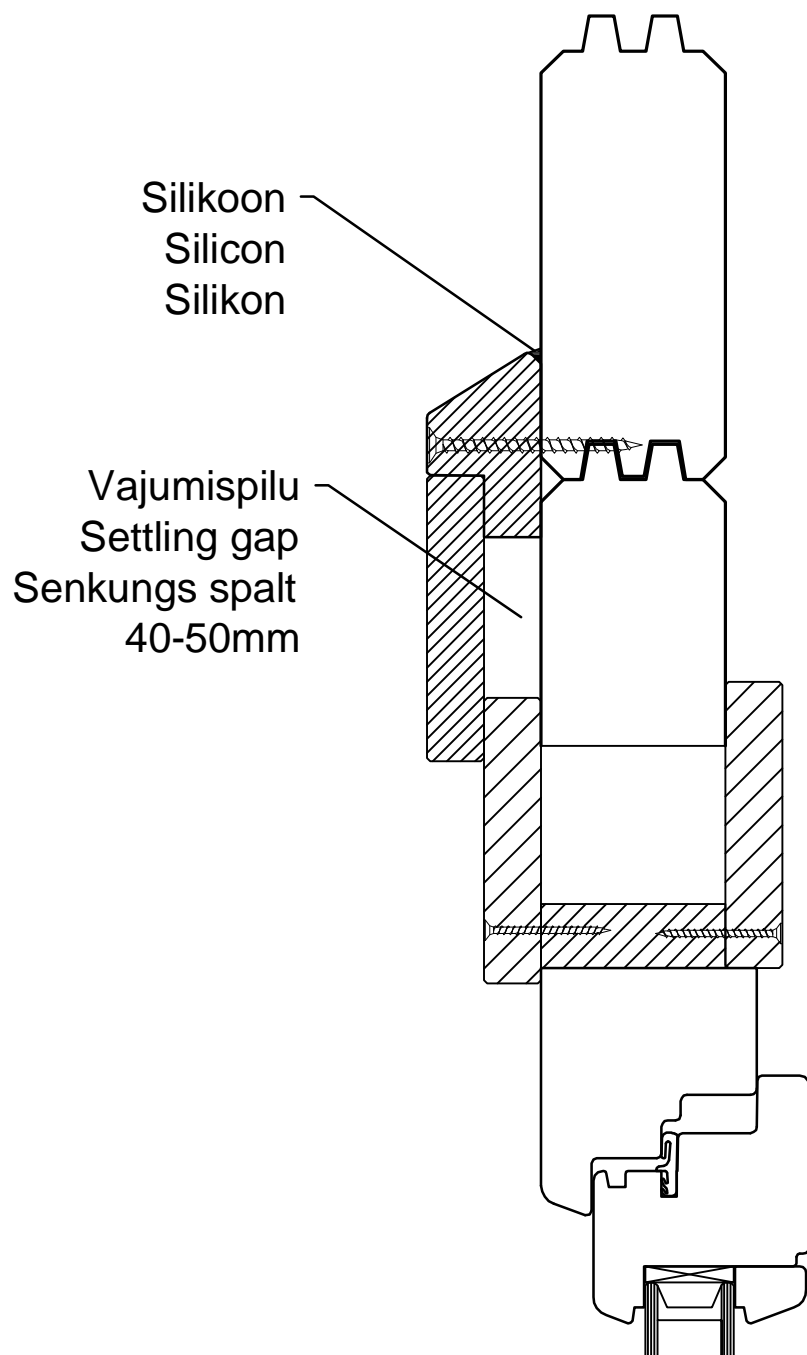

NB!

- Monteerida juhul kui ese on välja toodud maja spetsifikatsioonis!
- Install only if the item is listed in the house specification!
- Nur montieren wenn die Leiste in der Teileliste gezeigt ist!

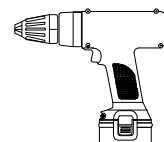

Aken	Q4-Q6	-	paigaldusjuhhis
Window	Q4-Q6	-	assembly instructions
Fenster	Q4-Q6	-	Montageanleitung

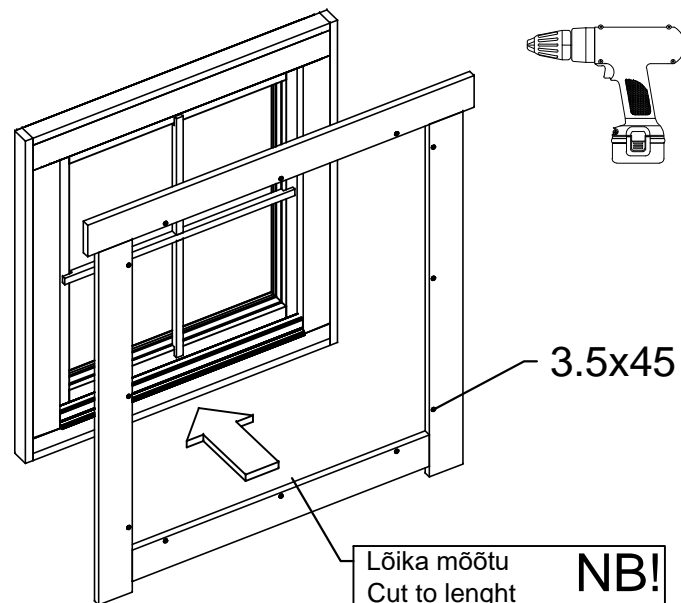
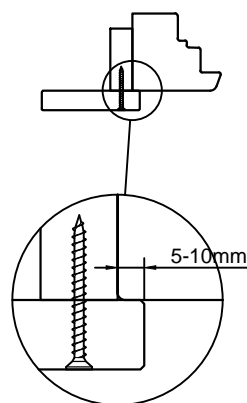
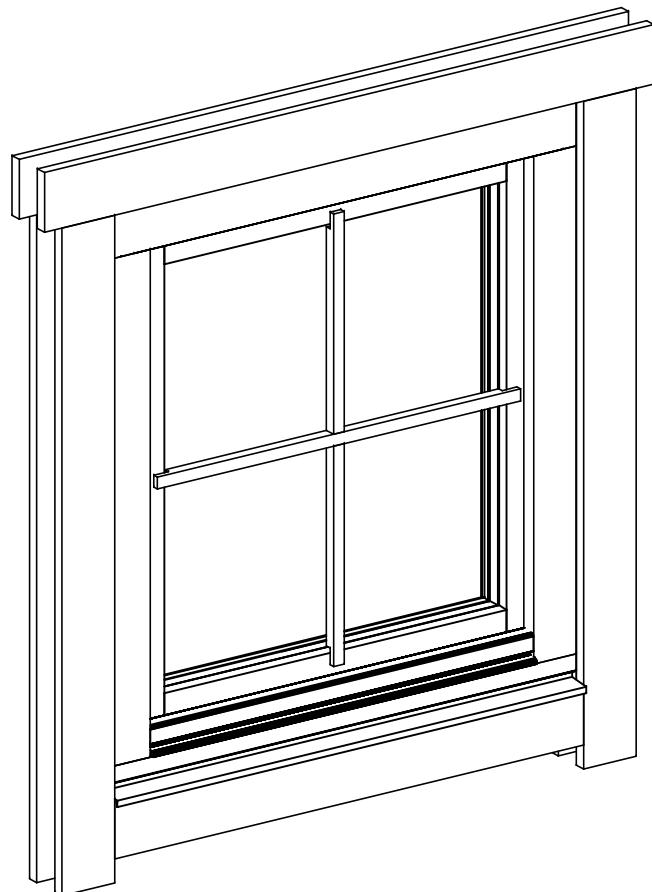

Lõika mõõtu
Cut to length
Absägen
- 10mm / -20mm

NB!

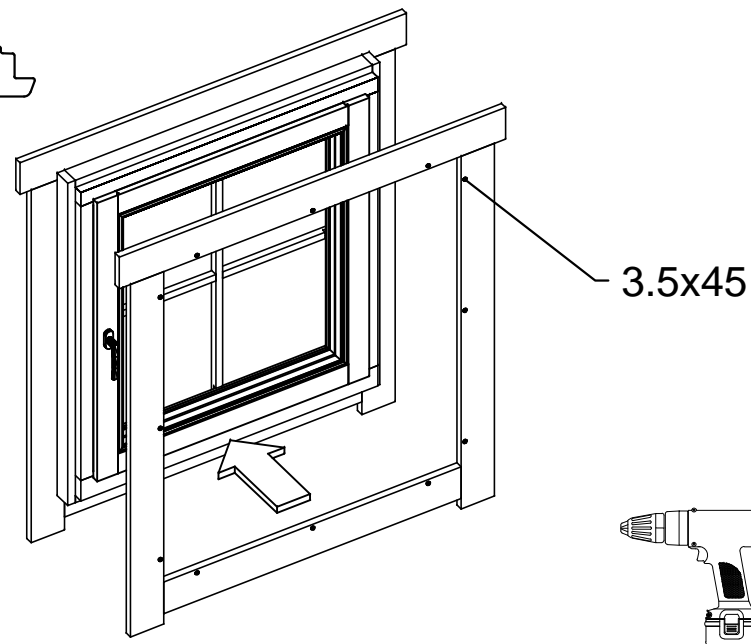
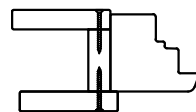

1

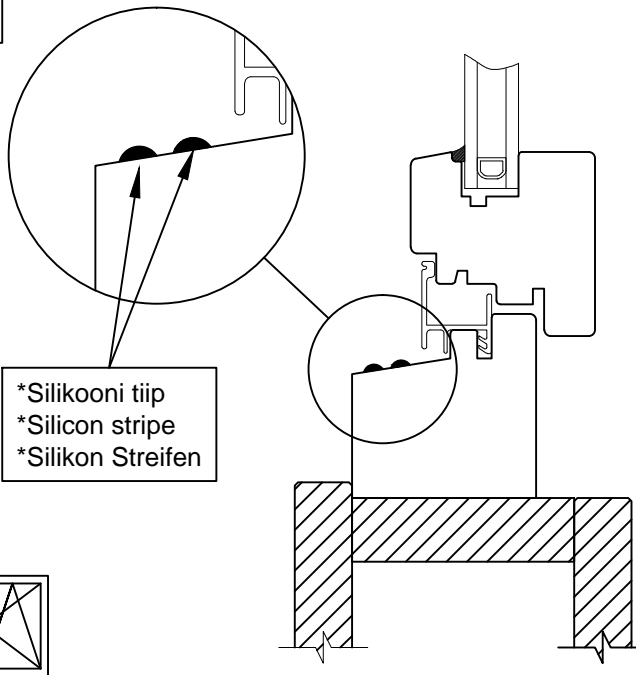

2

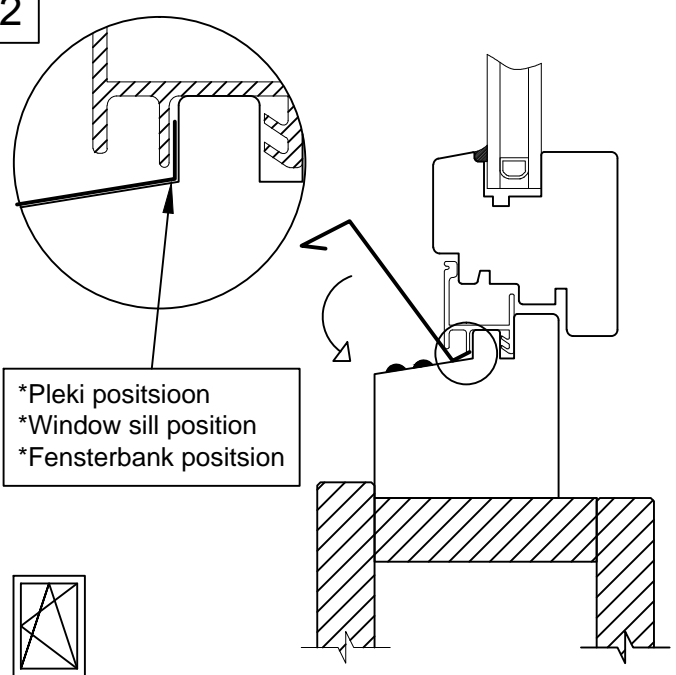

3

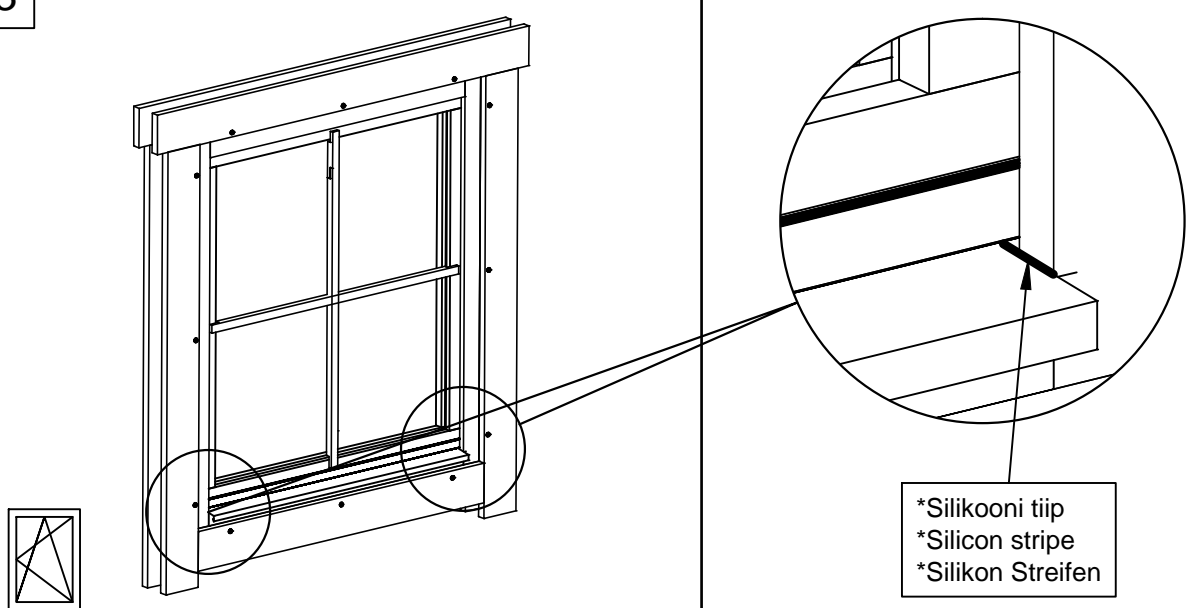

1

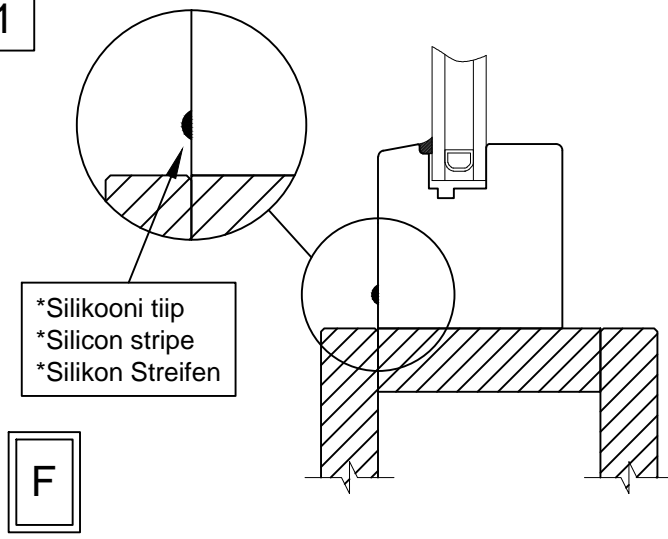

2

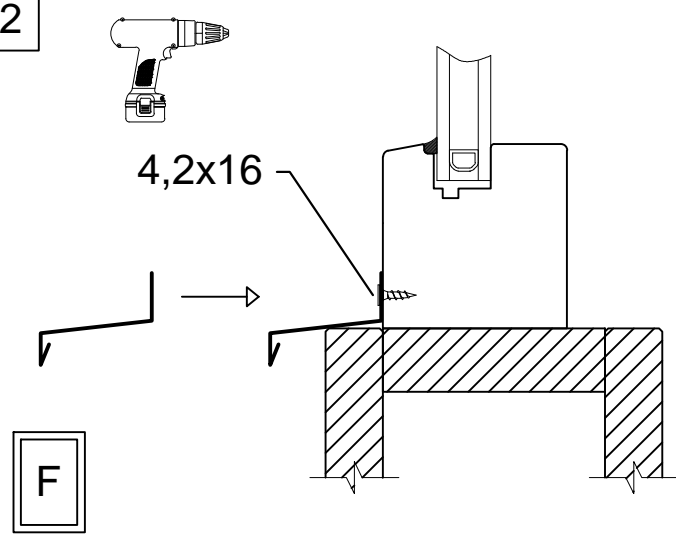

Ukse montaaž / Tür montage / Door assembly
(GH+ / SH)

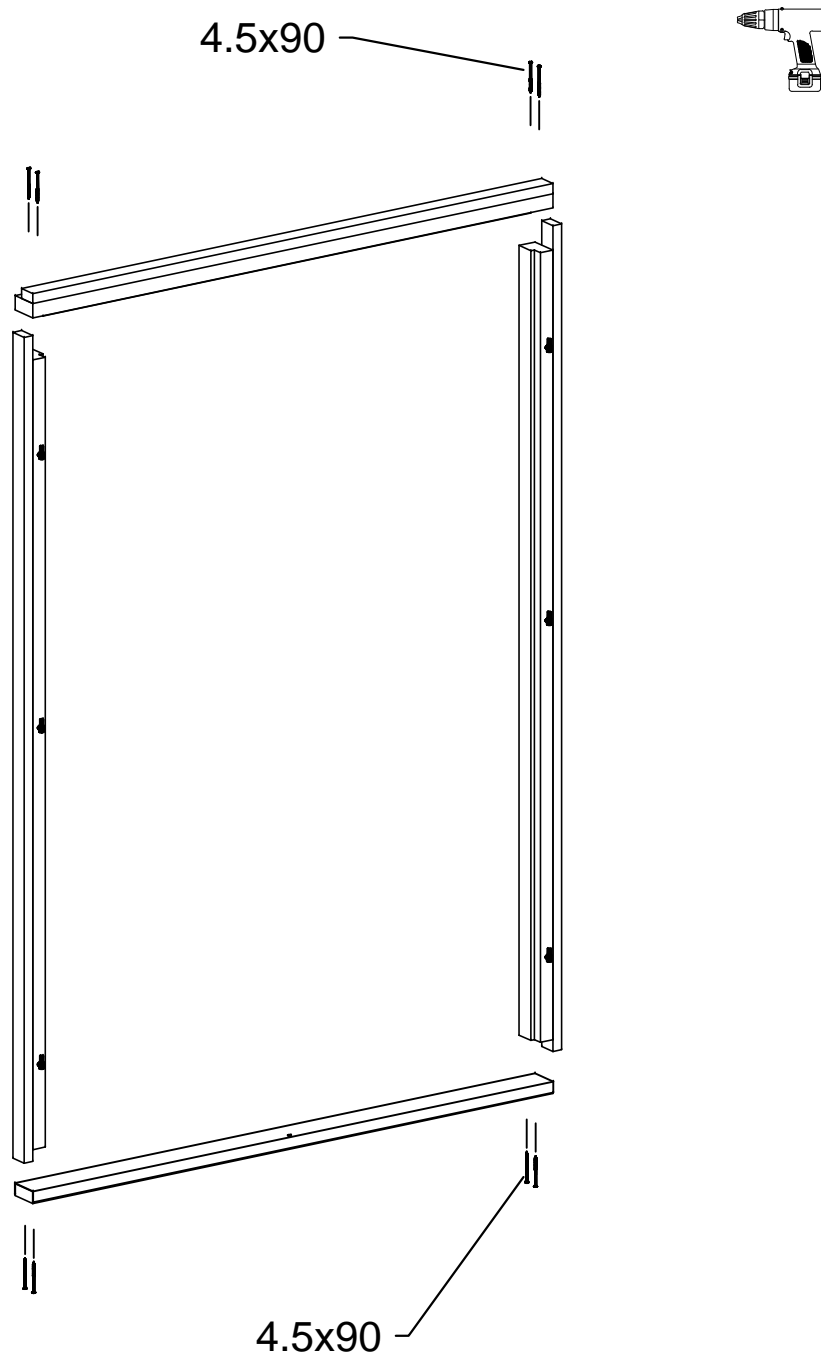
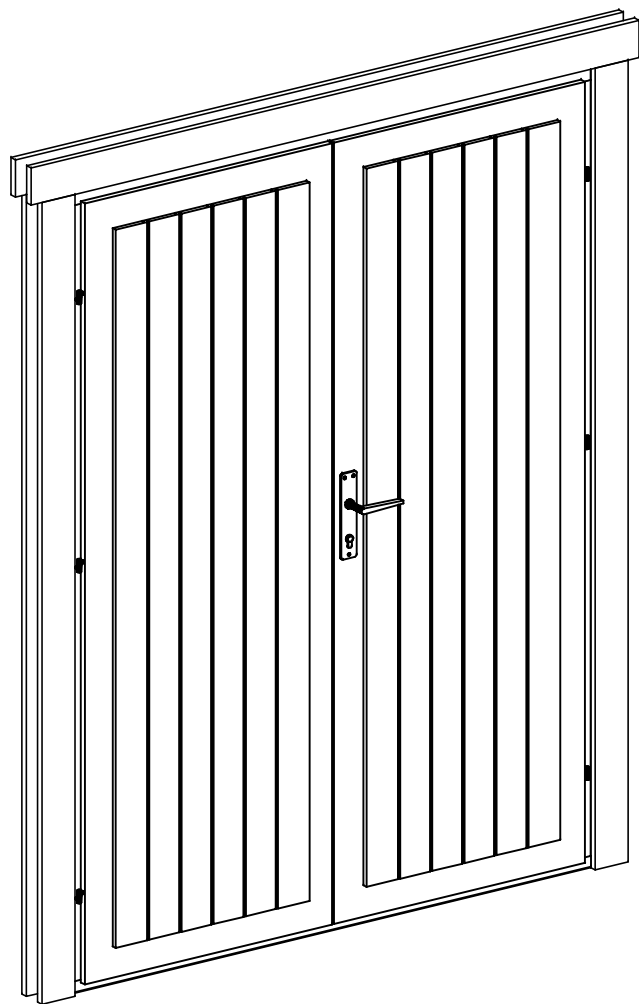

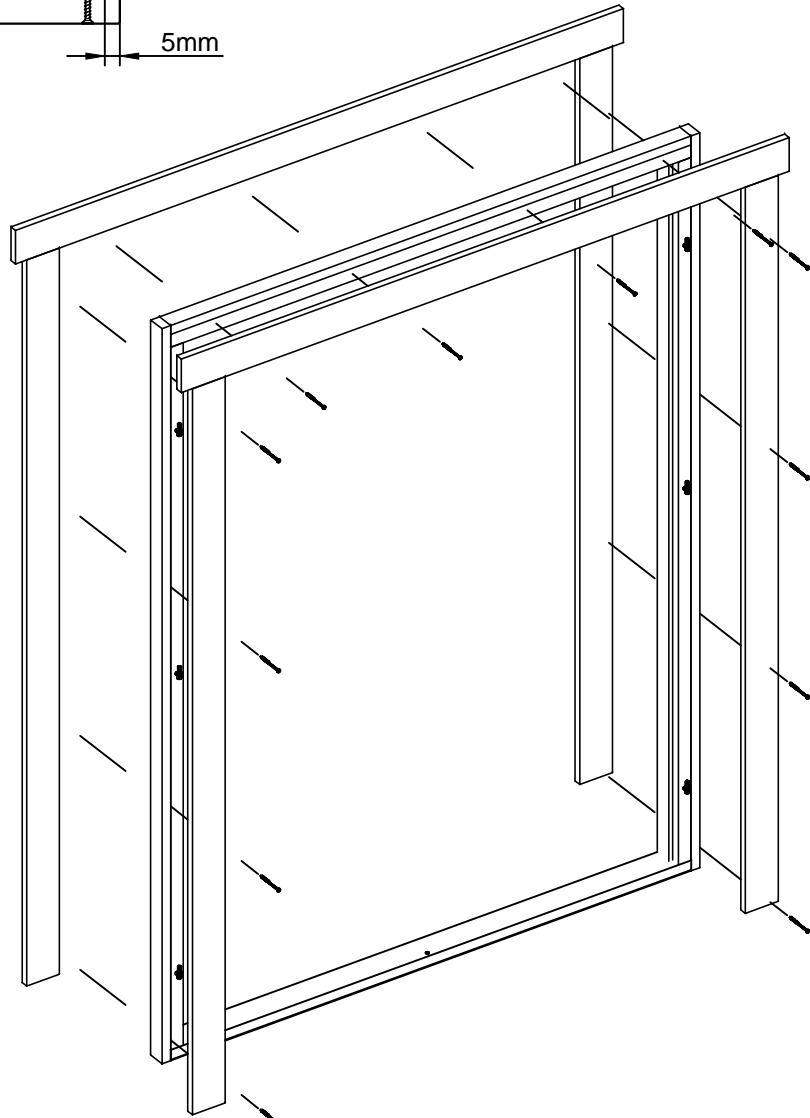
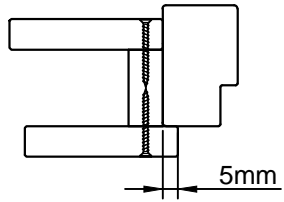

3.5x45

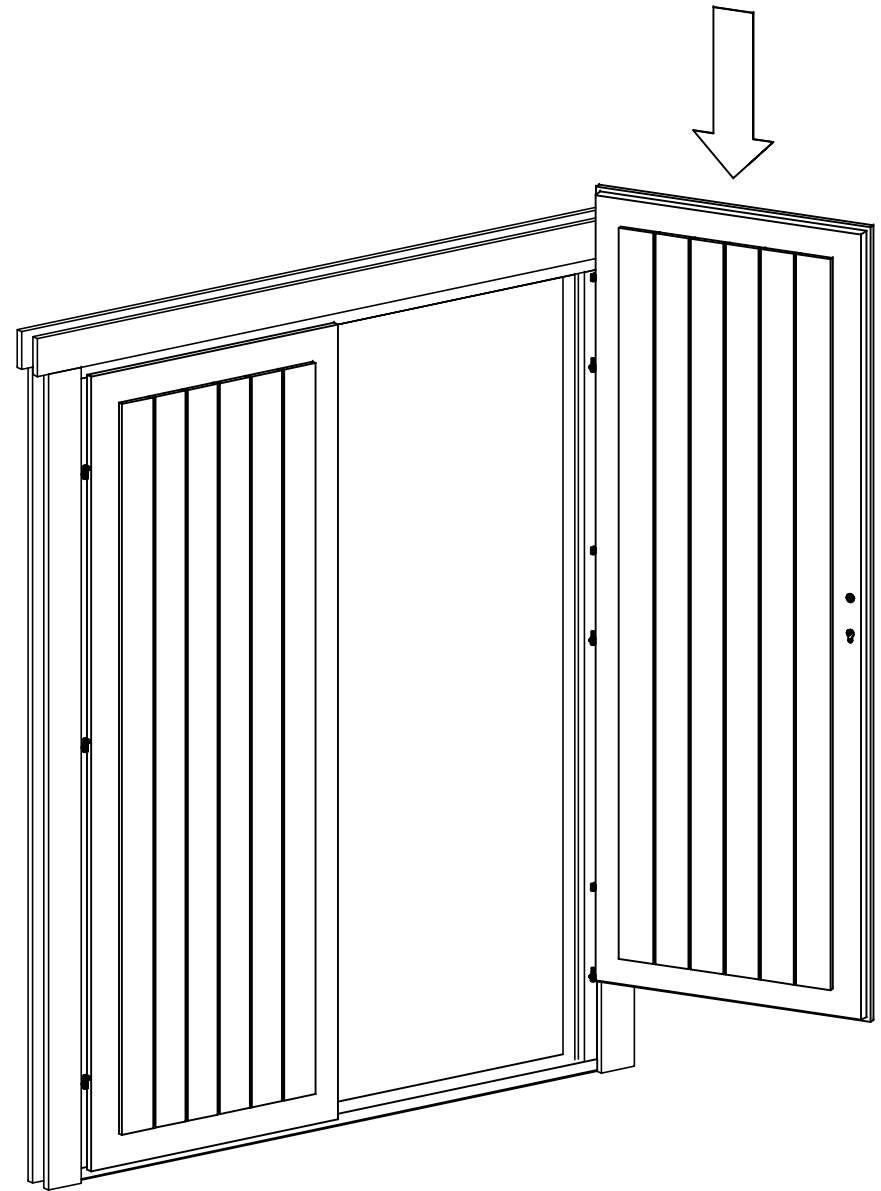

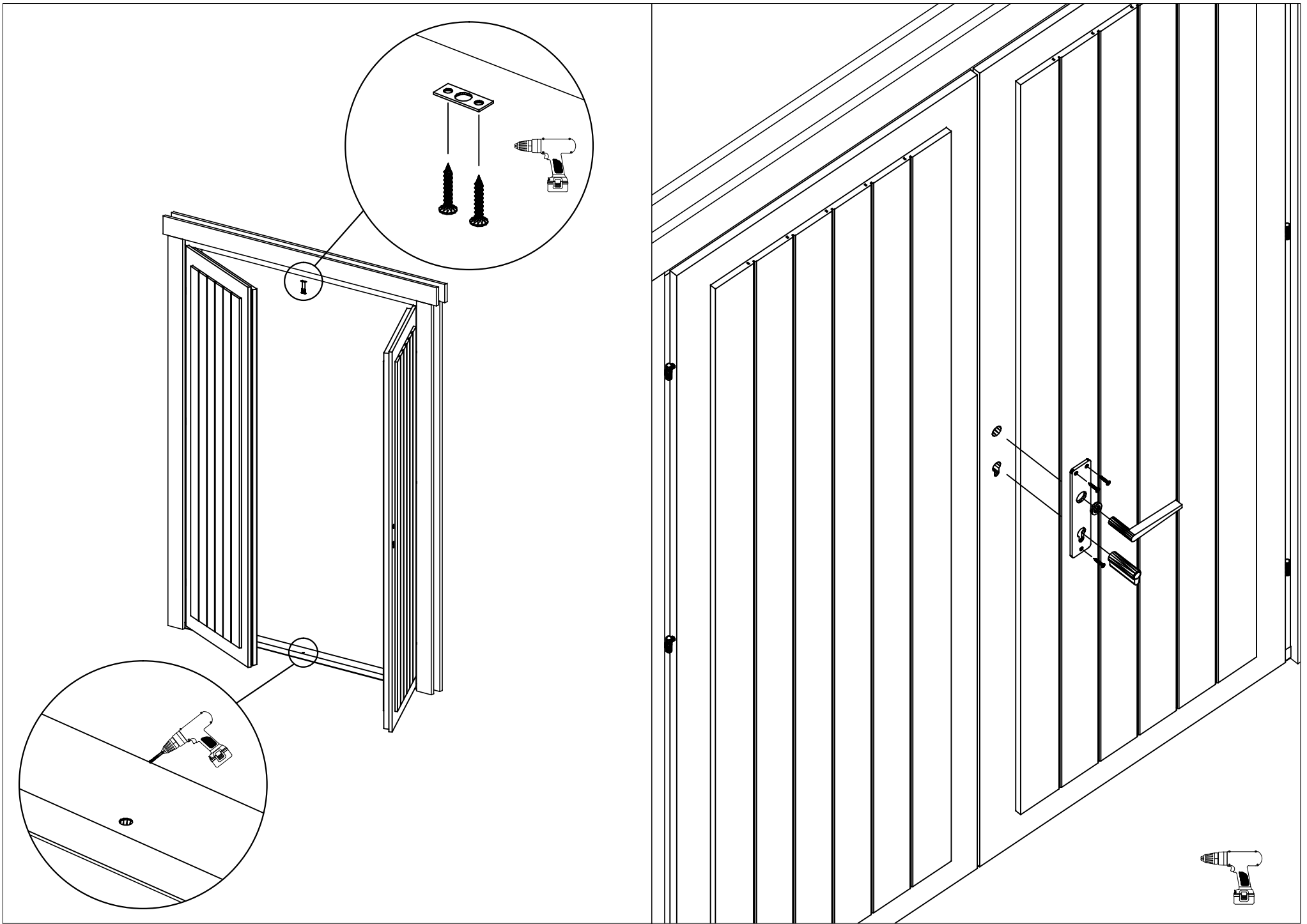

Vihmaliist / Head flashing / Regenschutz

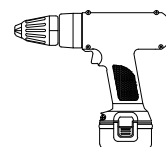
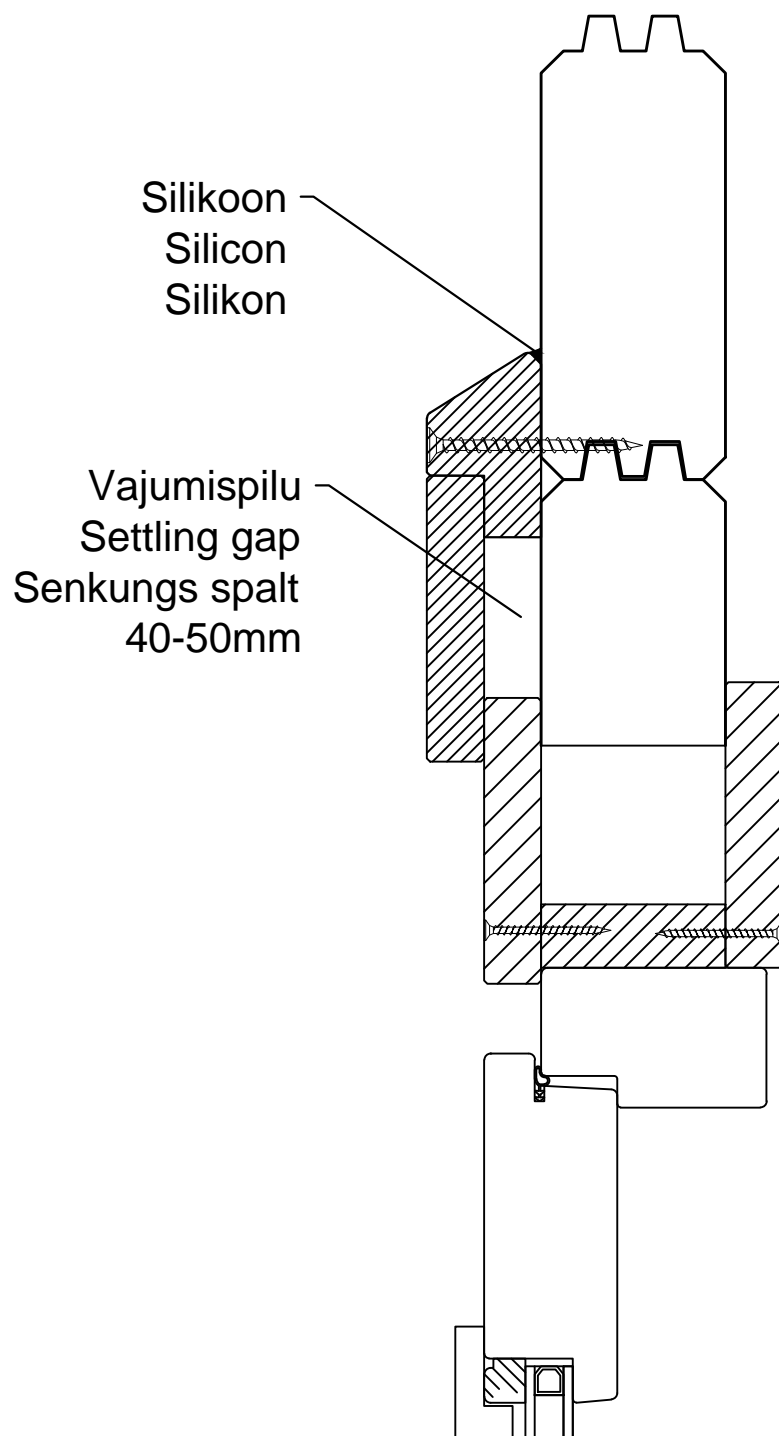

NB!

- Monteerida juhul kui ese on välja toodud maja spetsifikatsioonis!
- Install only if the item is listed in the house specification!
- Nur montieren wenn die Leiste in der Teilleiste gezeigt ist!