

Name

VS40_0173 300x448_40

Zeichnung/Drawing

3D

Profil/Profile

4.0x11.4

Datum/Date

20.03.2024

H = 1.700 m
TOTAL: 11.42 m²

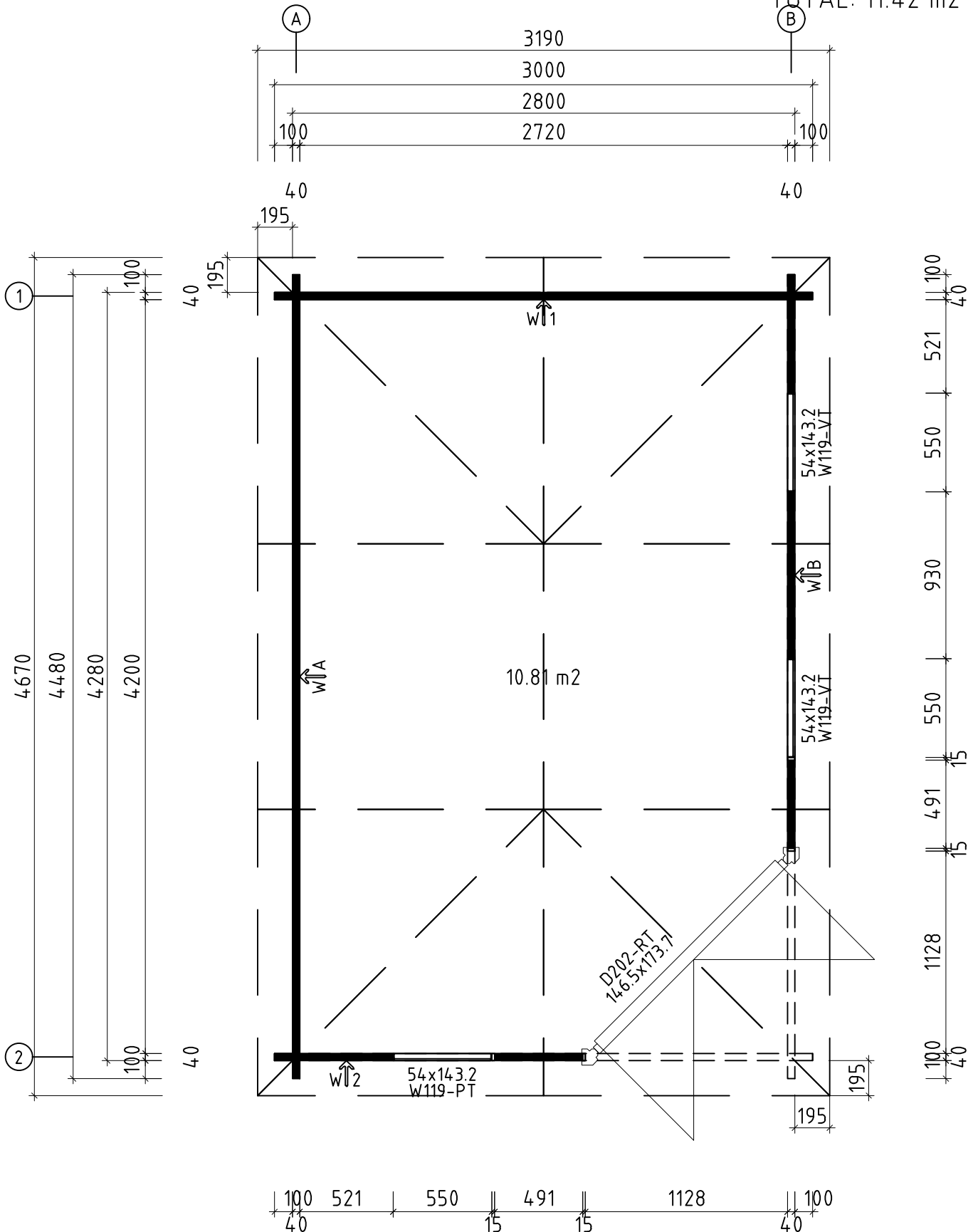

* Fenster und Türen sind ohne Sprossen
Windows and doors are without muntins





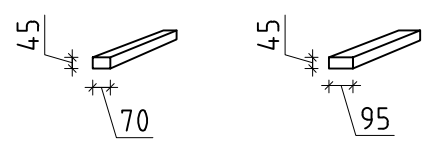
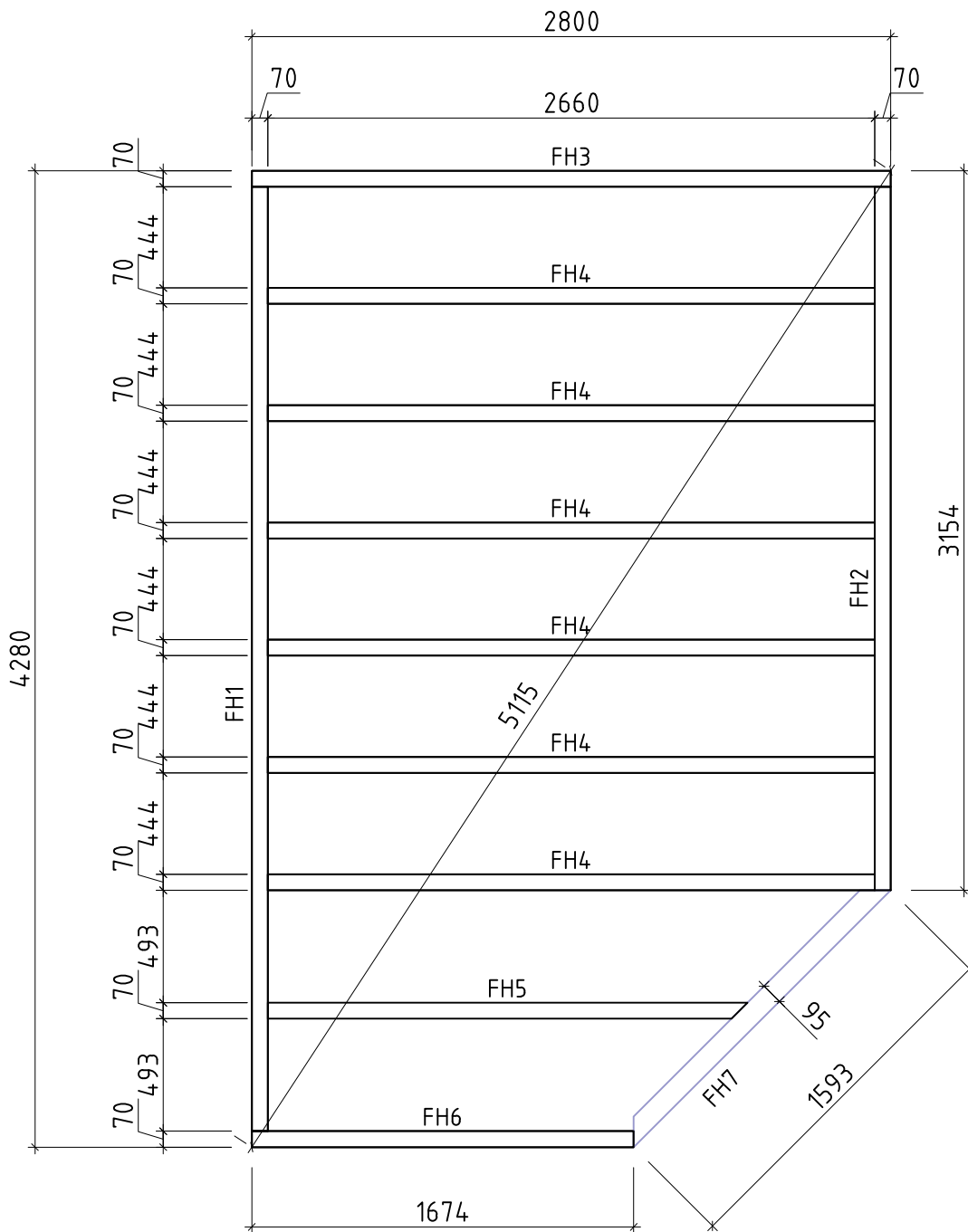

Q3 – Qualitätsklasse für Fenster und Türen/
Quality class for windows and doors

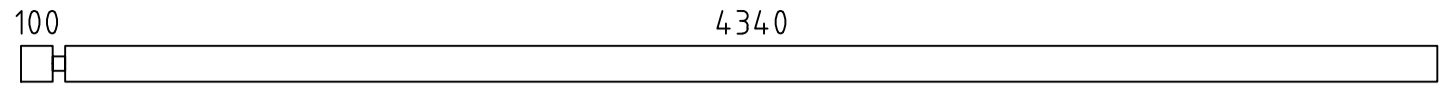
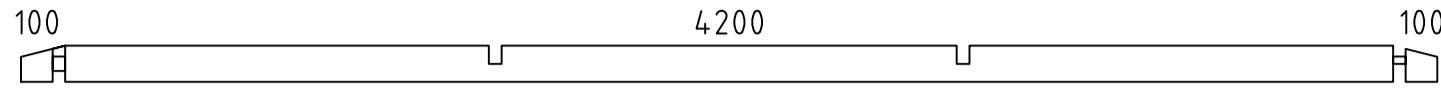
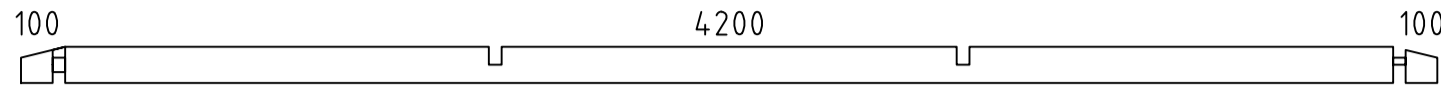
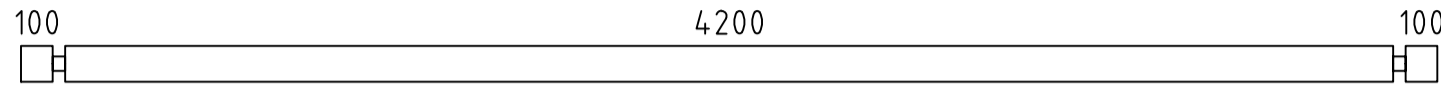
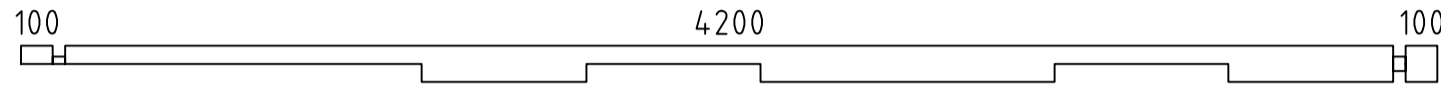
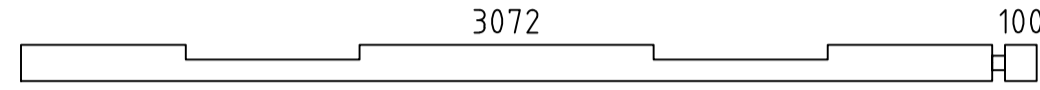
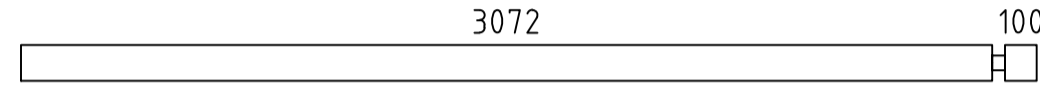
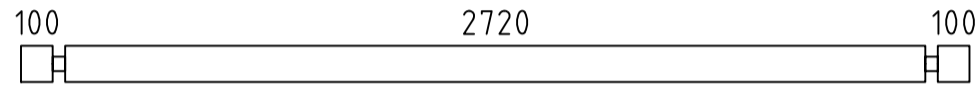
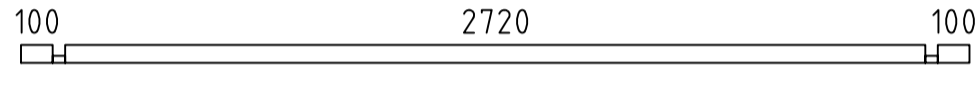
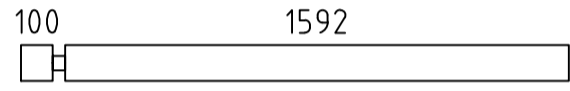
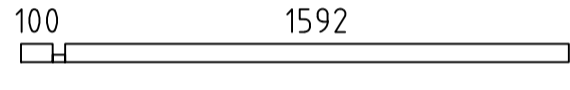
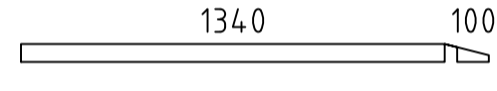
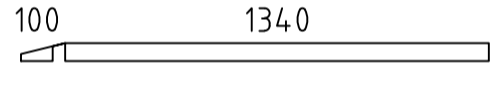
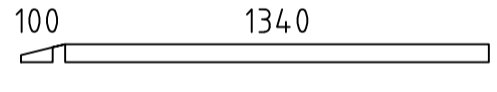
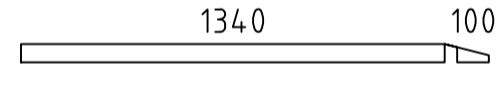
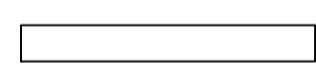
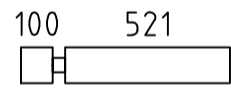
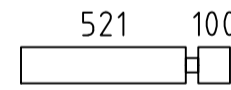
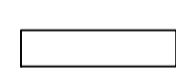
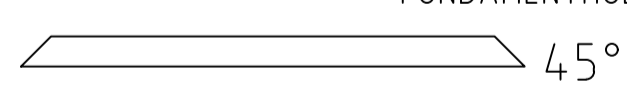
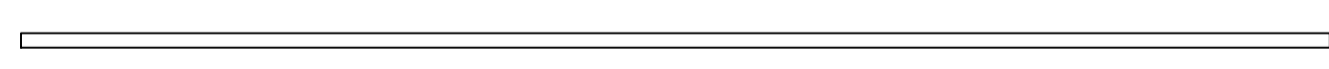
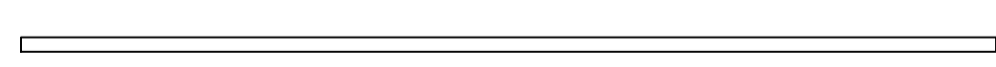
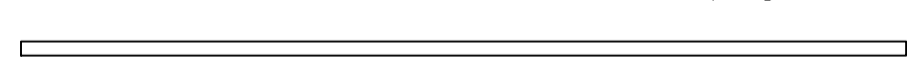
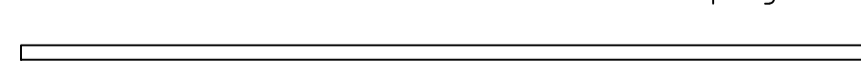
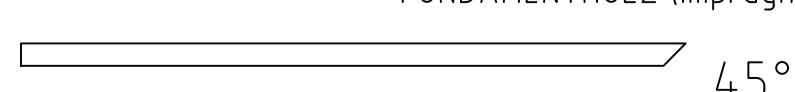

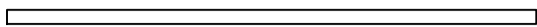

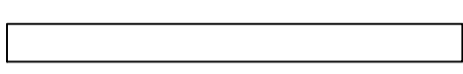

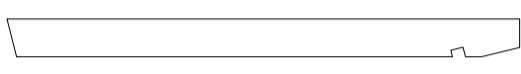
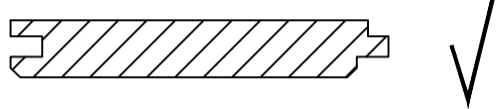
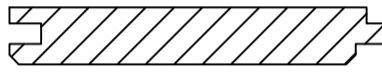
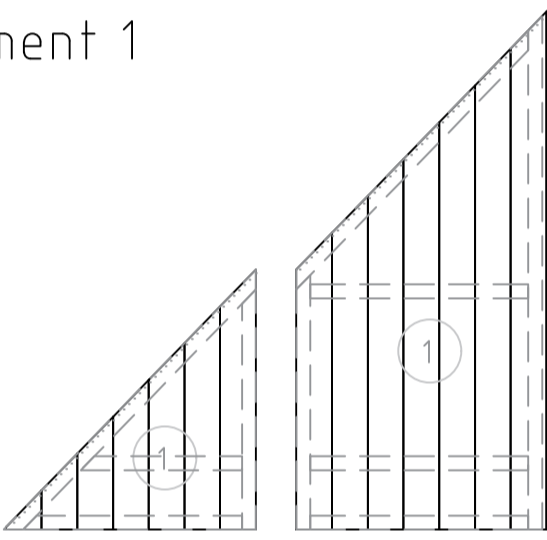
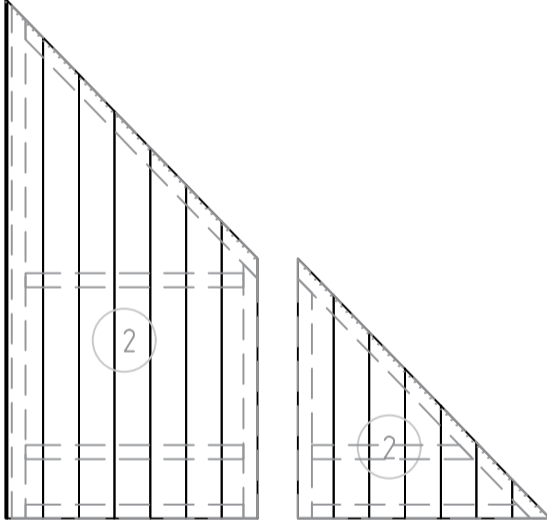
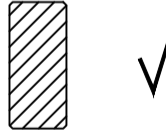
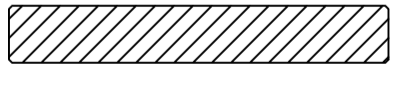
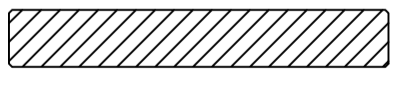

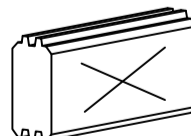
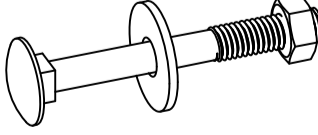
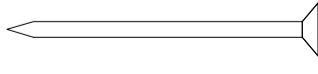
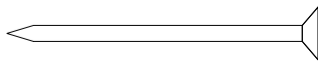

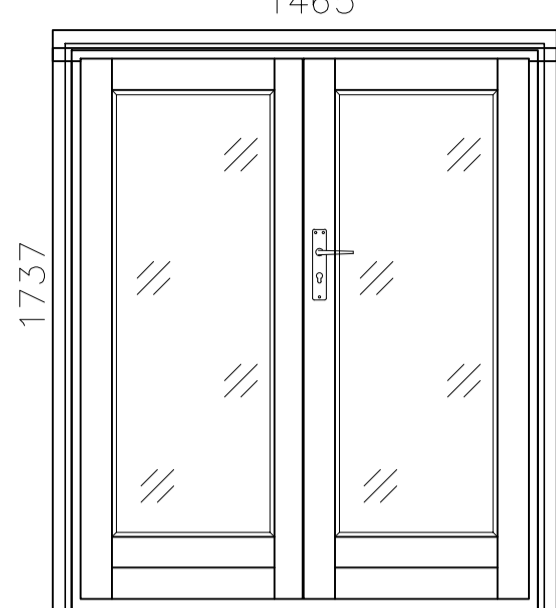
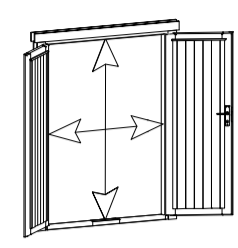
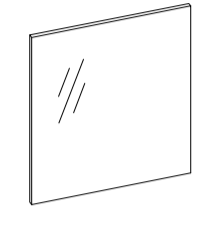

Name	VS40_0173 300x448_40		
Zeichnung/Drawing	Grundplan_Plan		
Profil/Profile	4.0x11.4	Datum/Date	20.03.2024

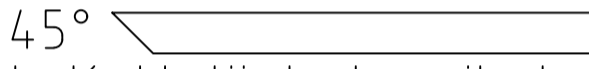
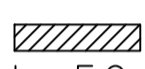

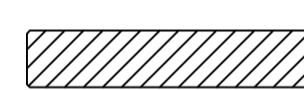
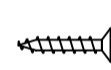
Name	VS40_0173 300x448_40		
Zeichnung/Drawing	Lagerholzplan_Foundation beams		
Profil/Profile	4.0x11.4	Datum/Date	20.03.2024

Pos	Teieliste/Specification VS40_0173 300x448_40		Stck Pcs.	Profil Profile (mm)	Länge Length (mm)
1extra			1	40x114	4480
001			1	40x114	4480
002			1	40x114	4480
003			18	40x114	4480
004			1	40x114	4480
005			1	40x114	3212
006			2	40x114	3212
007			19	40x114	3000
008			1	40x57	3000
009			2	40x114	1732
010			1	40x57	1732
011			1	40x57	1480
012			1	40x57	1480
013			1	40x57	1480
014			1	40x57	1480
015			12	40x114	930
016			13	40x114	661
017			12	40x114	661
018			25	40x114	491
FH7		FUNDAMENTHOLZ (imprägniert) - FOUNDATION BEAM (impregnated)	1	95x45	1585
FH1		FUNDAMENTHOLZ (imprägniert) - FOUNDATION BEAM (impregnated)	1	70x45	4140
FH2		FUNDAMENTHOLZ (imprägniert) - FOUNDATION BEAM (impregnated)	1	70x45	3084
FH3		FUNDAMENTHOLZ (imprägniert) - FOUNDATION BEAM (impregnated)	1	70x45	2800
FH4		FUNDAMENTHOLZ (imprägniert) - FOUNDATION BEAM (impregnated)	6	70x45	2660
FH5		FUNDAMENTHOLZ (imprägniert) - FOUNDATION BEAM (impregnated)	1	70x45	2102
Kood	VS40_0173 300x448_40		Materjal		Leht 1/7

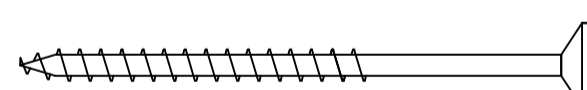
Pos	Teileliste/Specification VS40_0173 300x448_40		Stck Pcs.	Profil Profile (mm)	Länge Length (mm)
FH6	FUNDAMENTHOLZ (imprägniert) - FOUNDATION BEAM (impregnated) 		1	70x45	1674
LE2	LEISTE - LATH 		2	15x40	1472
LE1	LEISTE - LATH 		2	15x40	1358
LT2	LATTEN - STUDS 		2	44x120	1440
LT1	LATTEN - STUDS 		4	44x44	1440
PF1	PFETTEN - PURLINS 		1	44x120	1524
SPR1	SPARREN - RAFTERS 		6	40x120	1621
	FUSSBODENBRETTER - FLOOR BOARDS		25+1	113x18	4195
	DACHBRETTER - ROOF BOARDS		28+1	113x18	1644
	Dachelement - Roof element 1 		4		
	Dachelement - Roof element 2 		4		
	FUSSBODENLEISTEN - FLOOR STRIPS			18x40	15
T02-1	TRAUFENBRETTER - EAVES BOARDS 18x120		2	18x120	3300
T02-2	TRAUFENBRETTER - EAVES BOARDS 18x120		2	18x120	4800
SM-1	Sturmleisten - Storm reinforcement 		4	18x40	1939
SH	SCHLAGHÖLZER - MOUNTING PIECES 		3		
SS024	Schloßschrauben - Wood bolts M8x70 Mutter - Nut M8 U-Scheibe - Washer Ø25 (für Sturmleisten - storm reinforcement) 		12		
NG2 550	NÄGEL - NAILS 2.5x50 Dachbretter - Roof boards 		224		
NG2 550	NÄGEL - NAILS 2.5x50 Fussbodenbretter - Floor boards 		450		
Kood	VS40_0173 300x448_40		Materjal		Leht 2/7

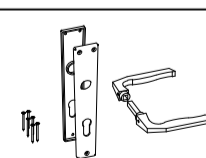
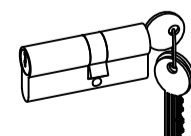
Pos	Teieliste/Specification VS40_0173 300x448_40		Stck Pcs.	Profil Profile (mm)	Länge Length (mm)
	<p>TÜR/DOOR 1465x1737 D3-M40R-0XT-14651737</p> <p>Q3 D202-RT 1465</p>  <div style="display: flex; justify-content: space-between;"> <div style="width: 45%;"> <p>Right handed / DIN rechts / paremakäeline</p> <p>Clear opening/ durchgangsmaß/ ava suurus 1337x1629mm</p> <p>double-pane tempered glass gehärtete ISO Glas 2-fach 2x klaaspakett, karastatud</p> </div> <div style="width: 45%;">   <p>492x1361mm</p> </div> </div>		1		
DzT40 -01-1	CD- cover strip for door - ET- Deckbrett zum Tür - NU- Katteliist ukse kohale 40		1	18x40	1585
P9L1 -01-1	CD- left hand doorpost - ET- linke Türpfoste - NU- vasak uksepost 40		1	90x90	1777
P9R1 -01-1	CD- right hand doorpost - ET- rechte Türpfoste - NU- parem uksepost 40		1	90x90	1777
VK1- 01-1	CD- trim strips for canopy element - ET- Verkleidungsleisten für Vordachelement - NU- Katteliistud varikatusele 58	  ✓	2	58x18	1110
PL1-1	Trims - Rahmenleisten - Piirdeliistud 18x40	 ✓	1	18x40	1540
PL2-1	Trims - Rahmenleisten - Piirdeliistud 18x58	 ✓	4	18x58	1717
PL3-1	Trims - Rahmenleisten - Piirdeliistud 18x95	 ✓	1	18x95	1540
SR25 15-01	2.5x15 Locking plate - Schließblech - Riivi vastus 01 Q2-Q3		2		
SR35 45-05	3.5x45 Canopy element - Vordachelement - Varikatus		6		
SR35 45-03	3.5x45 Cover strip - Deckbrett - Katteliist ukse kohale		3		
SR35 45-04	3.5x45 Trim strips - Verkleidungsleiste - Katteliist varikatusele		6		
SR35 45-01	3.5x45 Trims - Rahmleisten - Piirdeliistud		24		
SR50 90-01	5.0x90 Door frames - Türrahmen - Ukselengid		8		
VE1-01	CD- canopy element - ET- Vordachelement - NU- Varikatus uksele 1435x745		1		
RV01	Locking plate - Schließblech - Riivi vastus 01 Q2-Q3		1		
UL-Q 2-Q3	Q2-Q3 Door handle - Türgriff - Ukselink		1		
LS-Q4	Q4 Cylinder lock - Zylinderschloss - Lukusüdamik		1		
Kood	VS40_0173 300x448_40	Materjal		Leht	6/7

VS40_0173 300x448_40

Zuschneiden der
Fussbodenbretter 113x18mm

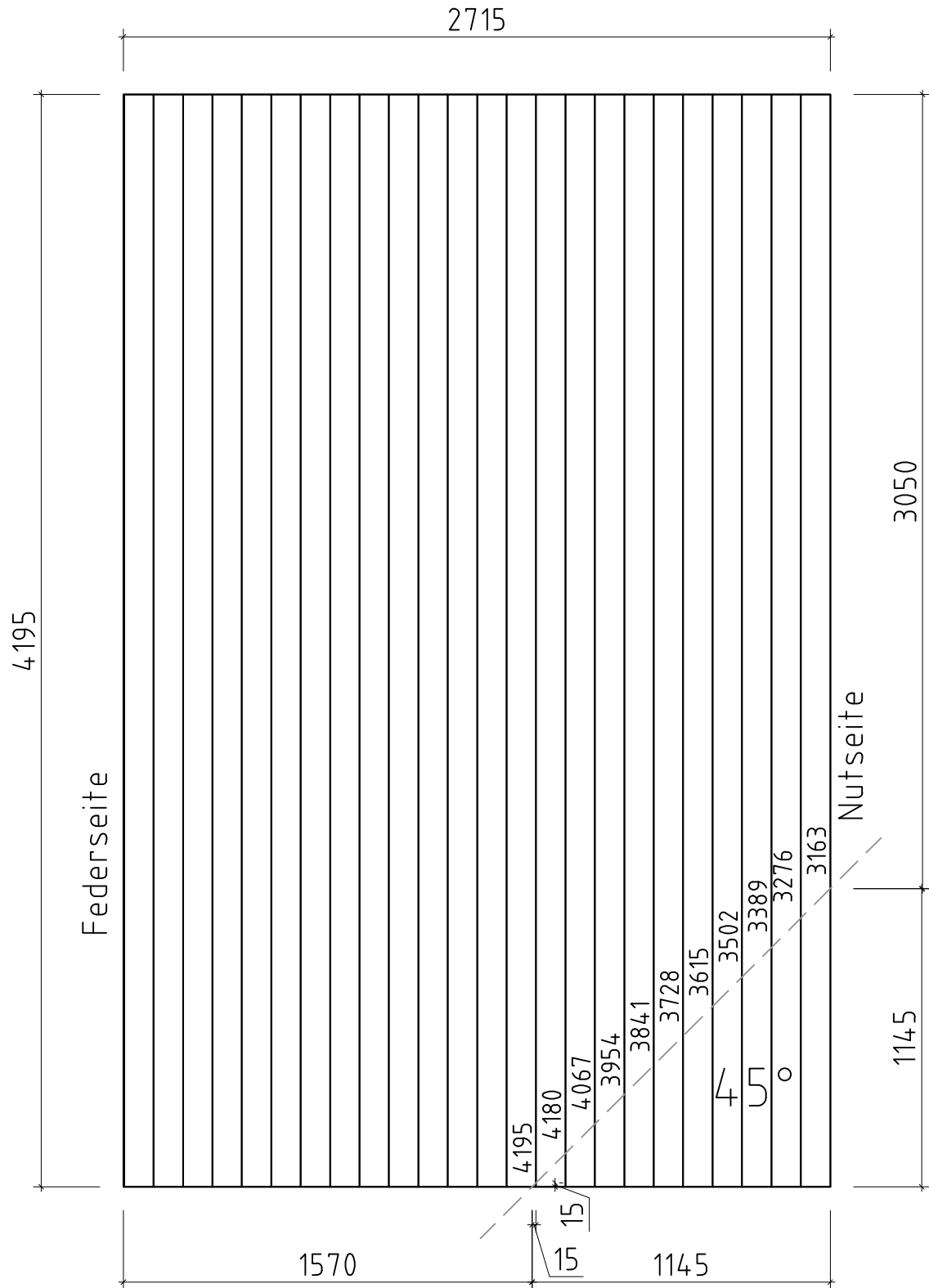

VS40_0173 300x448_40

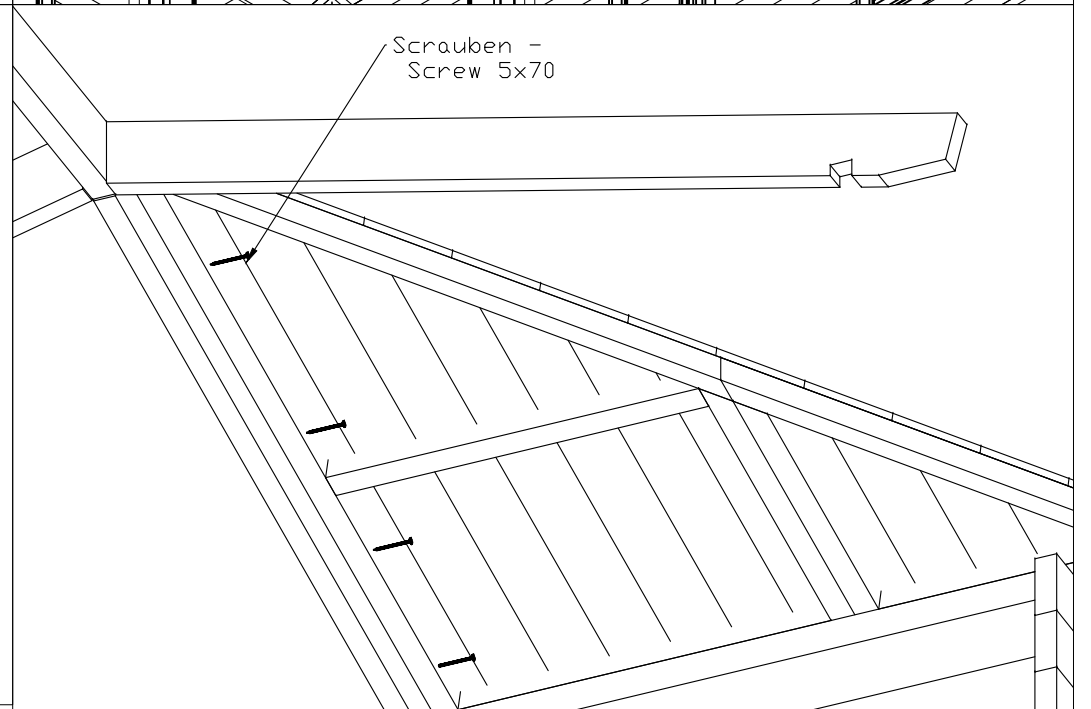
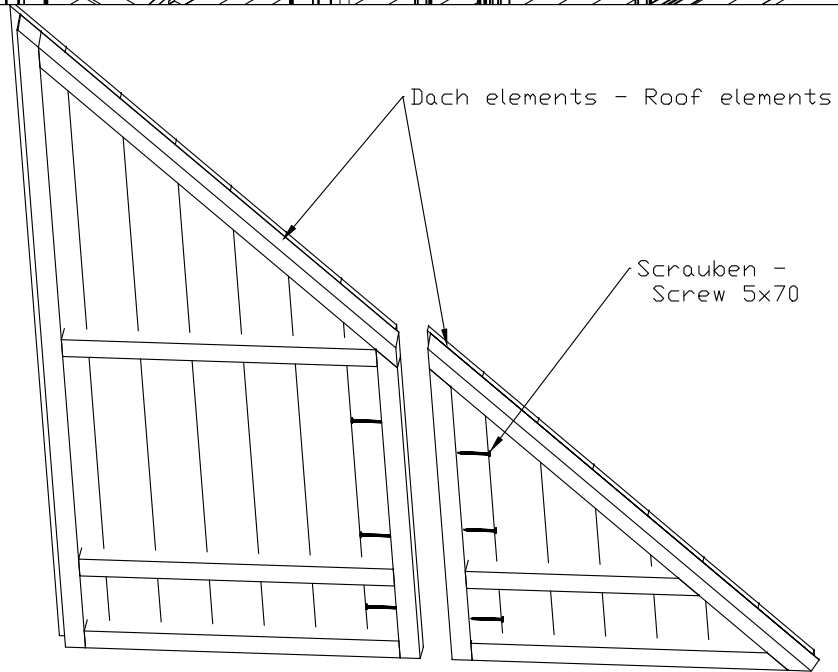
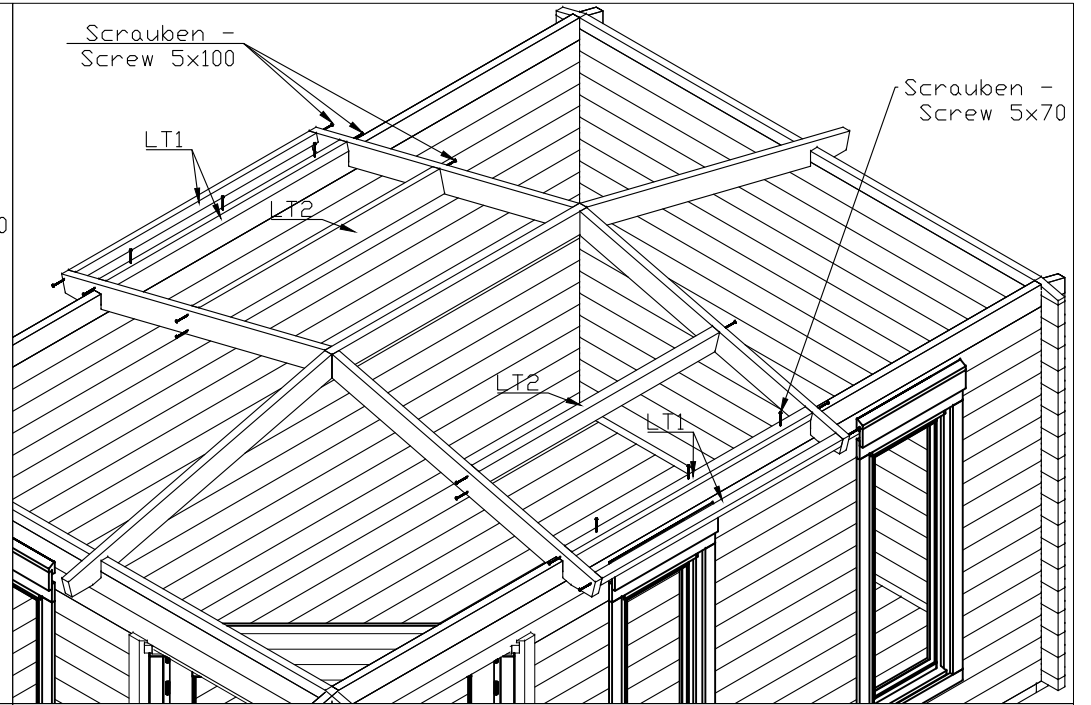
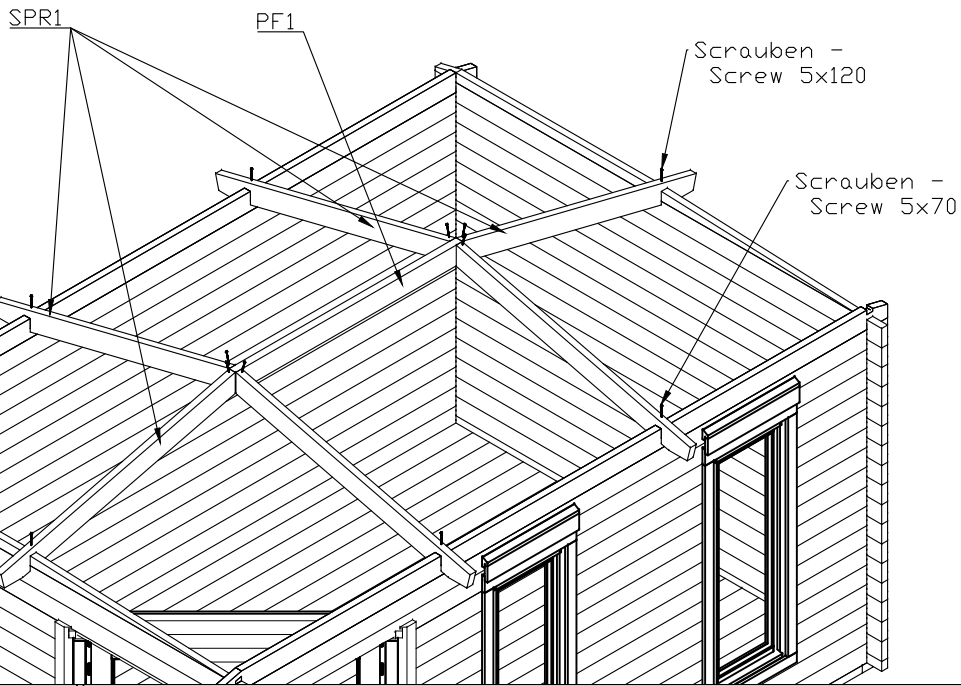

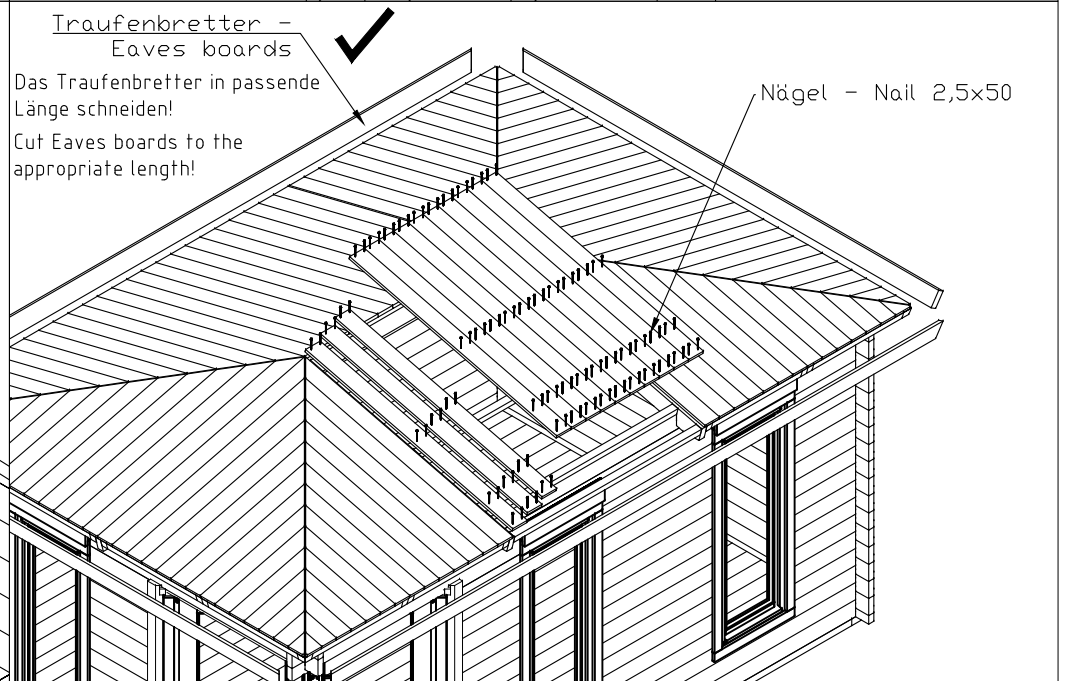
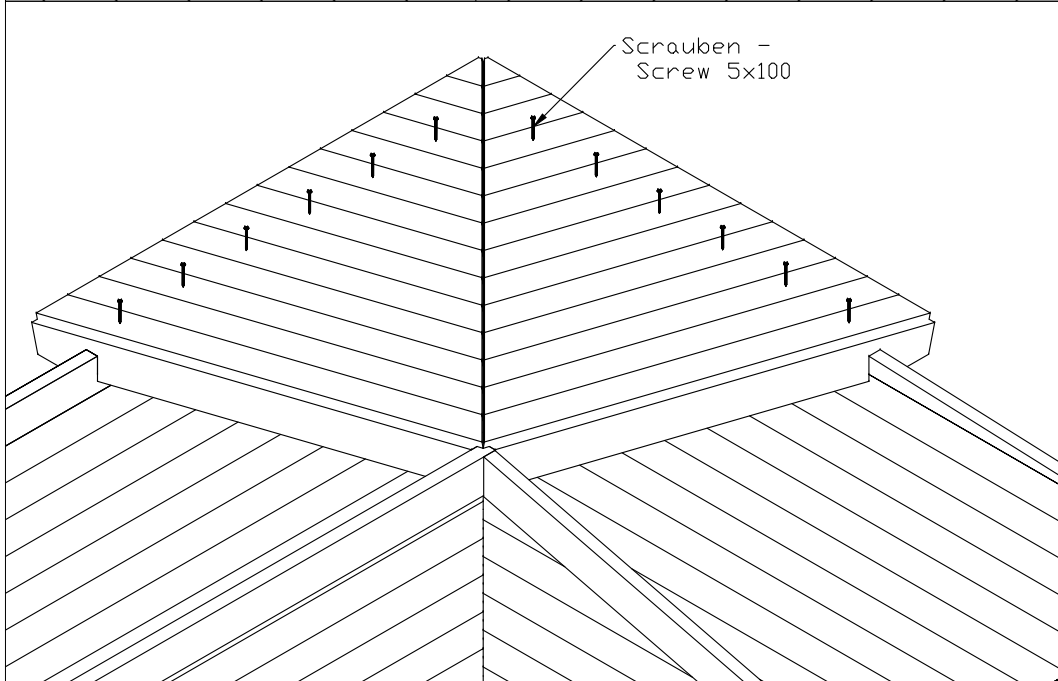
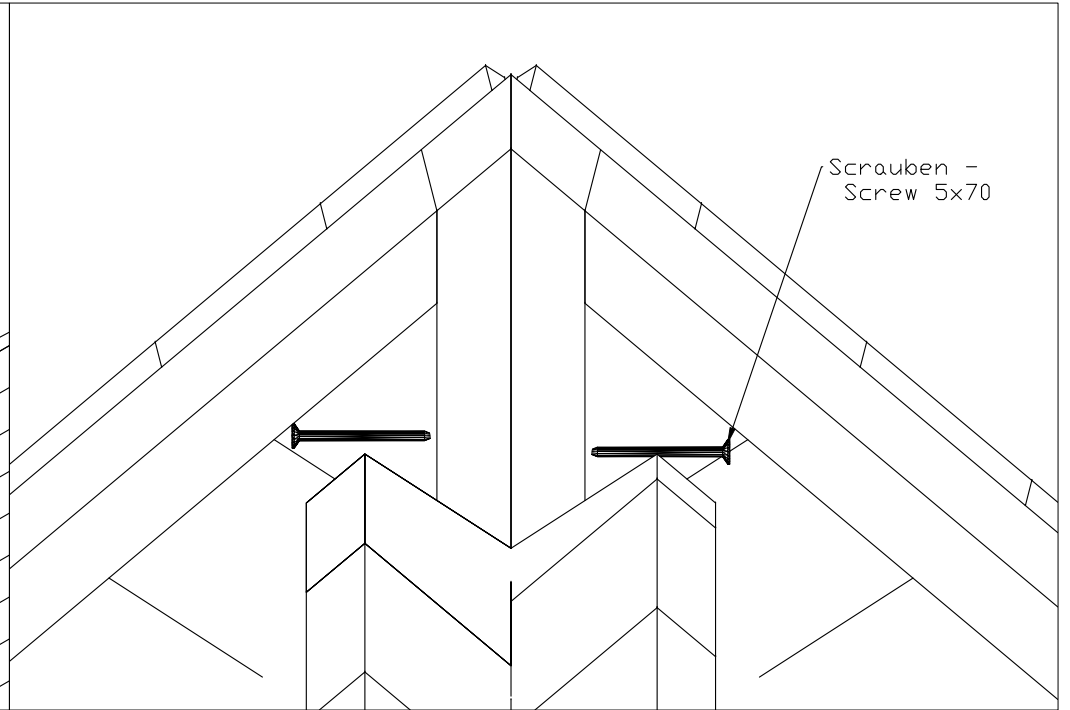
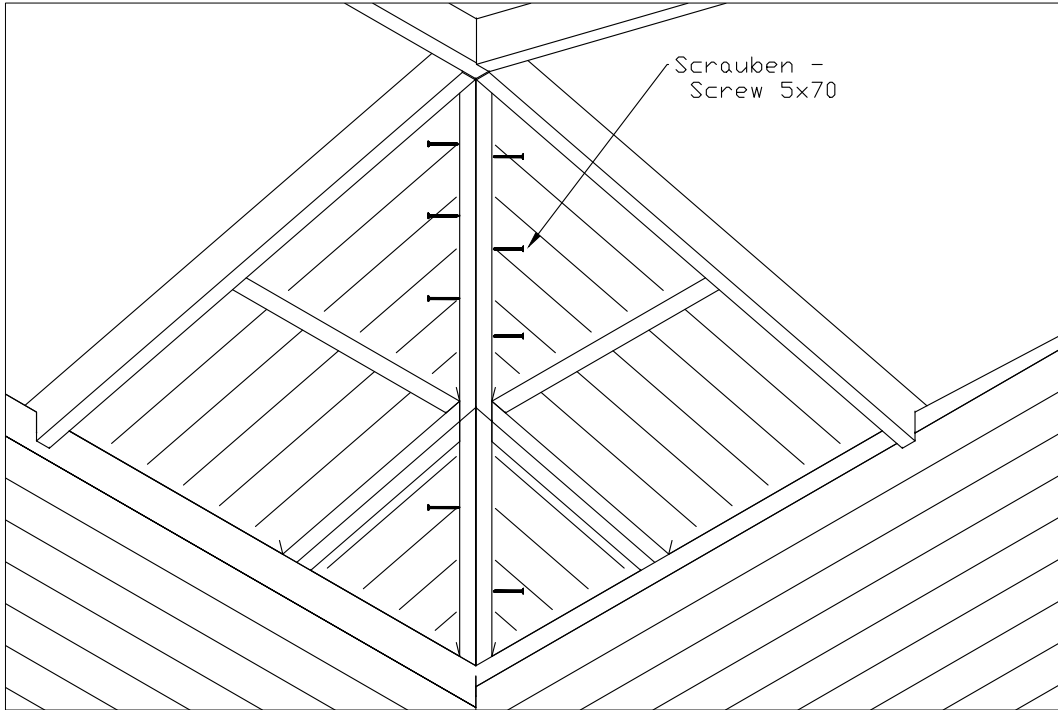

Vihmaliist / Rain strip / Wasserleiste

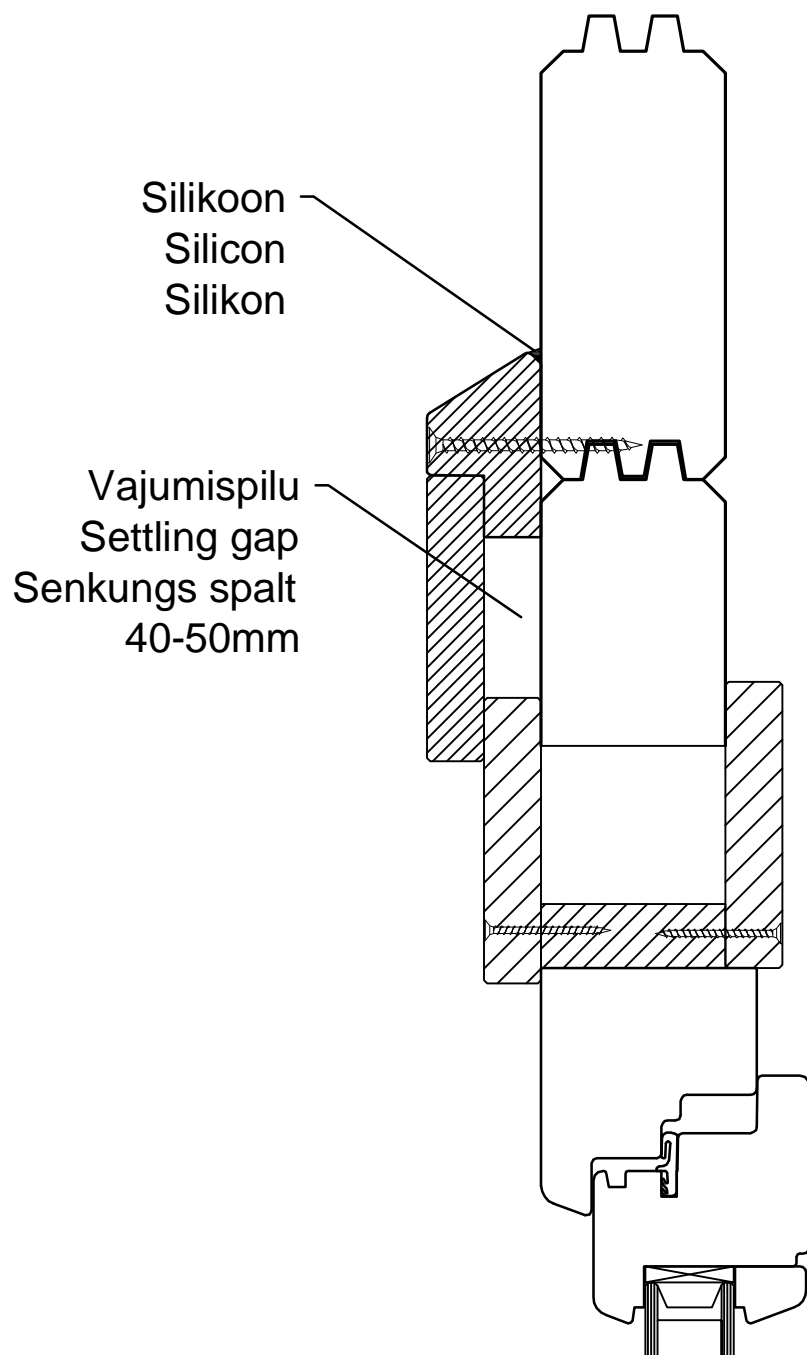

NB!

- Monteerida juhul kui ese on välja toodud maja spetsifikatsioonis!
- Install only if the item is listed in the house specification!
- Nur montieren wenn die Leiste in der Teileliste gezeigt ist!

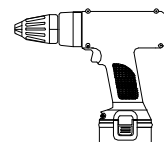

Ukse montaa 0 / Tür montage / Door assembly
(GH+ / SH)

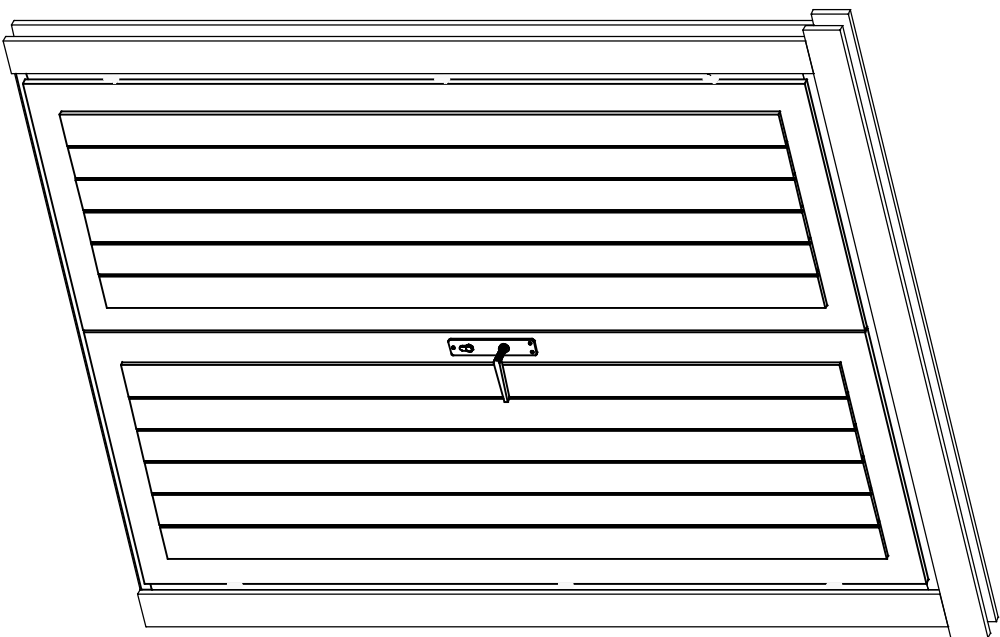

4.5x90

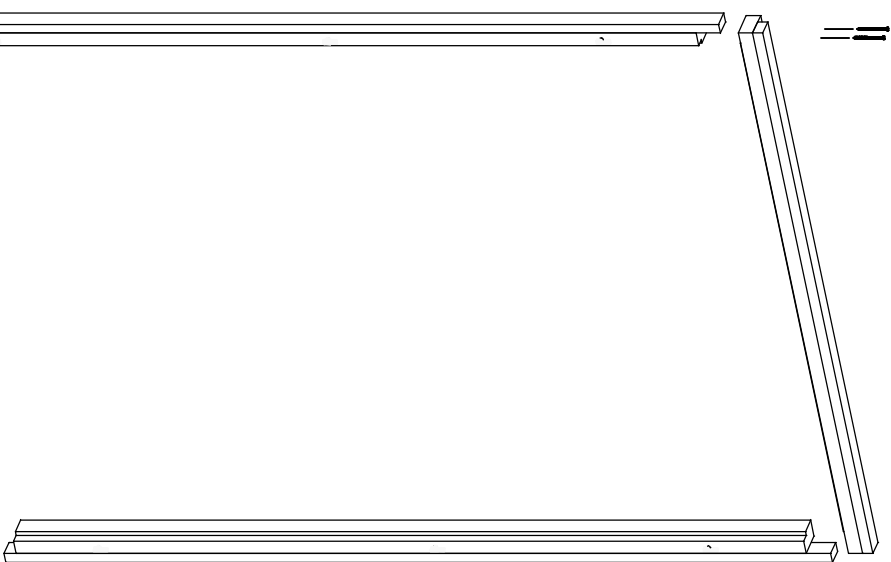

4.5x90



3.5x45

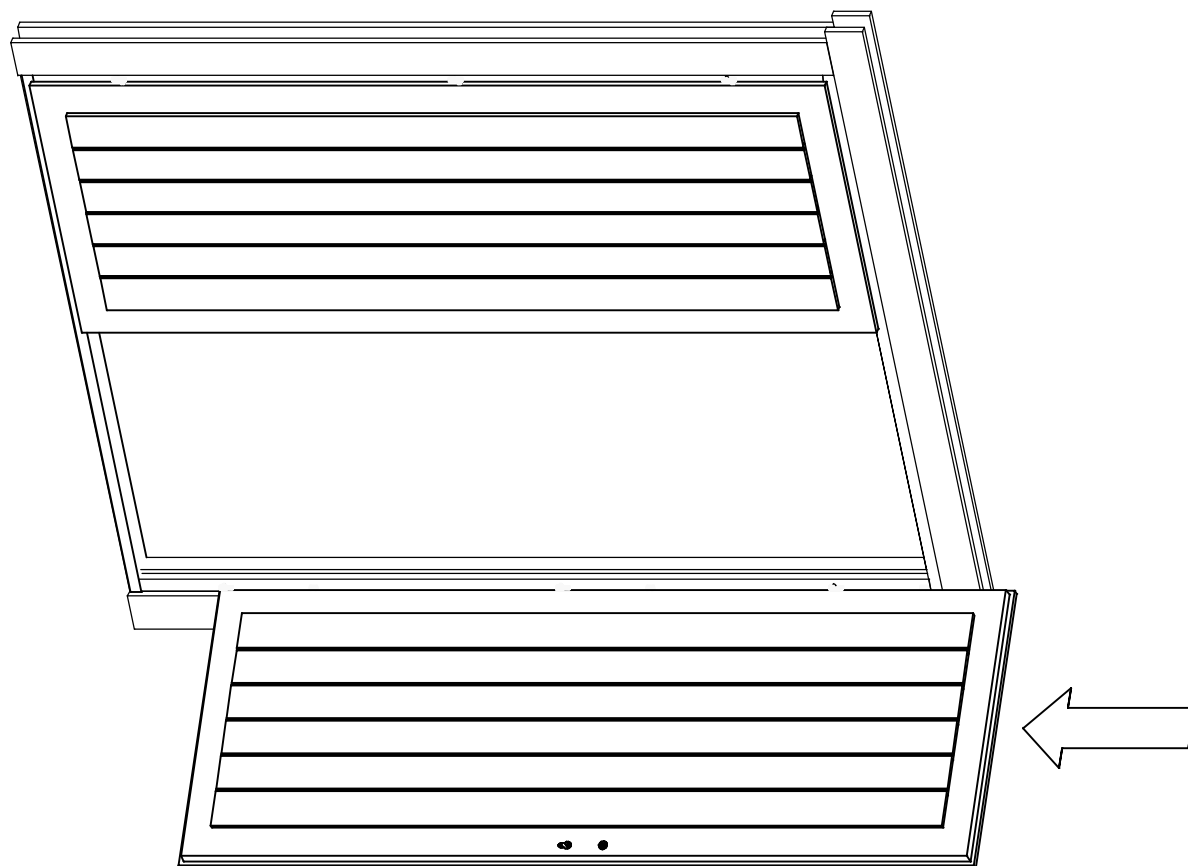
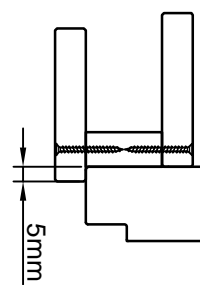
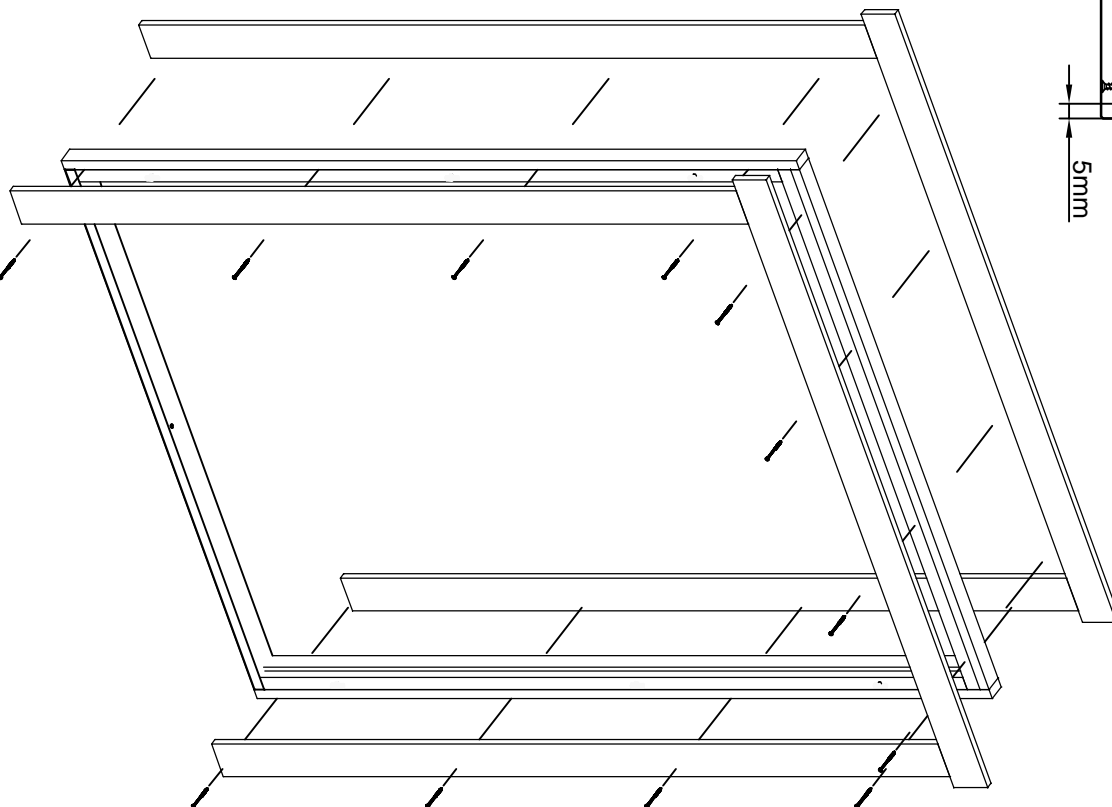

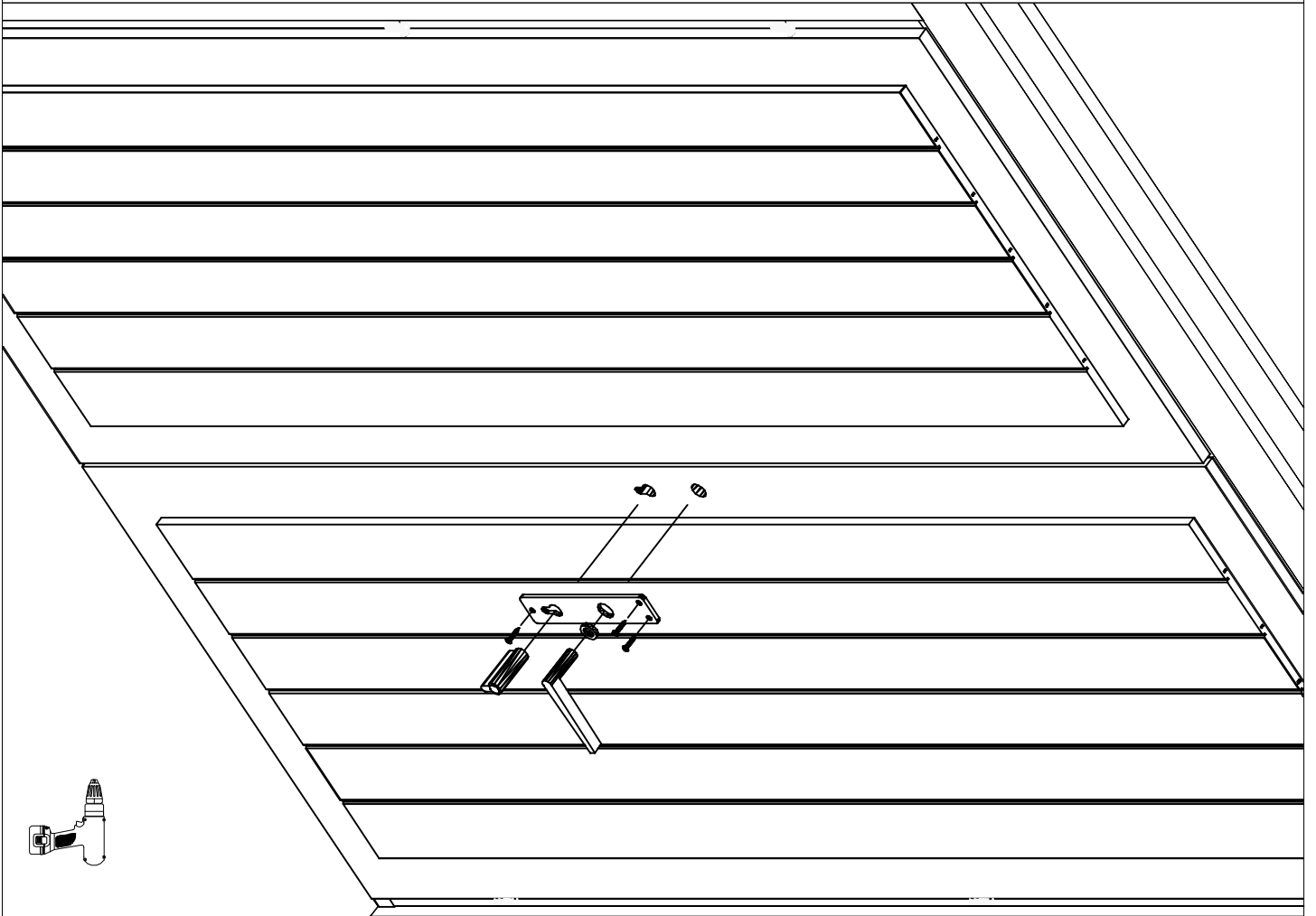
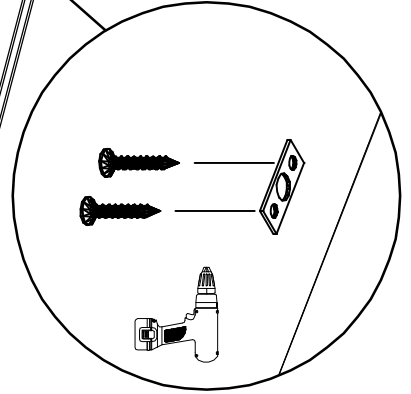
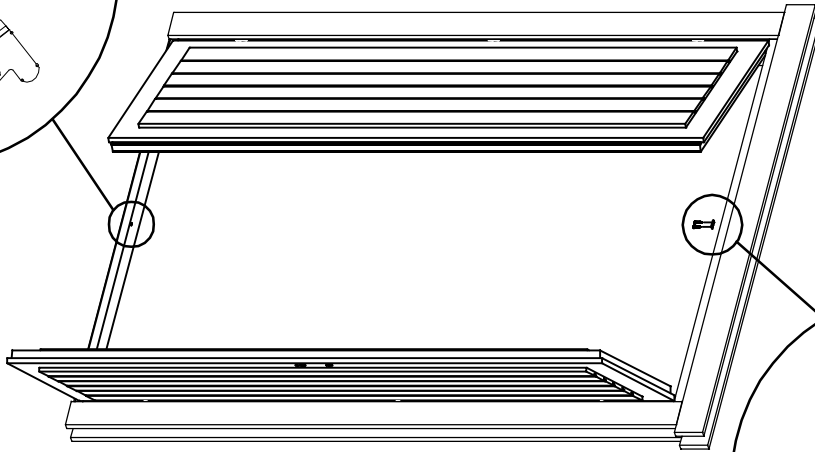
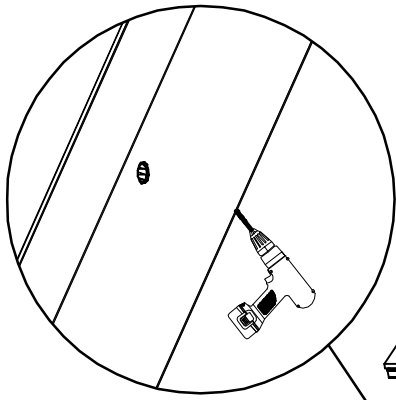

1. samm: Ukse varikatus kinnitada seinale.
Step 1: Dachelement an den Wänden verschrauben.
Step 1: Screw canopy element to the wall.

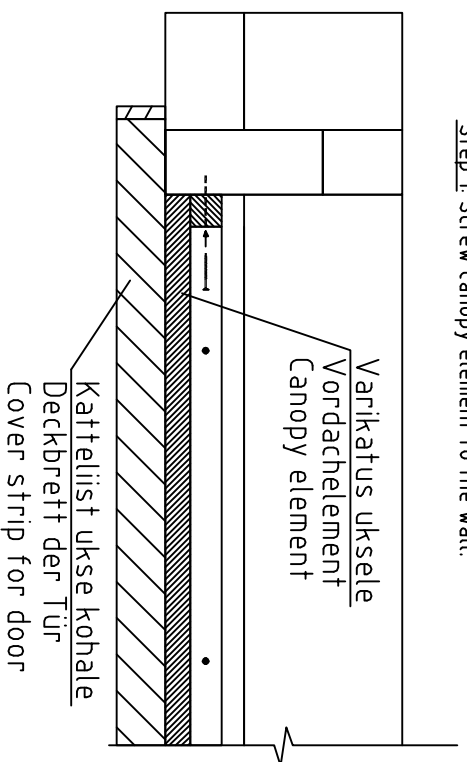

2. samm: Katteliist tuleb kinnitada läbi varikatuse asetusega külgepidi vastu ukseleistu.

- Step 2: Das Deckbreitt muss von oben (durch das VD-Element) an das Dach-element verschraubt werden.
Step 2: Fasten cover strip to the canopy element.

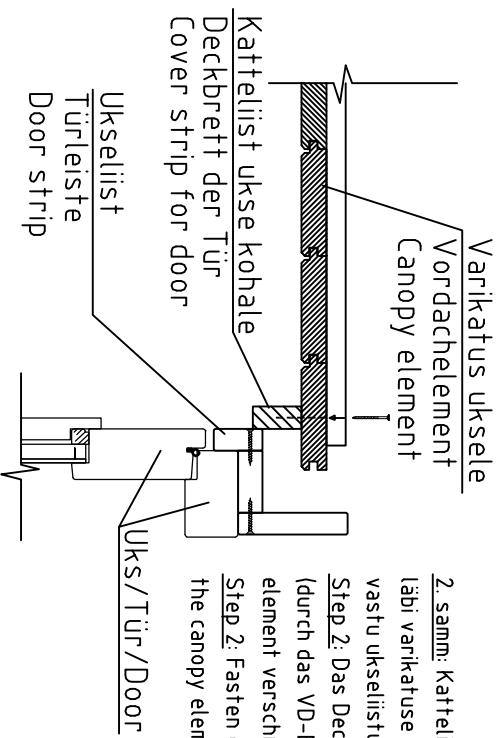

3. samm: Katteliistud tuleb lõigata möötu ja siis paigaldada seinale ja varikatuse ühenduskoha alla.

- Step 3: Die Verkleidungsleisten in die richtige Länge schneiden und unter das VD-Element befestigen.

- Step 3: Cut trim strips to size and fasten under the canopy element.

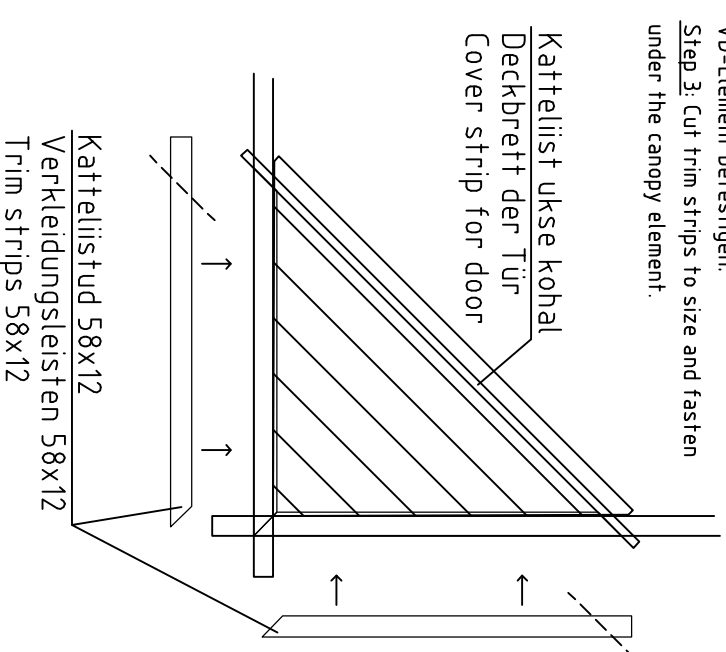

Varikatus uksele/Vordachelement/Canopy element

Lõige/Schnitt/Section

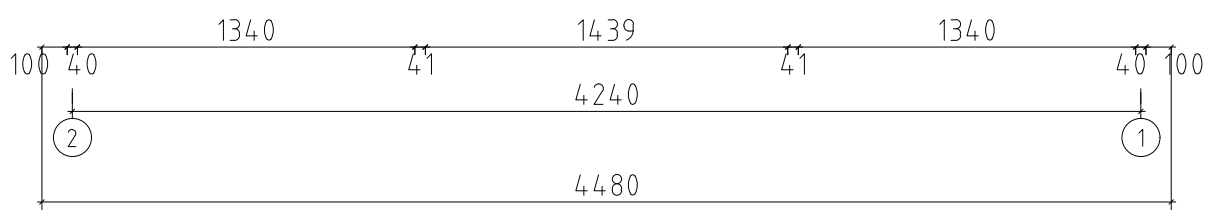
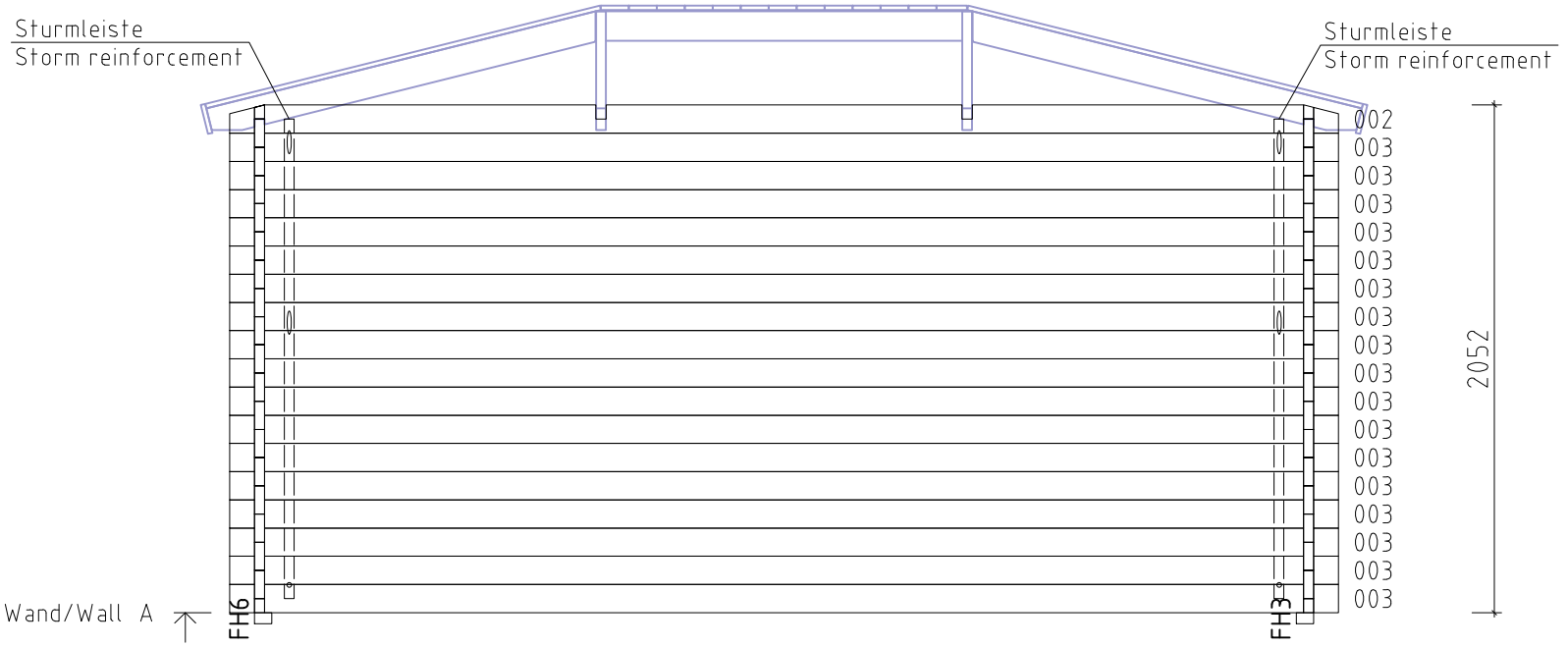

Name	VS40_0173 300x448_40		
Zeichnung/Drawing	WAND/WALL A		
Profil/Profile	4.0x11.4	Datum/Date	20.03.2024

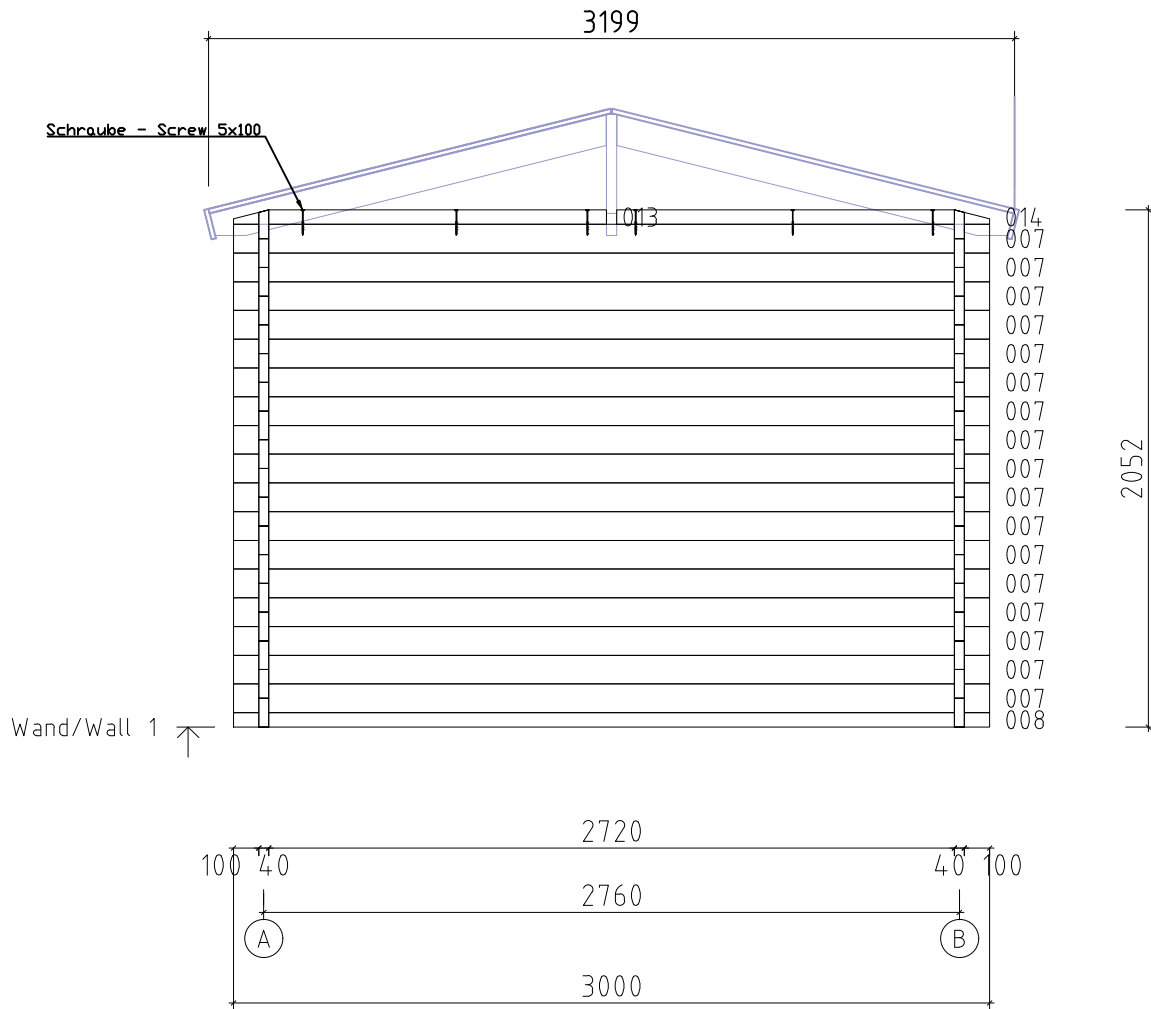

Name	VS40_0173 300x448_40		
Zeichnung/Drawing	WAND/WALL 1		
Profil/Profile	4.0x11.4	Datum/Date	20.03.2024

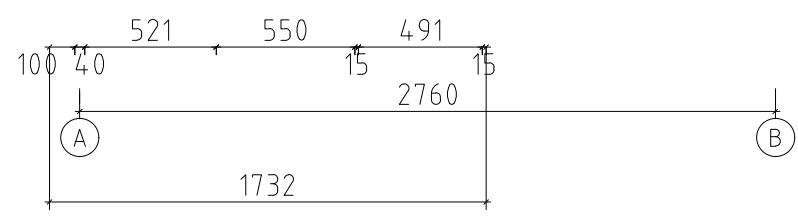
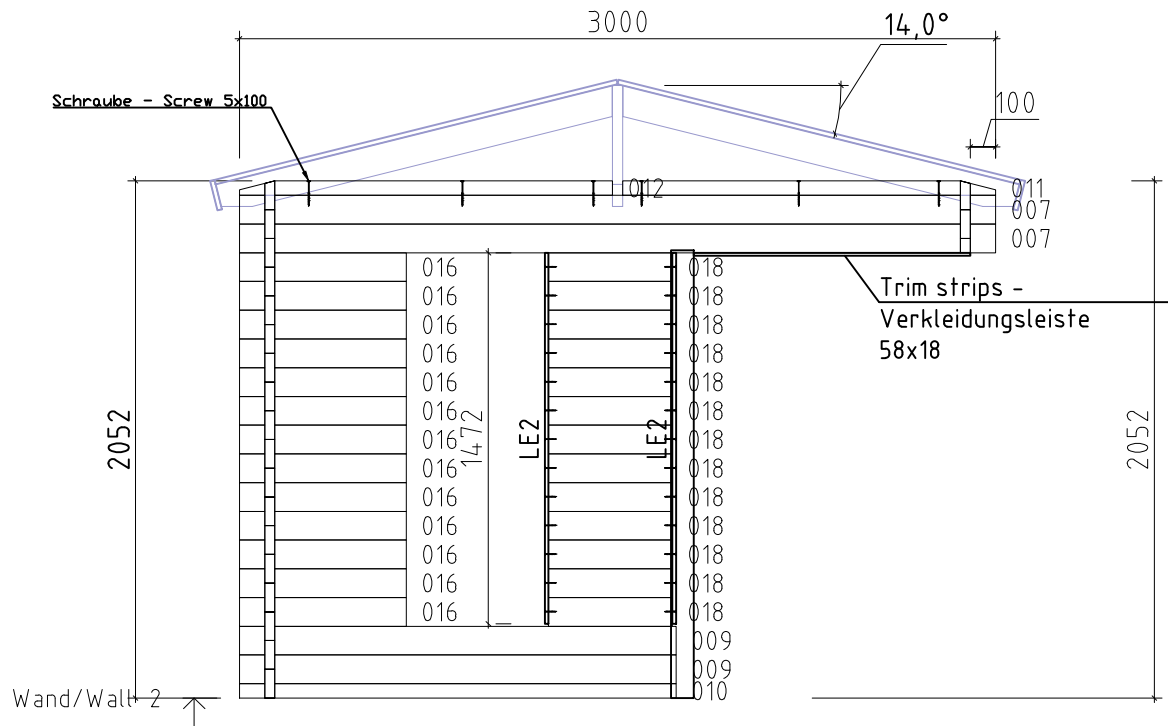

Name	VS40_0173 300x448_40		
Zeichnung/Drawing	WAND/WALL 2		
Profil/Profile	4.0x11.4	Datum/Date	20.03.2024